

Printing: March 2024 (01)
Publication No.: OM24EN-HT33E0EUR
Printed in France
Nissan Automotive Europe SAS - France



HT33-EN4

NISSAN X-TRAIL

HT33-EN4



X-TRAIL

OWNER'S MANUAL

Foreword

This manual was prepared to help you understand the operation and maintenance of your vehicle so that you may enjoy many kilometers (miles) of driving pleasure. Please read through this manual before operating your vehicle.

A separate Warranty Information & Maintenance Booklet explains details about the warranties covering your vehicle.

Your NISSAN dealer or qualified workshop knows your vehicle best. When you require any service or have any questions, we will be glad to assist you with the extensive resources available for you.

IMPORTANT SAFETY INFORMATION

Reminders for safety!

Follow these important driving rules to help ensure a safe and complete trip for you and your passengers!

- **NEVER drive under the influence of alcohol or drugs.**
- **ALWAYS observe posted speed limits and never drive too fast for conditions.**
- **ALWAYS use your seat belts and appropriate child restraint systems. Preteen children should be seated in the rear seat.**
- **ALWAYS provide information about the proper use of vehicle safety features to all occupants of the vehicle.**
- **ALWAYS review this Owner's Manual for important safety information.**

When reading the manual

This manual includes information for all options available on this model. Therefore, you may find some information that does not apply to your vehicle.

Throughout this manual, some illustrations may only show the layout for Left-Hand Drive (LHD) models. For Right-Hand Drive (RHD) models, the illustrated shape and location of some components may differ.

All information, specifications and illustrations in this manual are those in effect at the time of printing. NISSAN reserves the right to change specifications or designs without notice and without obligation.

MODIFICATION OF YOUR VEHICLE

This vehicle should not be modified. Modification could affect its performance, safety or durability, and may even violate governmental regulations. In addition, damage or performance problems resulting from modifications may not be covered under NISSAN warranties.


WARNING


Installing an aftermarket On-Board Diagnostic (OBD) plug-in device that uses the port during normal driving, for example remote insurance company monitoring, remote vehicle diagnostics, telematics or e-POWER system, may cause interference or damage to vehicle systems. We do not recommend or endorse the use of any aftermarket OBD plug-in devices, unless specifically approved by NISSAN. The vehicle

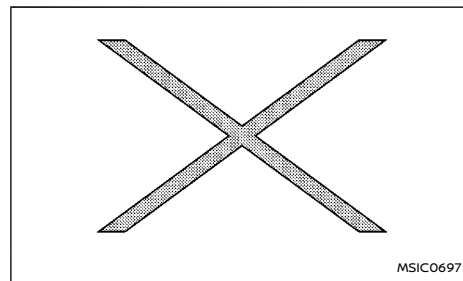
warranty may not cover damage caused by any aftermarket plug-in device.

Read first — then drive safely

Before driving your vehicle, read this Owner's Manual carefully. This will ensure familiarity with controls and maintenance requirements, assisting you in the safe operation of your vehicle.

Throughout this manual we have used the symbol  followed by the word **WARNING**. This is used to indicate the presence of a hazard that could cause death or serious personal injury. To avoid or reduce the risk, the procedures must be followed precisely.

The symbol  followed by the word **CAUTION** is also used throughout this manual to indicate the presence of a hazard that could cause minor or moderate personal injury or damages to your vehicle. To avoid or reduce the risk, the procedures must be followed carefully.



If you see this symbol, it means **“Do not do this”** or **“Do not let this happen”**.



If you see a symbol similar to these in an illustration, it means the arrow points to the front of the vehicle.



Arrows in an illustration that are similar to these indicate movement or action.



Arrows in an illustration that are similar to these call attention to an item in the illustration.

Trademarks:

QR code

The term “QR code” is a registered trademark of DENSO WAVE INCORPORATED in Japan and other countries.

Air bag warning label:



“NEVER use a rearward facing child restraint on a seat protected by an ACTIVE AIR BAG in front of it, DEATH or SERIOUS INJURY to the CHILD can occur.”

Be sure to read “Air bag warning labels” (P.60).

© 2024 NISSAN MOTOR CO., LTD.

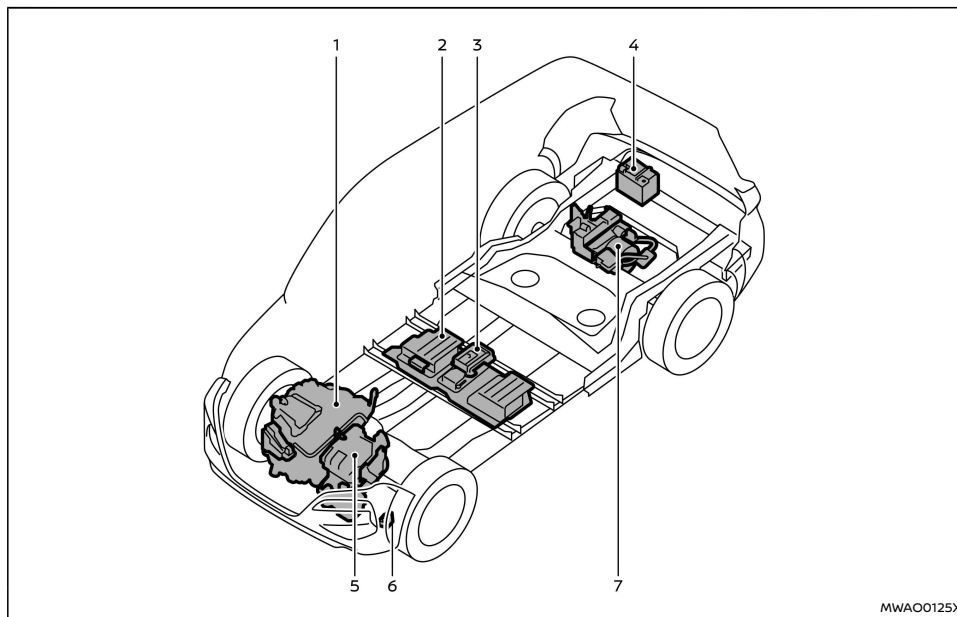
Contents

	e-POWER System
e-POWER system overview	
Illustrated table of contents	0
Safety – seats, seat belts and supplemental restraint system	1
Instruments and controls	2
Pre-driving checks and adjustments	3
Monitor, heater, air conditioner, audio and phone systems	4
Starting and driving	5
In case of emergency	6
Appearance and care	7
Maintenance and do-it-yourself	8
Technical information	9
Regulatory Information	10
Index	11

e-POWER SYSTEM OVERVIEW

NISSAN e-POWER system	2	Efficient use of your vehicle	8
Electric motors	3	Before driving	8
Lithium ion (Li-ion) battery	3	When driving	8
Regenerative brake	3	e-Pedal Step	9
When the vehicle starts the engine	4	e-Pedal Step system operation	10
e-POWER system precautions	5	e-Pedal Step system limitations	11
High voltage components	5	e-Pedal Step system malfunction	11
e-POWER system characteristics	6	EV mode	11
Road accident cautions	7	Approaching Vehicle Sound for Pedestrians (VSP) system	12
Emergency shut-off system	8		

NISSAN e-POWER SYSTEM



MWA00125X

- | | |
|--|--|
| <ol style="list-style-type: none"> 1. Petrol engine 2. Lithium ion (Li-ion) battery 3. DC/DC converter 4. 12-volt battery 5. Inverter, Electric motor for driving and Power generator | <ol style="list-style-type: none"> 6. Approaching Vehicle Sound for Pedestrians (VSP) system 7. Rear inverter and Rear electric motor for driving (4WD models) |
|--|--|

The NISSAN e-POWER system generates electric power by running the power generator with the petrol engine, and stores the generated electric power in the Lithium ion (Li-ion) battery or

provides it to the electric motor for driving directly. This vehicle can be driven by running the electric motor for driving with the electric power, which is stored or generated.

2 e-POWER SYSTEM OVERVIEW

ELECTRIC MOTORS

This vehicle has two types of electric motors.

- Electric motor for driving
- Power generator

The electric motor for driving generates traction power to drive the vehicle instead of the engine, using the electric power stored in the Lithium ion (Li-ion) battery or the generated electric power by the engine and power generator.

The power generator is powered by the petrol engine and generates electric power.

LITHIUM ION (Li-ion) BATTERY

The Lithium ion (Li-ion) battery is charged with the electric power generated by the power generator and/or the regenerative power from the electric motor for driving. While driving, the Li-ion battery provides the stored electric power to the electric motor for driving. Because the engine charges the Li-ion battery when the level of remaining charge in the Li-ion battery is low, the battery does not have to be charged from an outside source like an all-electric vehicle. If the vehicle is parked for a long period of time, the Li-ion battery discharges gradually. To avoid this occurrence, drive the vehicle for approximately 30 minutes at least once every two to three months. Otherwise, the Li-ion battery may be damaged. If the Li-ion battery is completely discharged and the e-POWER system cannot be activated, contact a NISSAN dealer or qualified workshop.

REGENERATIVE BRAKE

The regenerative brake is a function that can reduce the vehicle speed by using the electric motor instead of the engine braking for the petrol engine vehicle. The Lithium ion (Li-ion) battery can be charged by the generated electric power when the vehicle decelerates, saving electric power consumption and improving fuel efficiency.

NOTE:

The regenerative brake may provide less deceleration when the Li-ion battery is fully charged while driving on a long downhill road, when the outside temperature is low or when driving on a slippery road.

WHEN THE VEHICLE STARTS THE ENGINE

In the e-POWER system, the engine may run under the following conditions.

- When the Lithium ion (Li-ion) battery charge is low (to generate electric power)
- When depressing the accelerator pedal strongly (to generate electric power)
- When driving on a long downhill (to generate deceleration without using fuel)
- When the engine is cold (to warm up the engine)
- When opening the bonnet with the e-POWER system running (to avoid an accident when performing maintenance)
- When turning on the air conditioner
- When engine start is required by maintenance mode
- When the accelerator pedal is depressed while the vehicle is stationary and in the P (Park) position

NOTE:

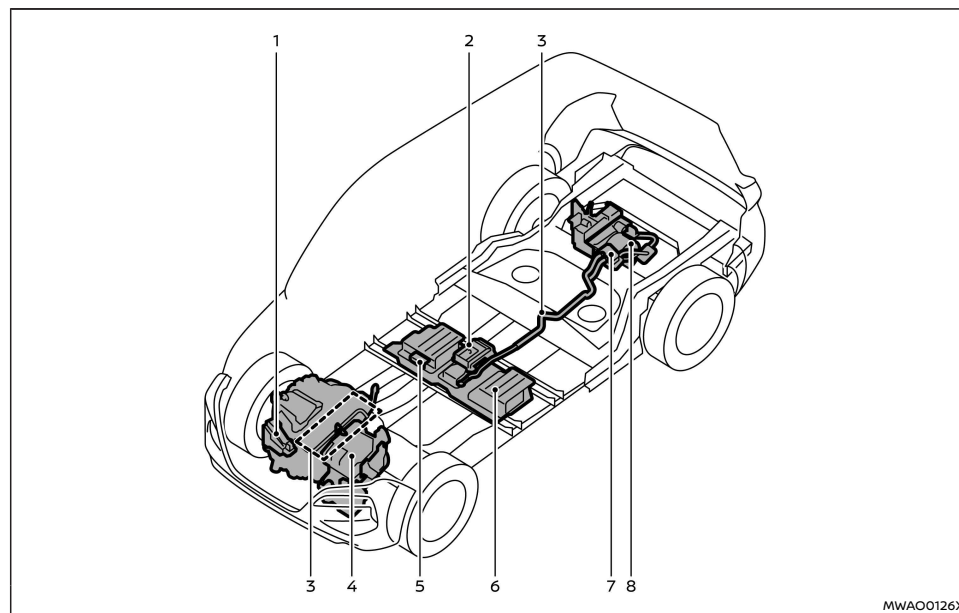
When the Li-ion battery is fully charged and regeneration is continued, the electric motor may start the engine to dissipate the excess electric power generated. In this mode the engine is not using fuel, and this will maintain vehicle control.

e-POWER SYSTEM PRECAUTIONS

HIGH VOLTAGE COMPONENTS

⚠ WARNING

- The e-POWER system uses high voltage up to approximately 420 volts. Obey the caution labels attached to the high voltage components.
- Never touch high voltage harnesses, their connectors or high voltage parts (electric motor for driving and Lithium ion (Li-ion) battery, etc.). Touching, disassembling, removing or replacing those parts and harnesses can cause severe burns or electric shock that may result in serious injury or death.



MWAO0126X

The e-POWER system consists of the following high voltage parts.

1. Air conditioner compressor

This compressor is for the air conditioner system in the passenger compartment.

2. DC/DC converter

This converter is for converting Li-ion battery power to 12-volt battery voltage.

3. High voltage harnesses (orange)

These harnesses are high voltage and orange-colored. Be sure not to touch the harnesses or remove the connector on the base of the cable.

4. Inverter, Electric motor for driving and Power generator

a. Inverter (2WD)/Front inverter (4WD)

This device controls various functions related to

the e-POWER system. Be careful because it can be hot after driving.

b. Power generator

This generator is for generating electric power. Be careful because it can be hot after driving.

c. Electric motor for driving (2WD)/Front electric motor for driving (4WD)

This motor is for running the vehicle. Be careful because it can be hot after driving.

5. Service plug

This plug is used to cut-off the high voltage when performing maintenance. Never touch this plug.

6. Lithium ion (Li-ion) battery

This battery is charged from the electric power generated by the power generator and/or the regenerative power from the electric motor for driving. The Li-ion battery also supplies the electric power to the electric motor for driving while driving.

7. High voltage junction box

This box is for distributing electric power to high voltage parts.

8. Rear inverter and Rear electric motor for driving (4WD)

a. Rear inverter

This device controls various functions related to the e-POWER system. Be careful because it can be hot after driving.

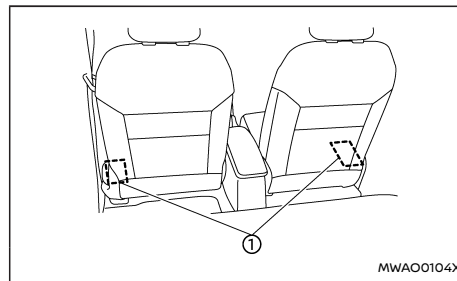
b. Rear electric motor for driving

This motor is for running the vehicle. Be careful because it can be hot after driving.

e-POWER SYSTEM CHARACTERISTICS

⚠ WARNING

Before leaving the vehicle, be sure to place the vehicle in the P (Park) position and place the power switch in the OFF position. Otherwise, the vehicle will creep and start abruptly if the accelerator pedal is depressed by mistake. This may cause serious injury or death.



The air inlets ① for cooling the Lithium ion (Li-ion) battery are located under the front seats.

CAUTION

- **Do not cover the air inlets. Otherwise it will reduce output performance of the e-POWER system or cause vehicle damage. Additionally, do not allow any liquid or sand to get in the air inlet.**
- **Do not spill water onto the Li-ion battery or load large amounts of water in open containers (aquariums or buckets) into**

the vehicle. If the water spills onto the Li-ion battery, it may cause a short circuit and damage the Li-ion battery.

- **Do not place any heavy objects under the front seats or stomp the floor around there, as the Li-ion battery is located under the front seats.**
- **If a large amount of liquid is spilled onto the Li-ion battery area, contact a NISSAN dealer or qualified workshop as soon as possible.**

Noise and vibration

After the e-POWER system is activated, the following noises and vibrations that are unique to the e-POWER system may occur. This does not indicate a malfunction.

- Electric motor noise from the engine compartment
- Noise and vibration when the engine starts or stops running
- Operating noise or electric motor noise when releasing the accelerator pedal or depressing the brake pedal
- Engine noise due to rapid acceleration
- Fan noise from under the floor
- Noise from the vehicle in order to alert pedestrians to the presence of an approaching vehicle. See "Approaching Vehicle Sound for Pedestrians (VSP) system" (P.12).

ROAD ACCIDENT CAUTIONS

NOTE:

Higher engine idling speed is set for this vehicle, compared to the one for a conventional petrol engine model. This is to charge the Li-ion battery with the engine during idling, and it is not a malfunction.

WARNING

In case of a collision or an accident, be sure to observe the following warnings.

- Pull your vehicle off the road, place the vehicle in the P (Park) position, apply the parking brake and turn the e-POWER system off.
- Never touch the high voltage parts or harnesses if they are exposed. For the locations of the high voltage parts and harnesses, see "High voltage components" (P.5).
- Inspect the ground under the vehicle. If you noticed liquid spilled from the Lithium ion (Li-ion) battery, contact a NISSAN dealer or qualified workshop or emergency services as soon as possible. Ignoring such conditions may lead to a fire.
- Never touch the liquid leaked on interior surfaces or outside the vehicle. If the liquid spilled from the Li-ion battery comes into contact with skin or clothes, immediately flush the area with plenty of clean water and see a doctor.
- If the vehicle receives a strong impact to the floor while driving, stop the vehicle in a safe location and check the floor. If the floor is damaged, never touch it and contact a NISSAN dealer or qualified workshop as soon as possible.
- If a fire occurs in the Li-ion battery or high voltage parts, leave the vehicle as soon as possible. When extinguishing the fire, use a

type ABC, BC or C fire extinguisher that is meant for use on electrical fires. Water can be used only when a large amount of water from a fire hydrant is available. Never attempt to extinguish a fire in an inappropriate way, as this can be dangerous.

- When towing your vehicle, lift the front wheels or all four wheels. If the vehicle is towed with front wheels on the ground, the electric motor for driving may generate electric power and cause damage to the vehicle.
- If you are not able to safely assess the vehicle due to vehicle damage, do not touch the vehicle. Leave the vehicle and contact a NISSAN dealer or qualified workshop or emergency services. Advise 1st responders that this is a vehicle equipped with e-POWER system.
- In the event of an accident that requires body repair and painting, contact a NISSAN dealer or qualified workshop.

When the vehicle body is largely damaged or deformed, electrical leakage or shock depending on the damage condition could occur. Never touch the high voltage parts, such as Li-ion battery, and the orange-colored harnesses connected to them.

- Do not drive the vehicle with any exterior lights damaged. If water has leaked inside the light, it may lead to fumes or a fire.

EMERGENCY SHUT-OFF SYSTEM

NOTE:

If the vehicle collides or a malfunction of the e-POWER system occurs, the READY to drive indicator light may be turned off since the high voltage system has been turned off. This is designed to minimise the risk of injury and accidents and is not a malfunction.

The emergency shut-off system is activated and the high-voltage system automatically turns off in the following conditions:

- Front and side collisions in which the supplemental air bags are deployed.
- Certain rear collisions.
- Certain e-POWER system malfunctions.

For the above collisions and the certain e-POWER system malfunctions, the READY to drive indicator light will turn off. See "Warning lights, indicator lights and audible reminders" (P.83).

The emergency shut-off system activates for the above collisions to minimise risk of an event that could cause an injury or an accident. If the emergency shut-off system activates, the power switch may not switch to the READY to drive position. If this occurs, contact a NISSAN dealer or qualified workshop. Even if the power switch is switched to the READY to drive position, the system may shut-off suddenly. Therefore, drive cautiously to the nearest NISSAN dealer or qualified workshop or contact a NISSAN dealer or qualified workshop as soon as possible.

EFFICIENT USE OF YOUR VEHICLE

The fuel consumption varies considerably depending upon road conditions, weather, temperature, and number of occupants, etc. Keeping the following points in mind and reducing electric power consumption will help improve the fuel efficiency.

BEFORE DRIVING

- Plan for the route with less power consumption by the vehicle. Driving on uphill roads increases electric power consumption. If you choose the route where there are few uphill roads, the vehicle can reduce electric power consumption.
- Do not leave unnecessary cargo loaded. Removing unnecessary cargo from the vehicle to reduce vehicle weight can reduce electric power consumption.
- Keep the tyres inflated to the correct pressure. Low tyre pressure increases electric power consumption.

WHEN DRIVING

- Drive your vehicle with smooth start and acceleration.
 - Abrupt starting and acceleration will consume more electric power and decrease fuel economy.
 - You can accelerate the vehicle with less power consumption by checking the condition of the electric power consumption in the power meter.
- Keep a distance from the vehicle in front of you. Do not decelerate the vehicle more than necessary so that you can decrease the

e-Pedal STEP

electric power consumption to accelerate again.

- Do not drive at excessive speeds on a highway. Driving at excessive speeds consumes electric power more than necessary.
- Set the air conditioner at a moderate temperature and turn it off if unnecessary. Redundant power consumption can be reduced by the air conditioner.
- Do not use the defogger more than necessary. After removing fog from the windscreen, switching to the other air flow mode reduces the engine operation frequency and improve the fuel economy.
- Drive the vehicle in ECO mode. Doing so makes the driving force response gentler than in STANDARD mode, it suppresses unnecessary acceleration/deceleration and realises energy saving. The torque split ratio of rear motor is controlled for optimal fuel economy. (The ratio is changed due to road surface condition.) (4WD models)
- When the ECO Mode Customise (Air Conditioning) is turned ON (fuel efficiency- oriented), the fuel efficiency is improved by reducing the performance of the air conditioner.

NOTE:

The following are some conditions in which the fuel economy decreases significantly:

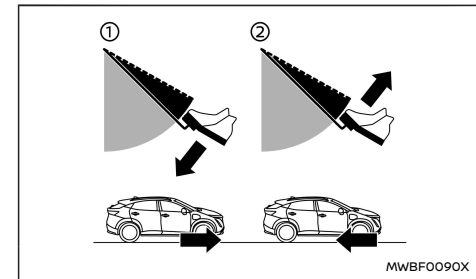
- When driving on a route where there are many uphill roads.

- When continuing driving at a high speed on a highway.
- When starting, accelerating or braking abruptly.

⚠ WARNING

Never rely solely on the e-Pedal Step system, as there is a performance limit to the system function. Always drive carefully and attentively. The brake pedal should be operated depending on traffic or road conditions.

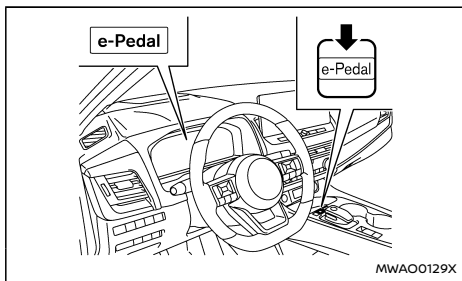
The e-Pedal Step system enables the driver to slow the vehicle by operating only the accelerator pedal. This system helps to keep the driver from moving his/her foot between the accelerator pedal and the brake pedal.



- ① Acceleration
- ② Deceleration (instead of brake pedal)

e-Pedal STEP SYSTEM OPERATION

When the e-Pedal Step system is activated, the regenerative brake is enhanced and the driver can adjust the vehicle speed by only depressing or returning the accelerator pedal. When you release (take your foot off) the accelerator pedal, the vehicle slows down smoothly without depressing the brake pedal.



The e-Pedal Step system will be turned ON or OFF each time the <e-Pedal> switch (located on the centre console) is operated. (The e-Pedal indicator in the vehicle information display shows the status of the e-Pedal Step system.)

When the e-Pedal Step system is activated, the characteristics of the accelerator pedal change significantly and the accelerator pedal operates differently than a conventional accelerator pedal operates. Be sure to confirm the status of the e-Pedal Step system (ON or OFF) in the vehicle information display before driving.

When the e-Pedal Step system is activated, the e-

Pedal indicator changes to blue and displays [e-Pedal]. When the e-Pedal Step system is turned off, the indicator changes to grey and displays [e-Pedal OFF].

System activation

To activate the e-Pedal Step system, place the power switch in the READY to drive or ON position and operate the <e-Pedal> switch. Be sure to confirm the status of the e-Pedal Step system.

System deactivation

To deactivate the e-Pedal Step system, with the power switch in the READY to drive or ON position, push the <e-Pedal> switch.

NOTE:

- **When the e-Pedal Step system is switched to ON or OFF, the degree of vehicle deceleration will change.**
- **The e-Pedal Step system is automatically turned OFF when the e-POWER system is restarted.**

e-Pedal Step driving features

The e-Pedal Step system provides the following driving features:

When driving the vehicle:

- Depressing or returning the accelerator pedal will change the degree of acceleration and deceleration accordingly.
- Returning the accelerator pedal generates more deceleration than normal. (The maxi-

mum deceleration changes according to the vehicle speed.)

- Releasing (taking your foot off) the accelerator pedal reduces the vehicle speed. To stop the vehicle, depress the brake pedal.
- The vehicle's brake lights illuminate when the deceleration level reaches an ordinary braking operation.
- If the e-Pedal Step system does not decelerate the vehicle sufficiently, depress the brake pedal whenever necessary.

The brake pedal can be operated to reduce the vehicle speed in the same way as normal even when the e-Pedal Step system is activated.

When reversing the vehicle:

With the shift position in the R (Reverse), the accelerator pedal can be used in the same way as in the e-Pedal Step system is off.

Other driving tips for the e-Pedal Step system:

- For smooth deceleration when the e-Pedal Step system is activated, it is recommended to adjust the accelerator pedal while driving with your foot on it (depressing or returning, but not releasing).
- Shifting the shift position from D (Drive) to B or from B to D will not affect the e-Pedal Step system feature.
- The e-Pedal Step system will not function under the following conditions:
 - When the vehicle is placed in the P (Park) or N (Neutral) position.

- e-Pedal Step system does not work when a driving support function such as ProPILOT (where fitted) is operating.
- Brake pedal may move depending on deceleration and you may feel a noise when e-Pedal Step is active. This is a normal system operation.

e-Pedal STEP SYSTEM LIMITATIONS

⚠ WARNING

Listed below are the system limitations for the e-Pedal Step system. Failure to operate the vehicle in accordance with these system limitations could result in serious injury or death.

- **If the deceleration force provided by the e-Pedal Step system is not sufficient, depress the brake pedal.**
- **Under the following conditions the e-Pedal Step system may not decelerate the vehicle sufficiently. Depress the brake pedal whenever necessary.**
 - When excessively heavy baggage is loaded in the vehicle.
 - When driving on steep downhill roads.
 - When driving on icy roads.
- **Do not use the e-Pedal Step system when your vehicle is towed.**

CAUTION

- **The characteristics of deceleration changes according to the vehicle speed. At very low speeds, the vehicle "creeps",**

similar to the e-Pedal Step system is deactivated.

- **Be careful not to operate the <e-Pedal> switch mistakenly or unintentionally.**
- **Frequent braking may result in overheating the brakes. This can be dangerous.**
- **Apply the regenerative brake depending on a slope under steep downhill driving.**

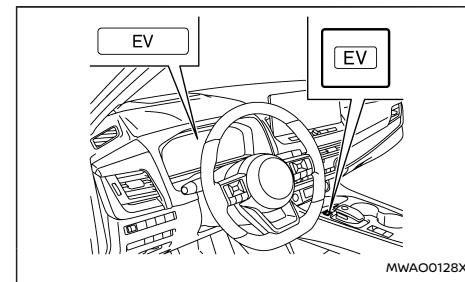
e-Pedal STEP SYSTEM MALFUNCTION

If the e-Pedal Step system malfunctions, [e-Pedal system failure! Press brake pedal to slow or stop] warning message appears on the vehicle information display. When the warning message appears, the e-Pedal Step system will be turned off automatically. Have the system checked as soon as possible by a NISSAN dealer or qualified workshop.

EV MODE

When EV mode is selected, you can drive the vehicle with the chance of engine starting reduced as much as possible. This mode is used when you wish to drive the vehicle quietly on a road such as a residential street in an early morning or a late at night, since the vehicle is powered by the Lithium ion (Li-ion) battery.

How to use the EV mode:



- When the READY to drive indicator light illuminates, EV mode can be turned on or off by pushing the EV mode switch.
- When EV mode is on, the EV mode indicator illuminates in the vehicle information display.
- When the outside temperature is low, the engine may start. However, when the EV mode is turned on before the engine starts, the vehicle can be driven by only the Li-ion battery due to reduction of the engine starting.

APPROACHING VEHICLE SOUND FOR PEDESTRIANS (VSP) SYSTEM

NOTE:


- If the system malfunction occurs, EV mode is automatically turned off.
- If the accelerator pedal is depressed when the shift position is in the P (Park) position, the engine starts and EV mode is turned off.
- If the Li-ion battery is fully charged by the regenerative braking on a long downhill road, EV mode is turned off to protect the Li-ion battery.
- When the accelerator pedal is depressed to the floor on an uphill road or by abrupt acceleration, the engine starts and EV mode is turned off.
- If the bonnet is opened when the READY to drive indicator light illuminates, the engine starts automatically and EV mode is turned off.
- When the front defogger switch is turned on, the engine starts due to a warm-up operation, and EV mode cannot be used or it is turned off.
- If the system judged that the forced charging is necessary, EV mode is turned off and the engine starts.
- If the system judged that the warm-up operation is necessary, EV mode is turned off and the engine starts.
- When the outside temperature is low, EV mode may not be used.
- When the Li-ion battery charge is low, EV mode may not be used or is turned off.

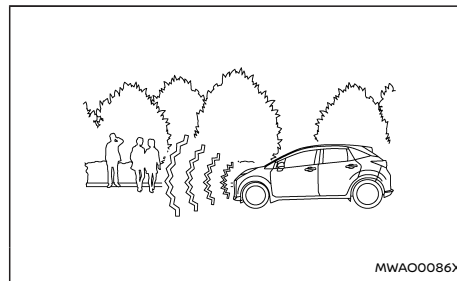
The Approaching Vehicle Sound for Pedestrians (VSP) system is a function that uses sound to help alert pedestrians of the presence of the vehicle when it is being driven at a low speed.

The VSP sounds when the READY to drive indicator light is illuminated under the following conditions:

- When the vehicle speed is within 30 km/h (19 MPH) when starting.
- When the vehicle speed is less than 25 km/h (16 MPH) while decelerating.
- When the shift position is in the R (Reverse) position.

The sound stops when the vehicle stops.

If the system malfunction occurs, the VSP warning light  in the meter illuminates. If the VSP warning light illuminates, have the VSP system checked by a NISSAN dealer or qualified workshop immediately.



WARNING

If the sound from the VSP system is not heard while driving, stop the vehicle in a safe and quiet location. Open a window, and then place the vehicle in the R (Reverse) position with the brake pedal firmly depressed. Check that the operating sound can be heard from the front side of the vehicle. If the sound from the VSP system is not heard, contact a NISSAN dealer or qualified workshop.

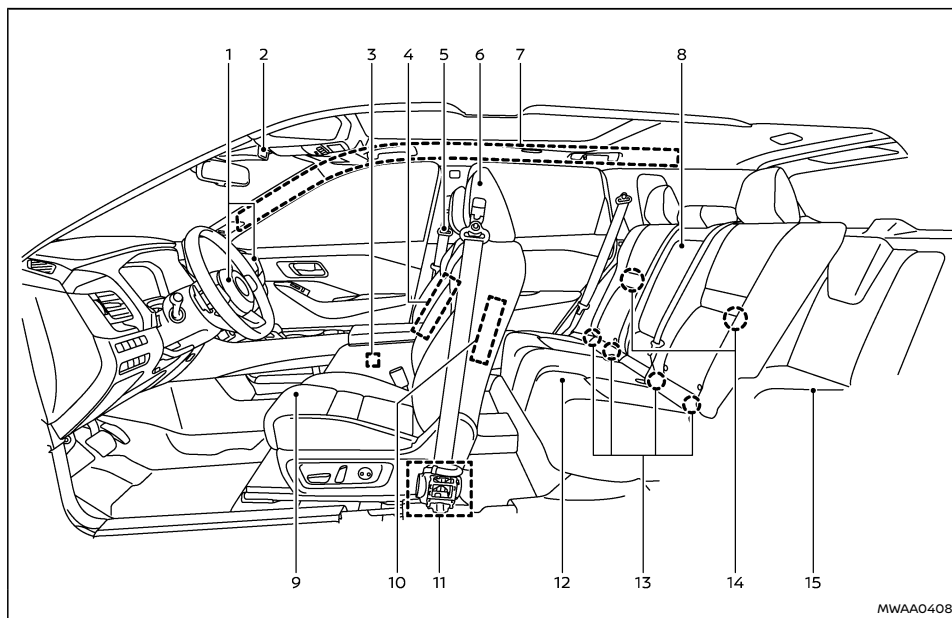
NOTE:

- The VSP also sounds when all of the following conditions are met, in order to remind you to place the power switch in the OFF position.
 - When the shift position is in the P (Park) position.
 - When the READY to drive indicator light illuminates.
 - When the driver's seat belt is not fastened.
 - When any door (except the back door) is opened.
- If you wish to increase the volume of the VSP system, contact a NISSAN dealer or qualified workshop. (It is not possible to lower the volume.)

0 Illustrated table of contents

Seats, seat belts and Supplemental Restraint System (SRS)	14	Instrument panel	21
Exterior front	15	Left-Hand Drive (LHD) model	21
Exterior rear	16	Right-Hand Drive (RHD) model	22
Passenger compartment	17	Meters and gauges	23
Cockpit	18	Models with full-screen display	23
Left-Hand Drive (LHD) model	18	Engine compartment	24
Right-Hand Drive (RHD) model	19	KR15DDT engine model	24

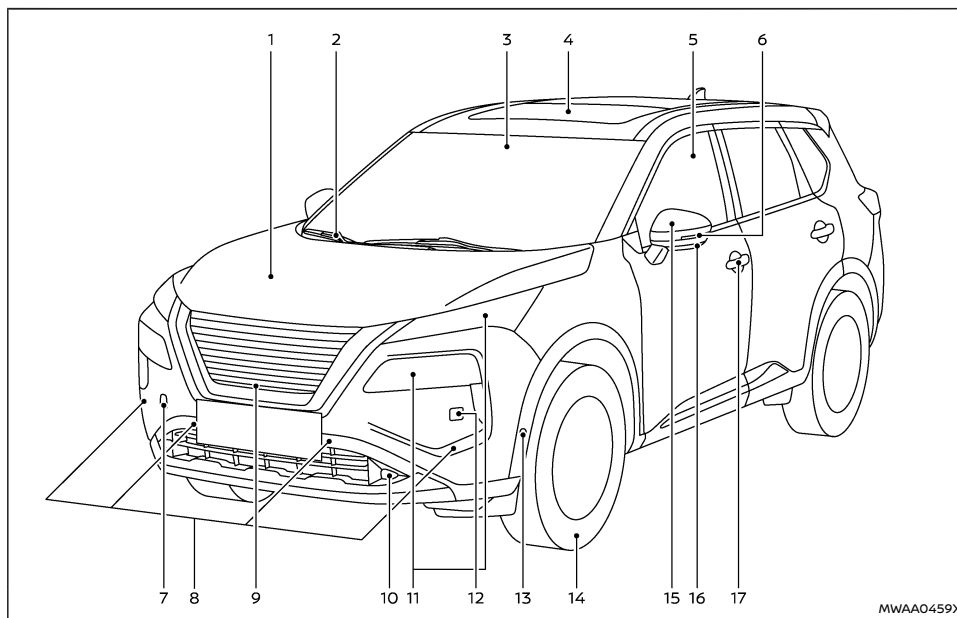
SEATS, SEAT BELTS AND SUPPLEMENTAL RESTRAINT SYSTEM (SRS)



10. Supplemental side-impact air bags (P.57)
 11. Pre-tensioner seat belts (P.68)
 12. Second row seats (P.30)
 - Child restraints (P.43)
 13. ISOFIX child restraint system (for second row seats) (P.49)
 14. Child restraint anchor points (for top tether strap) (P.50)
 15. Third row seats* (P.33)
- *: where fitted

- | | |
|---|---|
| 1. Supplemental front-impact air bags (P.57) | 5. Seat belts (P.38) |
| 2. Front passenger air bag status light* (P.63) | 6. Head restraints (P.35) |
| 3. Occupant classification sensor (front passenger seat) (P.62) | 7. Supplemental curtain side-impact air bags (P.57) |
| 4. Front central side-impact supplemental air bag (P.57) | 8. Second row seat armrest (P.34) |
| | 9. Front seats (P.26) |

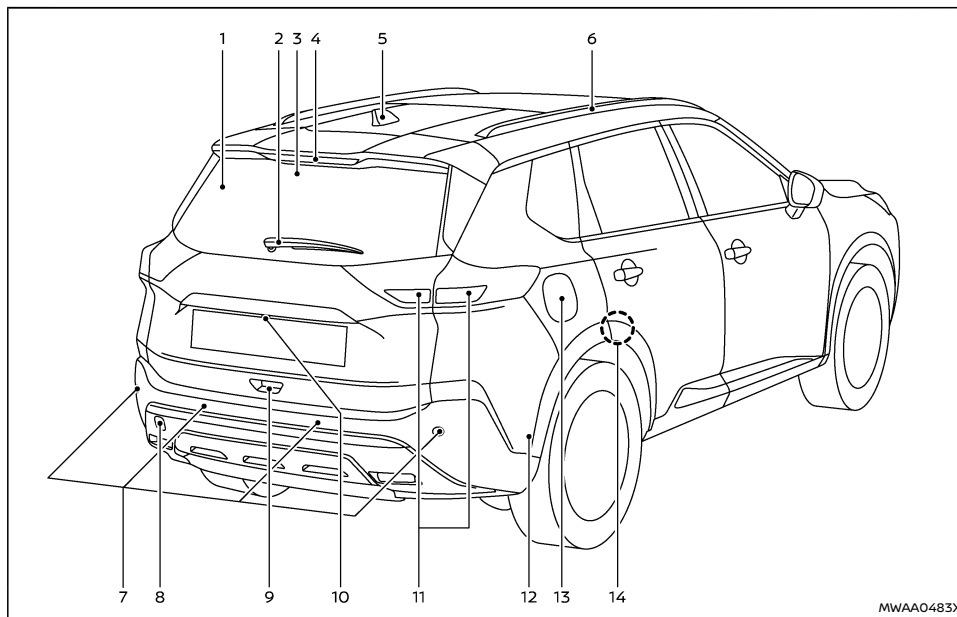
EXTERIOR FRONT



- | | |
|---|--|
| 1. Bonnet (P.173) | 4. Sunroof* (P.148) |
| 2. Windscreen wiper and washer
– Switch operation (P.129)
– Window washer fluid (P.437) | 5. Power windows (P.146) |
| 3. Front camera* (P.121, P.122, P.257, P.263, P.276, P.309, P.338) | 6. Side turn signal lights (P.128) |
| | 7. Recovery hook (P.412) |
| | 8. Parking sensors (centre and corner)*
– Parking sensor (sonar) system (P.377)
– ProPILOT Park* (P.381) |

- | |
|--|
| 9. Front view camera* (P.207) |
| 10. Fog lights* (P.128) |
| 11. Headlights and turn signal lights (P.120) |
| 12. Headlight cleaner* (P.130) |
| 13. Parking sensors (side)*
– Parking sensor (sonar) system (P.377)
– ProPILOT Park* (P.381) |
| 14. Tyres
– Wheels and tyres (P.447, P.460)
– Emergency tyre puncture repair kit (P.403)
– Tyre Pressure Monitoring System (TPMS) (P.87, P.231) |
| 15. Outside rearview mirrors (P.186) |
| 16. Side view camera* (P.207) |
| 17. Doors
– Keys (P.156)
– Door locks (P.157)
– Intelligent Key system (P.160)
– Security system (P.171) |
| *: where fitted |

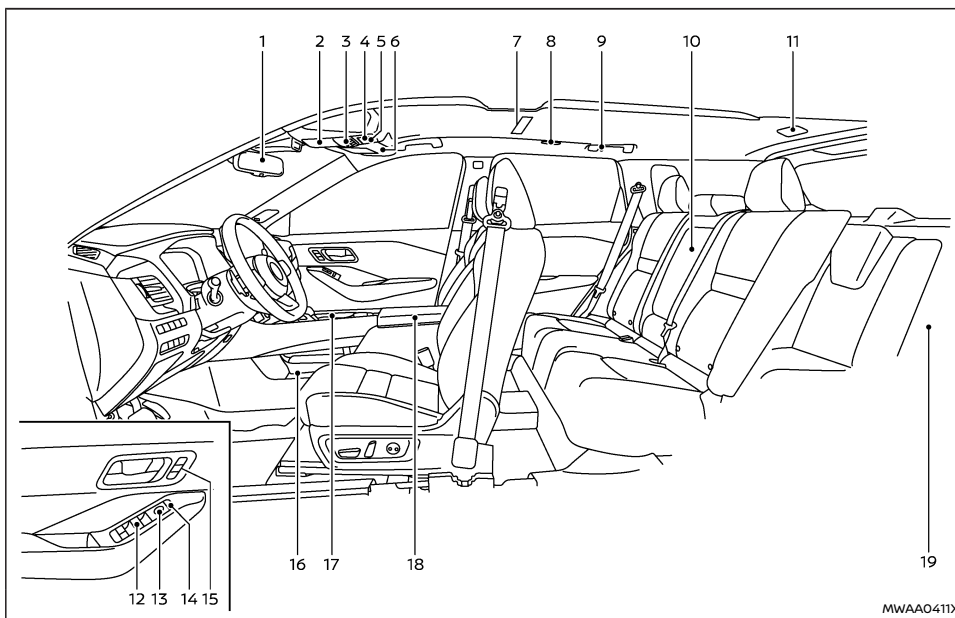
EXTERIOR REAR



- | | |
|--|---|
| 1. Rear window defogger (P.132) | 5. Antenna (P.223) |
| 2. Rear window wiper and washer
– Switch operation (P.130)
– Window washer fluid (P.437) | 6. Roof rack* (P.145) |
| 3. Intelligent Rear View Mirror camera (P.181) | 7. Parking sensors (centre and corner)*
– Parking sensor (sonar) system (P.377)
– Rear Automatic Braking (RAB)* (P.358)
– ProPILOT Park* (P.381) |
| 4. High-mounted brake light (P.443) | |

- | |
|---|
| 8. Recovery hook (P.412) |
| 9. Back door (P.174)
– Intelligent Key system* (P.160) |
| 10. Rear view camera* (P.201, P.207) |
| 11. Rear combination lights (P.443)
– Rear fog light (P.129) |
| 12. Parking sensors (side)*
– Parking sensor (sonar) system (P.377)
– ProPILOT Park* (P.381)
– Rear Automatic Braking (RAB)* (P.358) |
| 13. Fuel-filler lid (P.178)
– Fuel information (P.457) |
| 14. Child safety rear door locks (P.159) |
| *: where fitted |

PASSENGER COMPARTMENT



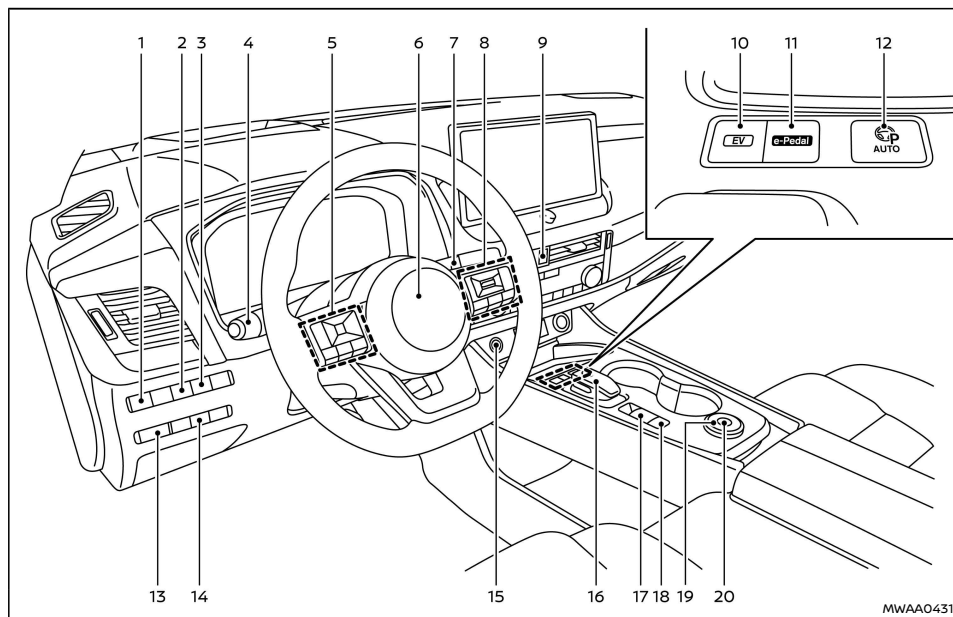
- | | |
|---|--|
| 1. Inside rearview mirror (P.181)
– Intelligent Rear View Mirror (P.181) | 6. Sun visors (P.150) |
| 2. Sunglasses holder (P.141) | 7. Room light* (P.152) |
| 3. Map lights (P.151) | 8. Rear personal lights* (P.152) |
| 4. Sunroof switch* (P.148) | 9. Assist grips (P.151) / Coat hooks (P.142) |
| 5. SOS button* (P.137) | 10. Rear cup holders (P.139) |
| | 11. Cargo light (P.152) |

- | |
|--|
| 12. Power window switches (P.146) |
| 13. Outside rearview mirror control switches (driver's side) (P.186) |
| 14. Power door lock switches (P.158) |
| 15. Memory switches* (driver's and front passenger's side*) (P.187) |
| 16. Lower console tray (P.141) |
| 17. Front cup holders (P.139) |
| 18. Console box (P.141)
– USB (Universal Serial Bus) charging connector (back side)* (P.135)
– Heated second row seat switches (back side)* (P.32)
– Rear temperature control (back side)* (P.222) |
| 19. Cargo area
– Adjustable luggage floor* (P.143)
– Luggage hooks (P.142)
– Tonneau cover (P.142)
– Emergency tyre puncture repair kit (P.403)
– 12-volt battery (P.437)
– Power outlet (P.134) |

*: where fitted

COCKPIT

LEFT-HAND DRIVE (LHD) MODEL

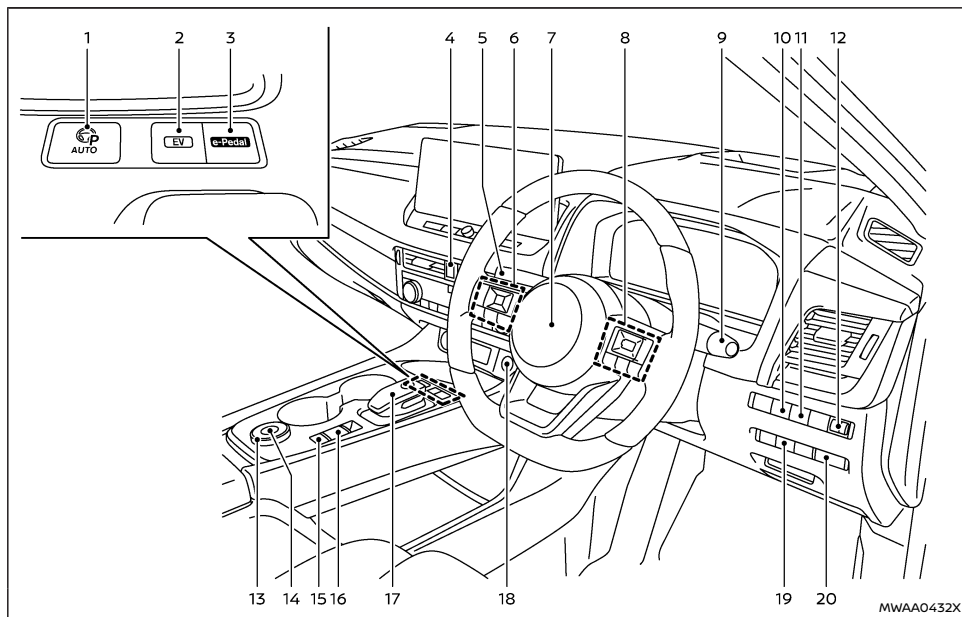


1. Headlight aiming control switch* (P.125)
2. Steering Assist switch* (models with ProPILOT Assist system) (P.309) or dynamic driver assistance switch* (models without ProPILOT Assist system) (P.276)
3. Head Up Display (HUD) switch* (P.118)
4. Headlight and turn signal switch (P.120)/Fog light switch (P.128)
5. Steering-wheel-mounted controls (left side)
 - Audio control**
 - Vehicle information display control (P.92)

6. Steering wheel (P.180)
 - Horn (P.132)
 7. Wiper and washer switch (P.129)
 8. Steering-wheel-mounted controls (right side)
 - Speed limiter switches* (P.289)
 - Cruise control switches* (P.291)
 - Intelligent Cruise Control (ICC) switches* (P.293)
 - ProPILOT Assist switches* (P.309, P.276)
 - Bluetooth® Hands-Free Phone System switches**
 - Voice Recognition system switch**
 9. Hazard indicator flasher switch (P.402)
 10. EV mode switch (P.11)
 11. e-Pedal switch (P.9)
 12. ProPILOT Park switch* (P.381)
 13. Instrument brightness control (P.81)
 14. Power back door switch* (P.174)
 15. Push-button power switch (P.235)
 16. Shift lever (P.240)
 - P position switch (P.240)
 17. Parking brake switch (P.189)
 18. Automatic brake hold switch (P.191)
 19. Drive Mode Selector*** (P.238)
 20. Hill descent control switch* (P.375)
- *: where fitted
 **: See the separate NissanConnect Owner's Manual (where fitted).

***: The Drive Mode Selector illustrated is for the 4WD model. On the 2WD model, the shape and location differ.

RIGHT-HAND DRIVE (RHD) MODEL



1. ProPILOT Park switch* (P.381)

2. EV mode switch (P.11)

3. e-Pedal switch (P.9)

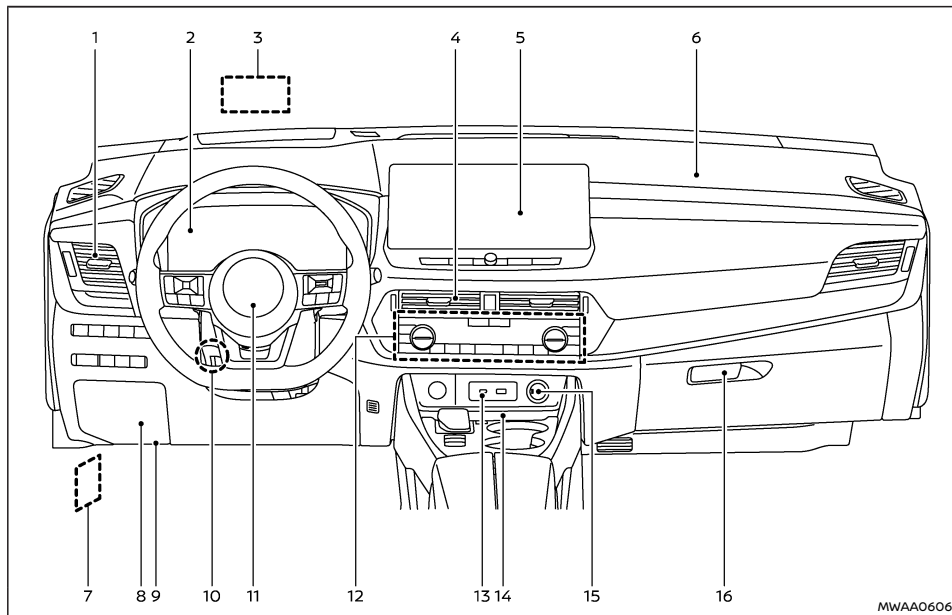
4. Hazard indicator flasher switch (P.402)

5. Headlight and turn signal switch (P.120)/Fog light switch (P.128)
6. Steering-wheel-mounted controls (left side)
 - Audio control**
 - Vehicle information display control (P.92)
7. Steering wheel (P.180)
 - Horn (P.132)
8. Steering-wheel-mounted controls (right side)
 - Speed limiter switches* (P.289)
 - Cruise control switches* (P.291)
 - Intelligent Cruise Control (ICC) switches* (P.293)
 - ProPILOT Assist switches* (P.309, P.276)
 - Bluetooth® Hands-Free Phone System switches**
 - Voice Recognition system switch**
9. Wiper and washer switch (P.129)
10. Head Up Display (HUD) switch* (P.118)
11. Steering Assist switch* (models with ProPILOT Assist system) (P.309) or dynamic driver assistance switch* (models without ProPILOT Assist system) (P.276)
12. Headlight aiming control switch* (P.125)
13. Drive Mode Selector*** (P.238)
14. Hill descent control switch* (P.375)
15. Automatic brake hold switch (P.191)
16. Parking brake switch (P.189)
17. Shift lever (P.240)
 - P position switch (P.240)

18. Push-button power switch (P.235)
 19. Power back door switch* (P.174)
 20. Instrument brightness control (P.81)
- *: where fitted
- ** : See the separate NissanConnect Owner's Manual (where fitted).
- ***: The Drive Mode Selector illustrated is for the 4WD model. On the 2WD model, the shape and location differ.

INSTRUMENT PANEL

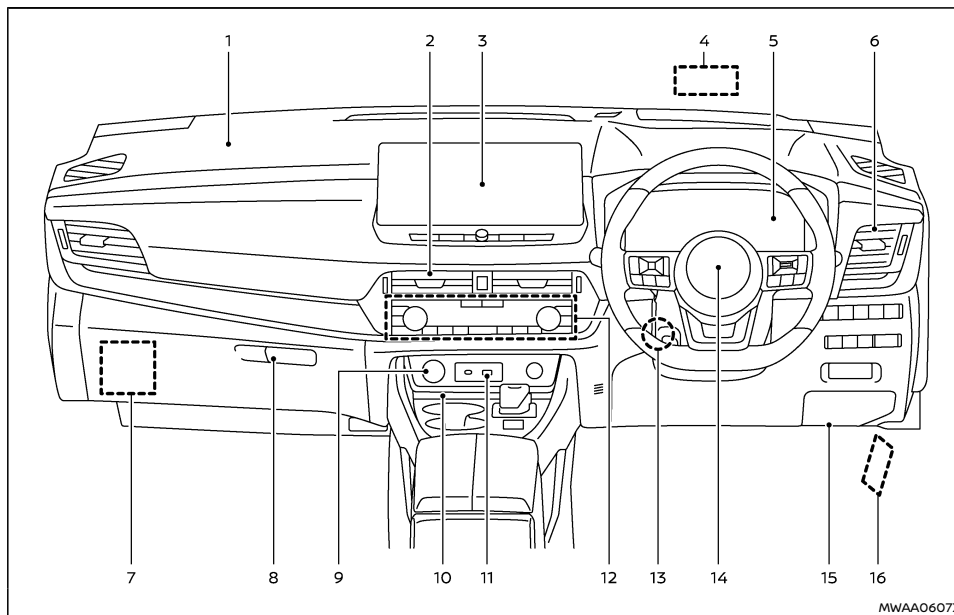
LEFT-HAND DRIVE (LHD) MODEL



- | | |
|--|---|
| <ol style="list-style-type: none"> 1. Side vent (P.219) 2. Meters and gauges (P.78)/Clock (P.117) 3. Head Up Display (HUD)* (P.118) 4. Centre vent (P.219) | <ol style="list-style-type: none"> 5. Audio system** or navigation system** <ul style="list-style-type: none"> – Rear view monitor* (P.201) – Intelligent Around View Monitor* (P.207) – Bluetooth® Hands-Free Phone System** – Clock** |
|--|---|

6. Front passenger supplemental air bag (P.57)
 7. Bonnet release handle (P.173)
 8. Fuse box cover (P.441)
 9. USB port for TSR map update*** (P.262)
 10. Tilt and telescopic steering lock lever (P.180)
 11. Driver supplemental front-impact air bag (P.57)
 12. Heater and air conditioner control (P.220)
 - Defogger switch (P.132)
 - Heated seat switches* (P.29)
 - Heated steering wheel switch* (P.133)
 - Heated windscreen* (P.131)
 13. USB (Universal Serial Bus) connection port(s)**
 14. Wireless charger* (P.135)
 15. Power outlet (P.134)
 16. Glove box (P.140)
- *: where fitted
- ** : See the separate NissanConnect Owner's Manual (where fitted)
- ***: Not functional depending on the country (where fitted)

RIGHT-HAND DRIVE (RHD) MODEL



MWA0607X

- | | |
|--|---|
| 1. Front passenger supplemental air bag (P.57) | — Clock** |
| 2. Centre vent (P.219) | 4. Head Up Display (HUD)* (P.118) |
| 3. Audio system** or navigation system** | 5. Meters and gauges (P.78)/Clock (P.117) |
| — Rear view monitor* (P.201) | 6. Side vent (P.219) |
| — Intelligent Around View Monitor* (P.207) | |
| — Bluetooth® Hands-Free Phone System** | |

7. Fuse box cover (P.441)
8. Glove box (P.140)
9. Power outlet (P.134)
10. Wireless charger* (P.135)
11. USB (Universal Serial Bus) connection port(s)**
12. Heater and air conditioner control (P.220)
 - Defogger switch (P.132)
 - Heated seat switches* (P.29)
 - Heated steering wheel switch* (P.133)
 - Heated windscreen* (P.131)
13. Tilt and telescopic steering lock lever (P.180)
14. Driver supplemental front-impact air bag (P.57)
15. USB port for TSR map update*** (P.262)
16. Bonnet release handle (P.173)

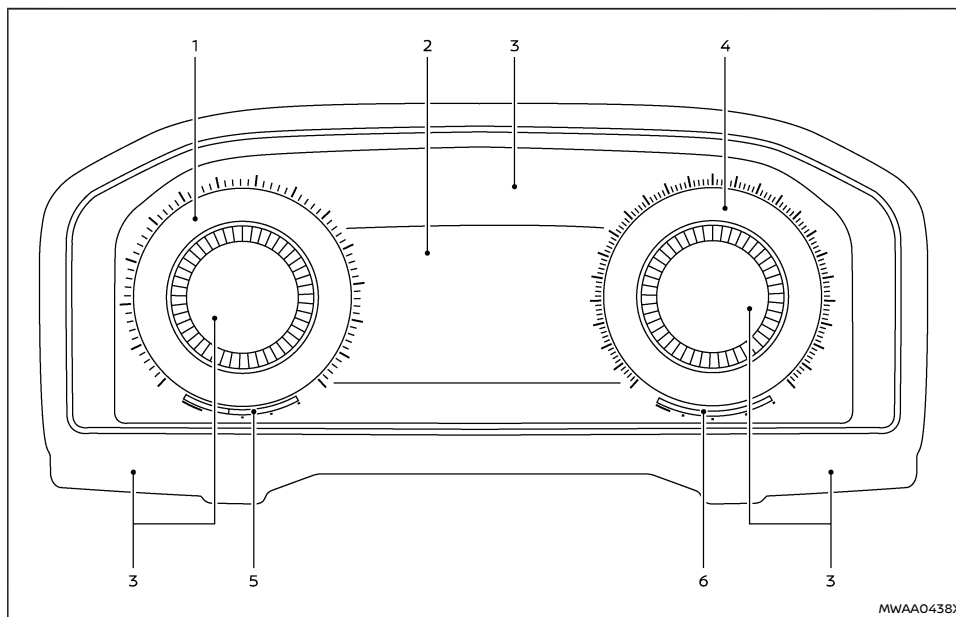
*: where fitted

**: See the separate NissanConnect Owner's Manual (where fitted).

***: Not functional depending on the country (where fitted)

METERS AND GAUGES

MODELS WITH FULL-SCREEN DISPLAY



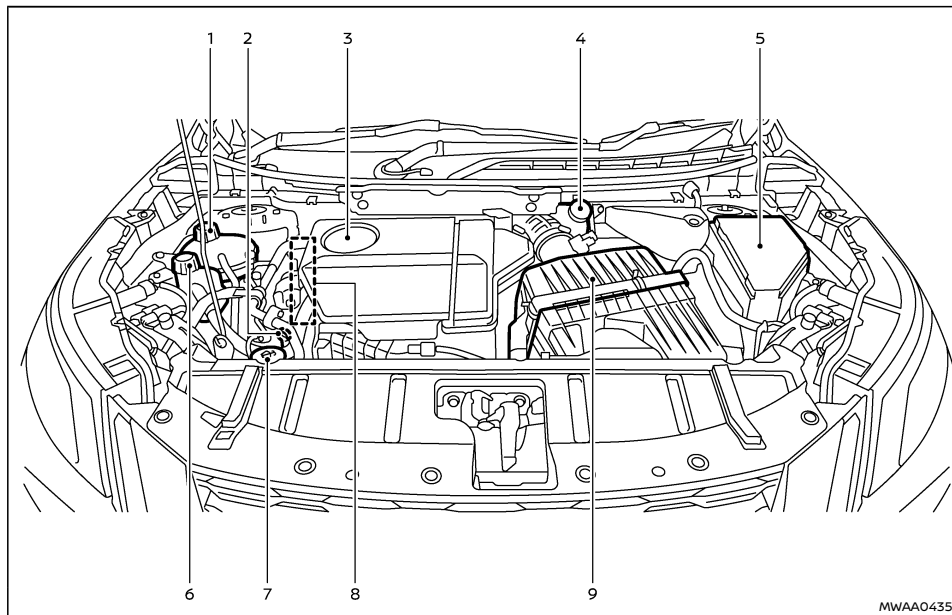
- | | |
|---------------------------------------|---|
| 1. Power meter (P.80) | 4. Speedometer (P.79) |
| 2. Vehicle information display (P.92) | 5. Li-ion battery available charge gauge (P.80) |
| — Odometer (P.79) | 6. Fuel gauge (P.81) |

3. Warning and indicator lights (P.83)

The view of the meter screen can be changed. (See “Changing the meter screen view (models with full-screen display)” (P.92).)

ENGINE COMPARTMENT

KR15DDT ENGINE MODEL



- | | |
|-------------------------------------|--|
| 1. Engine coolant reservoir (P.428) | 5. Fuse/fusible link box (P.440) |
| 2. Engine oil dipstick (P.430) | 6. Inverter coolant reservoir (P.429) |
| 3. Engine oil filler cap (P.430) | 7. Window washer fluid reservoir (P.437) |
| 4. Brake fluid reservoir* (P.434) | 8. Drive belt (P.432) |

9. Air cleaner (P.435)

*: The layout illustrated is for the Left-Hand Drive (LHD) models. On the Right-Hand Drive (RHD) models, the brake fluid reservoir is located on the opposite side.

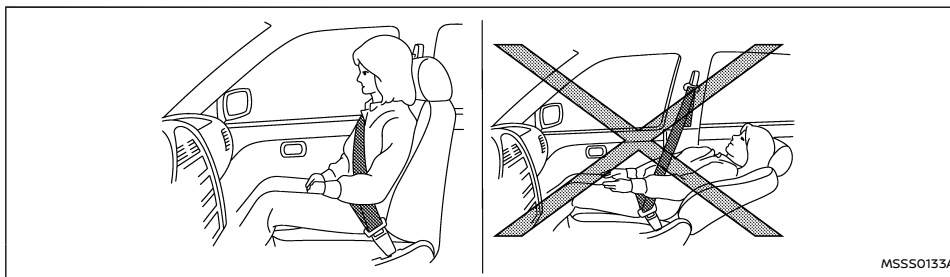
NOTE:

Your vehicle may not be equipped with an engine cover.

1 Safety — seats, seat belts and supplemental restraint system

Seats	26	Seat belt maintenance	42
Front seats	26	Child restraints	43
Second row seats	30	Precautions on child restraint usage	43
Third row seats (where fitted)	33	Universal child restraints for front seat and rear seats	44
Armrest	34	ISOFIX child restraint system (for second row seats)	49
Head restraints	35	Child restraint anchorage (for second row seats)	50
Adjustable head restraint components	35	Child restraint installation using ISOFIX (for second row seats)	50
Non-adjustable head restraint components	35	Child restraint installation using three-point type seat belt	52
Remove	35	Supplemental Restraint System (SRS)	57
Install	36	Precautions on Supplemental Restraint System (SRS)	57
Adjust	36	Supplemental air bag systems	62
Seat belts	38	Pre-tensioner seat belt system	68
Precautions on seat belt usage	38	Repair and replacement procedure	68
Child safety	40		
Pregnant women	40		
Injured persons	40		
Centre mark on seat belts	40		
Three-point type seat belts	41		

SEATS



⚠ WARNING

- Do not drive and/or ride in the vehicle with the seatback reclined. This can be dangerous. The shoulder belt will not be properly against the body. In an accident, you and your passengers could be thrown into the shoulder belt and receive neck or other serious injuries. You and your passengers could also slide under the lap belt and receive serious injuries.
- For the most effective protection while the vehicle is in motion, the seatback should be upright. Always sit well back and upright in the seat and adjust the seat properly. (See "Seat belts" (P.38).)
- Do not leave children unattended inside the vehicle. They could unknowingly activate switches or controls. Unattended children could become involved in serious accidents.
- To help avoid risk of injury or death

through unintended operation of the vehicle and/or its systems, do not leave children, people who require the assistance of others or pets unattended in your vehicle. Additionally, the temperature inside a closed vehicle on a warm day can quickly become high enough to cause a significant risk of injury or death to people and pets.

CAUTION

When adjusting the seat positions, be sure not to contact any moving parts to avoid possible injuries and/or damages.

FRONT SEATS

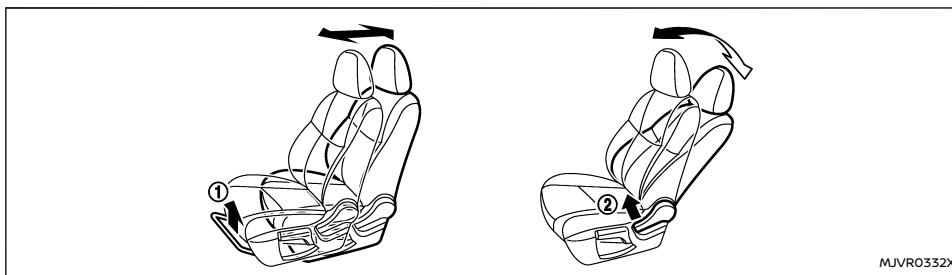
⚠ WARNING

Do not adjust the driver's seat while driving so that full attention may be given to vehicle operation.

Manual seat adjustment

⚠ WARNING

After adjusting a seat, gently shake the seat to confirm that the seat is locked securely. If the seat is not locked securely, it may move suddenly and could cause the loss of control of the vehicle.

**Forward and backward:**

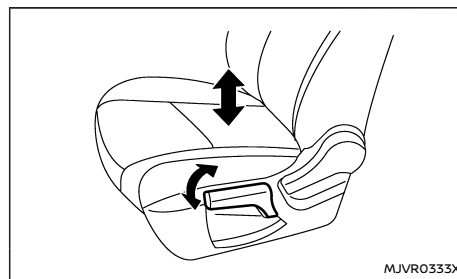
1. Pull up the adjusting lever ①.
2. Slide the seat to the desired position.
3. Release the adjusting lever to lock the seat in position.

Reclining:

1. Pull up the adjusting lever ②.
2. Tilt the seatback to the desired position.
3. Release the adjusting lever to lock the seatback in position.

The reclining feature allows the adjustment of the seatback for occupants of different sizes to help obtain the proper seat belt fit. (See "Seat belts" (P.38).)

The seatback may be reclined to allow occupants to rest when the vehicle is parked.

Seat lifter (where fitted):

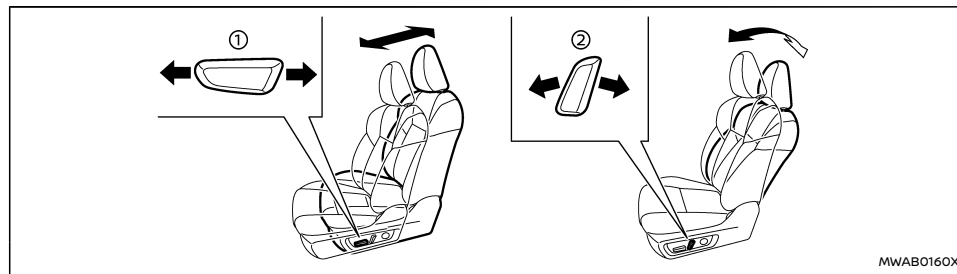
Pull up or push down the adjusting lever to adjust the seat height until the desired position is achieved.

Power seat adjustment

Operating tips:

- The power seat motor has an auto-reset overload protection circuit. If the motor stops during the seat adjustment, wait 30 seconds, then reactivate the switch.
- To avoid discharge of the 12-volt battery, do not operate the power seats for a long period of time when the e-POWER system is not running.

See "Memory seat (where fitted)" (P.187) for the seat position memory function (where fitted).



Forward and backward:

Move the adjusting switch as shown ① to the desired position.

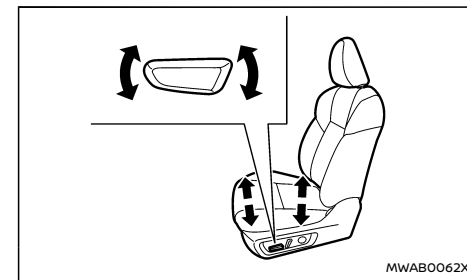
Reclining:

Move the adjusting switch as shown ② to the desired position.

The reclining feature allows the adjustment of the seatback for occupants of different sizes to help obtain the proper seat belt fit. (See "Seat belts" (P.38).)

The seatback may be reclined to allow occupants to rest when the vehicle is parked.

Seat lifter (where fitted):

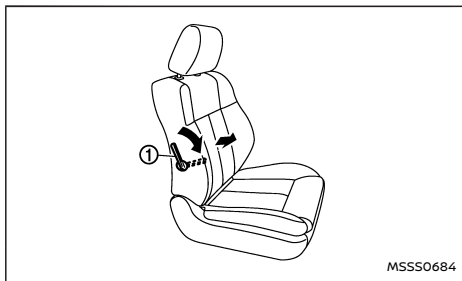


Move the switch as shown to adjust the angle of the front portion or height of the seat.

Lumbar support (where fitted)

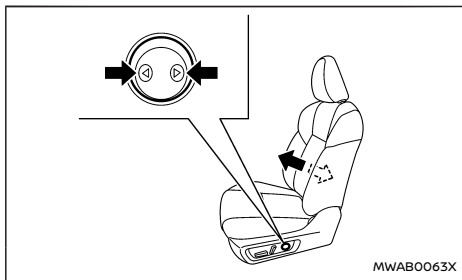
The lumbar support feature provides lower back support to the driver and front passenger (where fitted).

Manual adjustment (where fitted):



Pull or push the adjusting lever ① to adjust the seat lumbar area until the desired position is achieved.

Power adjustment (where fitted):



Push the adjusting switch as shown to adjust the seat lumbar area until the desired position is achieved.

NOTE:

The motor of the lumbar support will continue to run while the switch is pushed even after full travel in both directions is achieved.

Heated seats (where fitted)

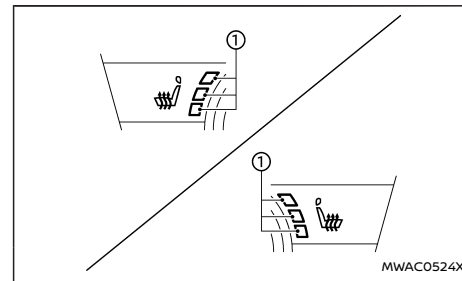
⚠ WARNING

Do not use or allow occupants to use the seat heater if you or the occupants cannot monitor elevated seat temperatures or have an inability to feel pain in body parts that contact the seat. Use of the seat heater by such people could result in serious injury.

CAUTION

- Do not use the seat heater for extended periods or when no one is using the seat.
- Do not put anything on the seat which insulates heat, such as a blanket, cushion, non-genuine seat cover, etc. Otherwise, the seat may become overheated.
- Do not place anything hard or heavy on the seat or pierce it with a pin or similar object. This may result in damage to the heater.
- Any liquid spilled on the heated seat should be removed immediately with a dry cloth.
- When cleaning the seat, never use petrol, thinner, or any similar materials.

- If any malfunctions are found or the heated seat does not operate properly, turn the switch off and have the system checked by a NISSAN dealer or qualified workshop.



The front seats are warmed by built-in heaters. The switches are located on the instrument panel and can be operated independently of each other.

Operation with switch:

1. Start the e-POWER system.
2. Push the heated seat switch and select the desired heat range.
 - For high heat, push the switch once.
 - For medium heat, push the switch twice.
 - For low heat, push the switch three times.
 - The indicator light ① on the switch will illuminate depending on the heat level when the heater is on.

- To turn off the heater, push the heated seat switch until the indicator light turns off.

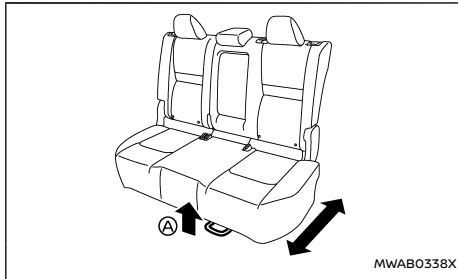
The heater is controlled by a control module, automatically adjusting the heat level to maintain comfort according to the selected heat range.

The indicator light will remain on as long as the switch is on.

When the vehicle's interior is warmed, or before you leave the vehicle, be sure to turn off the seat heater.

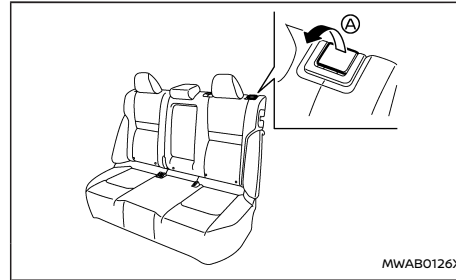
SECOND ROW SEATS

Forward and backward (where fitted)



- Pull up the adjusting lever **A**.
- Slide the seat to the desired position.
- Release the adjusting lever **A** to lock the seat in position.

Reclining



- Pull up the lever **A**.
- Tilt the seatback to the desired position.
- Release the lever **A** to lock the seatback in position.

⚠ WARNING

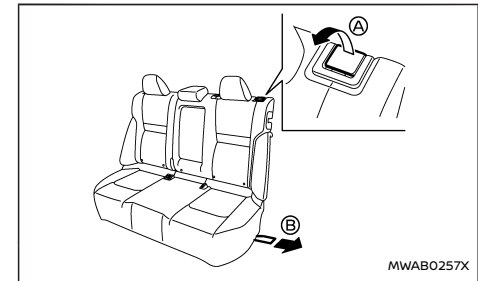
- After adjustment, gently rock in the seat to make sure it is securely locked.
- Do not ride in a moving vehicle when the seatback is reclined. This can be dangerous. The shoulder belt will not be against your body. In an accident, you could be thrown into it and receive neck or other serious injuries. You could also slide under the lap belt and receive serious internal injuries.
- For the most effective protection when the vehicle is in motion, the seat should be upright. Always sit well back and upright in

the seat with both feet on the floor and adjust the seat belt properly. (See "Precautions on seat belt usage" (P.38).)

Folding

Before folding the second row seats

- Secure the outer seat belt on the seat belt hook. (See "Seat belt hooks" (P.42).)
- If the second row seat is equipped with the head restraints, slide the front seat forward to make enough room behind the seat so that the second row seatback can be folded flat.
- Remove drink containers from the second row cup holder.



To fold down the seatback

- Two row model: Pull up the lever **A** and fold the seatback.
- Three row model: Pull the strap **B** on the lower side of the outboard seats to fold the seatback.

To return the seatback

To return the seatback to a seating position, raise the seatback until it latches in place.

When returning the seatback, make sure that the seat belts are not interfering with the seatback latch mechanism.

WARNING

- Never allow anyone to ride in the cargo area or on the second row seats when they are in the fold-down position. In a collision, people riding in these areas without proper restraints are more likely to be seriously injured or killed.
- Do not allow people to ride in any area of your vehicle that is not equipped with seats and seat belts. Be sure everyone in your vehicle is in a seat and using a seat belt properly.
- Do not allow more than one person to use the same seat belt.
- Do not fold down the second row seats when occupants are in the second row seat area or any luggage is on the second row seats.
 - Make sure that the seat path is clear before moving the seat.
 - Be careful not to allow hands or feet to get caught or pinched in the seat.
- Head restraints should be adjusted properly as they may provide significant protection against injury in an accident.

Always replace and adjust them properly if they have been removed for any reason.

- If the head restraints are removed for any reason, they should be securely stored to prevent them from causing injury to passengers or damage to the vehicle in case of sudden braking or an accident.
- When returning the seatbacks to the upright position, be certain they are completely secured in the latched position. If they are not completely secured, passengers may be injured in an accident or sudden stop.
- Properly secure all cargo to help prevent it from sliding or shifting. Do not place cargo higher than the seatbacks. In a sudden stop or collision, unsecured cargo could cause personal injury.

Walk-in mechanism (Three row model)

The second row seats can tilt and slide for easy entry/exit to/from the third row seats.

WARNING

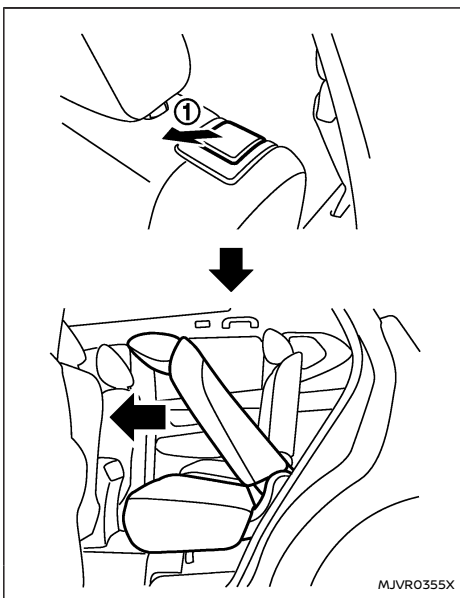
After operating the walk-in mechanism, be sure to return the seat to the rearmost position and then tilt up the seatback until it latches.

CAUTION

- When operating the walk-in mechanism, push and hold the seatback and operate slowly. If the seatback is tilted down quickly and then allowed to slide, there is

a risk that it could contact your face or other parts of your body, or pinch your hand or foot, causing injury.

- When operating the walk-in mechanism, be sure not to contact any moving parts to avoid possible injuries and/or damage.
- When operating the walk-in mechanism, be sure that the second row seats are not occupied by passengers and/or any objects to avoid possible injuries and/or damage.
- Do not operate the walk-in mechanism with objects, drinks, etc. on the seat. This may cause objects to break or cause the passenger room to be soiled.



1. Pull the lever ① to tilt down the seatback.
2. Slide the seat forward.
3. When returning the seat to its original position, slide the seat backward, tilt the seatback up and then secure it in place.

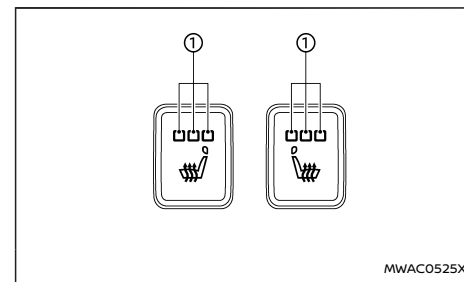
Heated seats (where fitted)

⚠ WARNING

Do not use or allow occupants to use the seat heater if you or the occupants cannot monitor elevated seat temperatures or have an inability to feel pain in body parts that contact the seat. Use of the seat heater by such people could result in serious injury.

CAUTION

- Do not use the seat heater for extended periods or when no one is using the seat.
- Do not put anything on the seat which insulates heat, such as a blanket, cushion, non-genuine seat cover, etc. Otherwise, the seat may become overheated.
- Do not place anything hard or heavy on the seat or pierce it with a pin or similar object. This may result in damage to the heater.
- Any liquid spilled on the heated seat should be removed immediately with a dry cloth.
- When cleaning the seat, never use petrol, thinner, or any similar materials.
- If any malfunctions are found or the heated seat does not operate properly, turn the switch off and have the system checked by a NISSAN dealer or qualified workshop.



The second row seats are warmed by built-in heaters. The switches are located on the back of the centre console and can be operated independently of each other.

Operation with switch:

1. Start the e-POWER system.
2. Push the heated seat switch and select the desired heat range.
 - For high heat, push the switch once.
 - For medium heat, push the switch twice.
 - For low heat, push the switch three times.
 - The indicator light ① on the switch will illuminate depending on the heat level when the heater is on.
3. To turn off the heater, push the heated seat switch until the indicator light turns off.

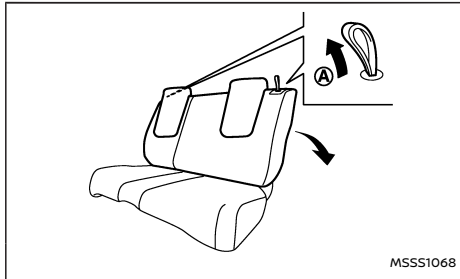
The heater is controlled by a control module, automatically adjusting the heat level to maintain comfort according to the selected heat range.

The indicator light will remain on as long as the switch is on.

When the vehicle's interior is warmed, or before you leave the vehicle, be sure to turn off the seat heater.

THIRD ROW SEATS (where fitted)

Reclining



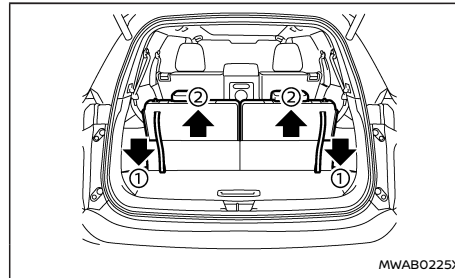
Pull the strap **A** and position the seatback at the desired angle. Release the strap after positioning the seat at the desired angle.

The reclining feature allows adjustment of the seatback for occupants of different sizes to help obtain proper seat belt fit. (See "Seat belts" (P.38).) The seatback may also be reclined to allow occupants to rest when the vehicle is parked.

⚠ WARNING

- **Do not ride in a moving vehicle when the seatback is reclined. This can be dangerous. The shoulder belt will not be against your body. In an accident, you could be thrown into it and receive neck or other serious injuries. You could also slide under the lap belt and receive serious internal injuries.**
- **For the most effective protection when the vehicle is in motion, the seat should be upright. Always sit well back and upright in the seat with both feet on the floor and adjust the seat belt properly. See "Precautions on seat belt usage" (P.38).**
- **After adjustment, check to be sure the seat is securely locked.**

Folding



Before folding the third row seats, secure the outer seat belt on the seat belt hook. (See "Seat belt hooks" (P.42).)

To fold the third row seats flat for maximum cargo capacity:

1. Make sure the head restraints are all the way down.
2. Pull the strap **1** to release the seat.
3. Once released, push the seatback forward **2**.

To return the third row seats to a seating position:

Use the pull straps **1** to raise each seatback. Pull back until the seatback latches into position. Make sure to properly raise each seatback to an upright and secured position.

⚠ WARNING

- **Never allow anyone to ride in the cargo area or on the third row seat when it is in the fold-down position. Use of these areas by passengers without proper restraints could result in serious injury in an accident or sudden stop.**
- **Properly secure all cargo with ropes or straps to help prevent it from sliding or shifting. Do not place cargo higher than the seatbacks. In a sudden stop or collision, unsecured cargo could cause personal injury.**
- **When returning the seatbacks to the upright position, be certain they are completely secured in the latched position. If they are not completely secured, passengers may be injured in an accident or sudden stop.**

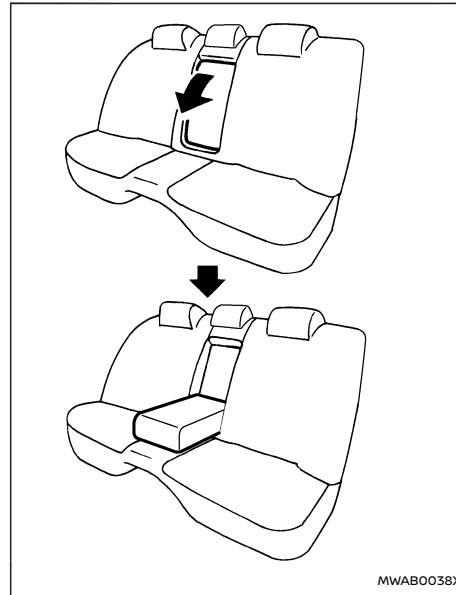
- When the seat is returned to the normal seating position, the head restraints must be returned to the upright position to properly protect vehicle occupants.

ARMREST

Second row seat

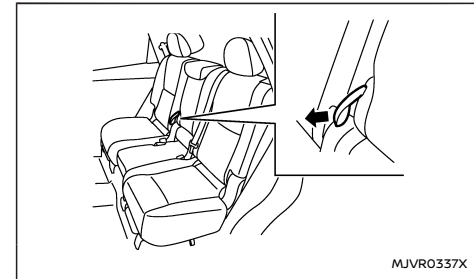
The centre seatback can be folded to make the armrest.

Two row model:



Fold down the seatback until it is horizontal.

Three row model:



Pull the strap to unlatch the seatback and fold it down until it is horizontal.

HEAD RESTRAINTS

⚠ WARNING

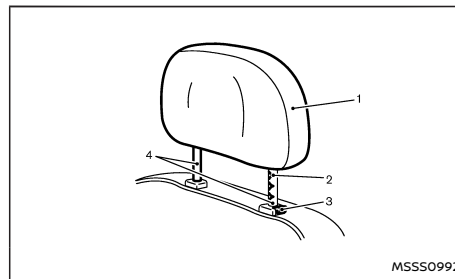
Head restraints supplement the other vehicle safety systems. They may provide additional protection against injury in certain rear end collisions. Adjustable head restraints must be adjusted properly, as specified in this section. Check the adjustment after someone else uses the seat. Do not attach anything to the head restraint stalks or remove the head restraint. Do not use the seat if the head restraint has been removed. If the head restraint was removed, reinstall and properly adjust the head restraint before an occupant uses the seating position. Failure to follow these instructions can reduce the effectiveness of the head restraint. This may increase the risk of serious injury or death in a collision.

- Your vehicle is equipped with a head restraint that may be integrated, adjustable or non-adjustable.
- Adjustable head restraints have multiple notches along the stalk to lock them in a desired adjustment position.
- The non-adjustable head restraints have a single locking notch to secure them to the seat frame.
- Proper Adjustment:
 - For the adjustable type, align the head restraint so the centre of your ear is approximately level with the centre of the head restraint.
 - If your ear position is still higher than the

recommended alignment, place the head restraint at the highest position.

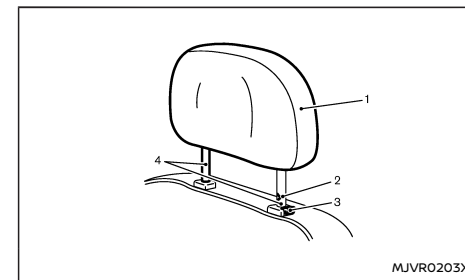
- If the head restraint has been removed, ensure that it is reinstalled and locked in place before riding in that designated seating position.

ADJUSTABLE HEAD RESTRAINT COMPONENTS



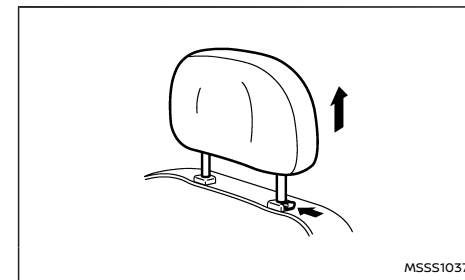
1. Removable head restraint
2. Multiple notches
3. Lock knob
4. Stalks

NON-ADJUSTABLE HEAD RESTRAINT COMPONENTS



1. Removable head restraint
2. Single notch
3. Lock knob
4. Stalks

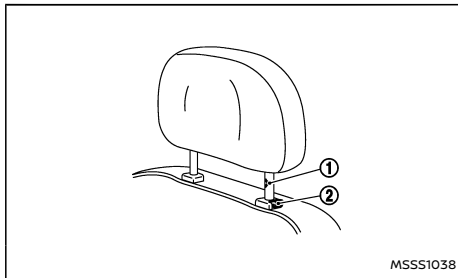
REMOVE



Use the following procedure to remove the head restraint.

1. Pull the head restraint up to the highest position.
2. Push and hold the lock knob.
3. Remove the head restraint from the seat.
4. Store the head restraint properly in a secure place so it is not loose in the vehicle.
5. Reinstall and properly adjust the head restraint before an occupant uses the seating position.

INSTALL



1. Align the head restraint stalks with the holes in the seat. Make sure that the head restraint is facing the correct direction. The stalk with the adjustment notch ① must be installed in the hole with the lock knob ②.
2. Push and hold the lock knob and push the head restraint down.

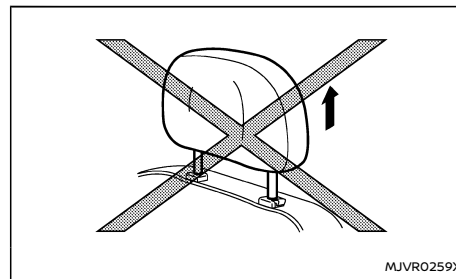
3. Properly adjust the head restraint before an occupant uses the seating position.

ADJUST



For adjustable head restraint

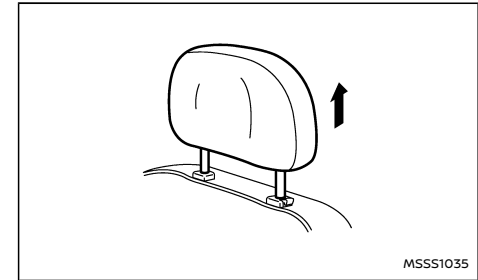
Adjust the head restraint so the centre is level with the centre of your ears. If your ear position is still higher than the recommended alignment, place the head restraint at the highest position.



For non-adjustable head restraint

Make sure the head restraint is positioned from the stored position or any non-latch position so the lock knob is engaged in the notch before riding in that designated seating position.

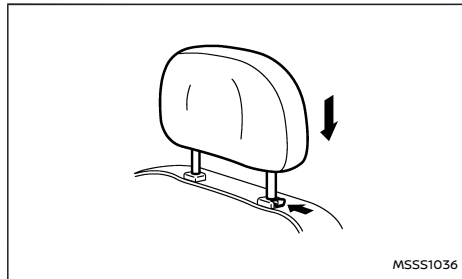
Raise



To raise the head restraint, pull it up.

Make sure the head restraint is positioned from the stored position or any non-latch position so the lock knob is engaged in the notch before riding in that designated seating position.

Lower



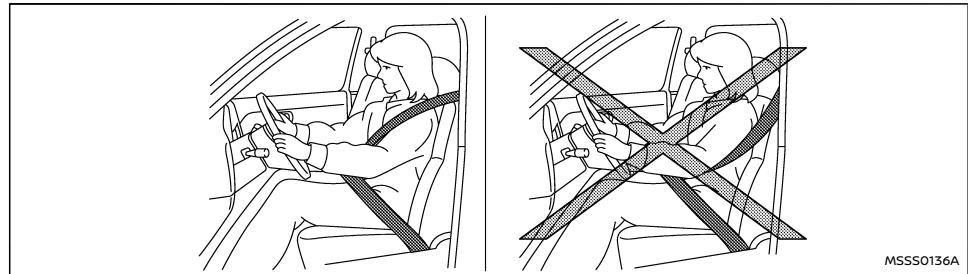
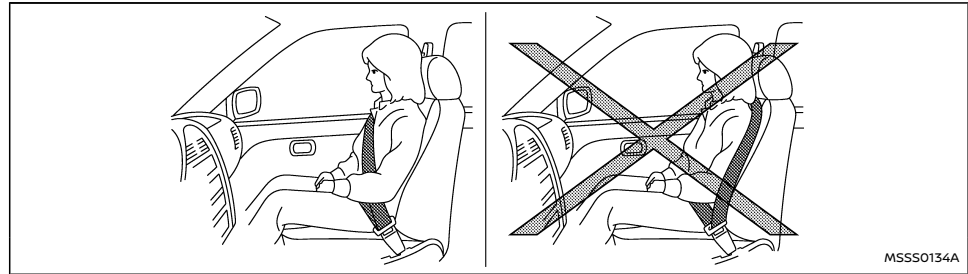
To lower, push and hold the lock knob and push the head restraint down.

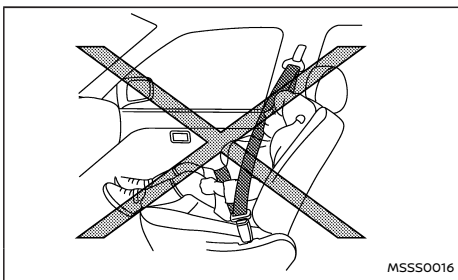
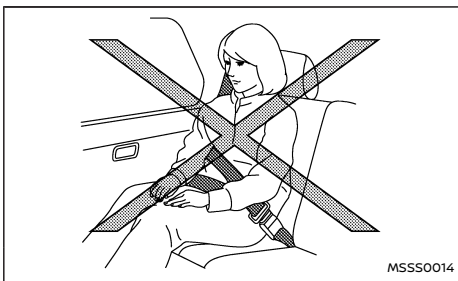
Make sure the head restraint is positioned so the lock knob is engaged in the notch before riding in that designated seating position.

SEAT BELTS

PRECAUTIONS ON SEAT BELT USAGE

If you are wearing the seat belt properly adjusted and sitting upright and well back in the seat, chances of being injured or killed in an accident and/or the severity of injury may be greatly reduced. NISSAN strongly encourages you and all of your passengers to buckle up every time you drive, even if your seating position includes the supplemental air bag systems.





⚠ WARNING

- Seat belts are designed to bear upon the bony structure of the body, and should be worn low across the front of the pelvis or the pelvis, chest and shoulders, as applicable; wearing the lap section of the belt across the abdominal area must be avoided. Serious injury may occur if a seat belt is not worn properly.

- Position the lap belt as low and snug as possible around the hips, not the waist. A lap belt worn too high could increase the risk of internal injuries in an accident.
- Do not allow more than one person to use the same seat belt. Each belt assembly must only be used by one occupant; it is dangerous to put a belt around a child being carried on the occupant's lap.
- Never carry more people in the vehicle than there are seat belts.
- Never wear seat belts inside out. Belts should not be worn with straps twisted. Doing so may reduce their effectiveness.
- Seat belts should be adjusted as firmly as possible, consistent with comfort, to provide the protection for which they have been designed. A slack belt will greatly reduce the protection afforded to the wearer.
- Every person who drives or rides in this vehicle should use a seat belt at all times. Children should be properly restrained in the rear seat and, if appropriate, in a child restraint system.
- Do not put the belt behind your back or under your arm. Always route the shoulder belt over your shoulder and across your chest. The belt should be away from your face and neck, but not falling off your shoulder. Serious injury may occur if a seat belt is not worn properly.
- No modifications or additions should be

made by the user which will either prevent the seat belt adjusting devices from operating to remove slack, or prevent the seat belt assembly from being adjusted to remove slack.

- Care should be taken to avoid contamination of the webbing with polishes, oils and chemicals, and particularly battery acid. Cleaning may safely be carried out using mild soap and water. The belt should be replaced if webbing becomes frayed, contaminated or damaged.
- All seat belt assemblies including retractors and attaching hardware should be inspected after any collision by a NISSAN dealer or qualified workshop. NISSAN recommends that all seat belt assemblies in use during a collision be replaced unless the collision was minor and the belts show no damage and continue to operate properly. Seat belt assemblies not in use during a collision should also be inspected and, when necessary, replaced if either damage or improper operation is noted.
- It is essential to replace the entire assembly after it has been worn in a severe impact even if damage to the assembly is not obvious.
- Once the pre-tensioner seat belt has activated, it cannot be reused. It must be replaced together with the retractor. Contact a NISSAN dealer or qualified workshop.
- Removal and installation of the pre-ten-

tioner seat belt system components should be done by a NISSAN dealer or qualified workshop.

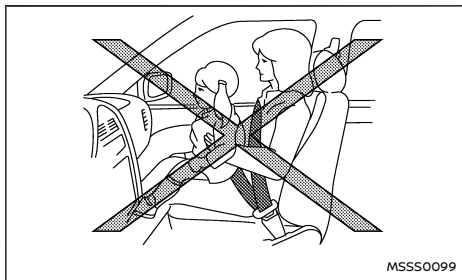
CHILD SAFETY

⚠ WARNING

- **Infants and children need special protection.** The vehicle's seat belts may not fit them properly. The shoulder belt may come too close to the face or neck. The lap belt may not fit over their small hipbones. In an accident, an improperly fitted seat belt could cause serious or fatal injury.
- **Always use an appropriate child restraint system.**

Children need adults to help protect them. They need to be properly restrained. The proper restraint depends on the child's size.

Infants and small children



NISSAN recommends that infants and small children be seated in a child restraint system. You should choose a child restraint system that fits your vehicle and the child, and always follow the manufacturer's instructions for installation and use.

Large children

⚠ WARNING

- **Never allow children to stand or kneel on any seats.**
- **Never allow children in the cargo areas while the vehicle is moving. A child could be seriously injured in an accident or sudden stop.**

Children who are too large for a child restraint system should be seated and restrained by the seat belts that are provided.

If the child's seating position has a shoulder belt that fits close to the face or neck, the use of a booster seat (commercially available) may help overcome this. The booster seat should raise the child so that the shoulder belt is properly positioned across the top, middle portion of the shoulder and the lap belt is low on the hips. The booster seat should also fit the vehicle seat. Once the child has grown so that the shoulder belt is no longer on or near the face or neck of the child, use the shoulder belt without the booster seat. In addition, there are many types of child restraint systems available for larger children that should be used for maximum protection.

PREGNANT WOMEN

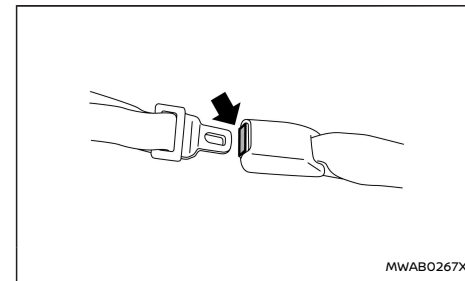
NISSAN recommends that pregnant women use seat belts. The seat belt should be worn snug, and always position the lap belt as low as possible around the hips, not the waist. Place the shoulder belt over your shoulder and across your chest. Never put the lap/shoulder belt over your abdominal area. Contact your doctor for specific recommendations.

INJURED PERSONS

NISSAN recommends that injured persons use seat belts. Contact your doctor for specific recommendations.

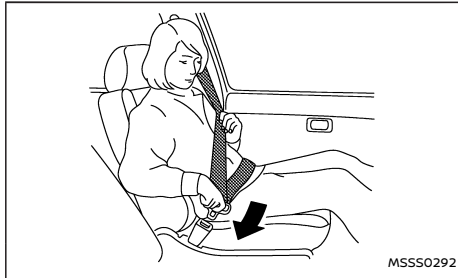
CENTRE MARK ON SEAT BELTS

Selecting correct set of seat belts



The centre seat belt buckle is identified by the CENTER mark. The centre seat belt tongue can be fastened only into the centre seat belt buckle.

THREE-POINT TYPE SEAT BELTS



⚠ WARNING

Every person who drives or rides in this vehicle should use a seat belt at all times.

Fastening seat belts

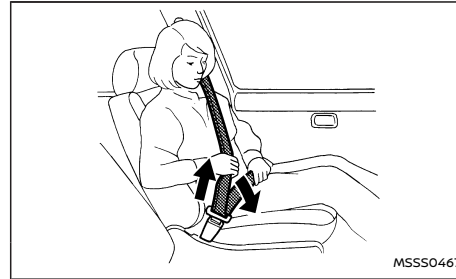
⚠ WARNING

The seatback should not be in a reclined position any more than needed for comfort. Seat belts are most effective when the passenger sits well back and straight up in the seat.

1. Adjust the seat. (See "Seats" (P.26).)
2. Slowly pull the seat belt out of the retractor and insert the tongue into the buckle until you hear and feel the latch engage.
 - **The retractor is designed to lock during a sudden stop or on impact. A slow pulling**

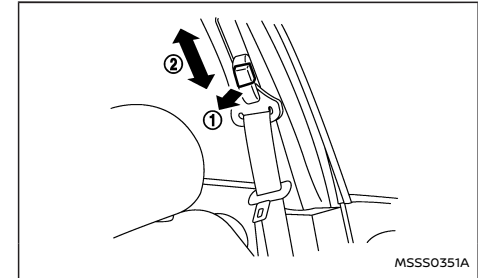
motion permits the seat belt to move, and allows you some freedom of movement in the seat.

- If the seat belt cannot be pulled from its fully retracted position, firmly pull the belt and release it. Then smoothly pull the belt out of the retractor.



3. Position the lap belt portion low and snug on the hips as shown.
4. Pull the shoulder belt portion toward the retractor to take up extra slack. Be sure the shoulder belt is routed over your shoulder and is snug across your chest.

Shoulder belt height adjustment (for front seats)



⚠ WARNING

- The shoulder belt anchor height should be adjusted to the position best for you. Failure to do so may reduce the effectiveness of the entire restraint system and increase the chance or severity of injury in an accident.
- The shoulder belt should rest on the middle of the shoulder. It must not rest against the neck.
- Be sure that the seat belt is not twisted in any way.
- Be sure that the shoulder belt anchor is secured by trying to move the shoulder belt anchor up and down after adjustment.

The shoulder belt anchor height should be adjusted to the position best for you.

The belt should be away from your face and neck, but not falling off your shoulder.

To adjust, pull out the release button ① and move the shoulder belt anchor to the proper position ②, so that the belt passes over the centre of the shoulder.

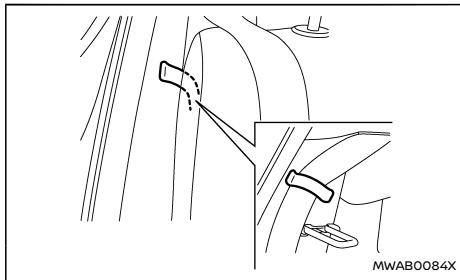
Release the button to lock the shoulder belt anchor into position.

Unfastening seat belts

Push the button on the buckle. The seat belt automatically retracts.

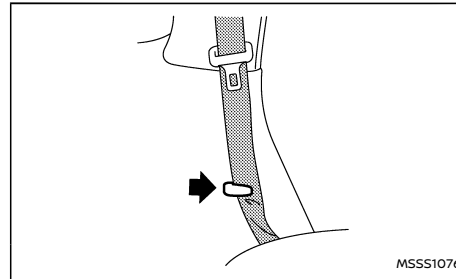
Seat belt hooks

Second row seat:



When folding down the second row seats, hook the second row outer seat belts on the seat belt hooks.

Third row seat (where fitted):



When folding down the third row seats, hook the third row seat belts on the seat belt hooks.

Checking seat belt operation

Seat belt retractors are designed to lock seat belt movement:

- When the seat belt is pulled quickly from the retractor.
- When the vehicle slows down rapidly.

To increase your confidence in the seat belts, check the operation by grasping the shoulder belt and pulling forward quickly. The retractor should lock and restrict further belt movement. If the retractor does not lock during this check, contact a NISSAN dealer or qualified workshop immediately.

SEAT BELT MAINTENANCE

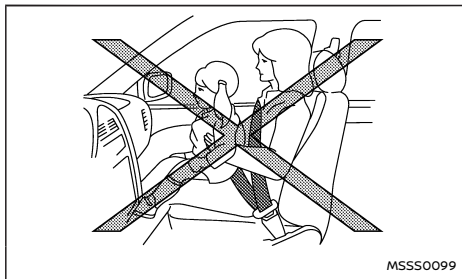
Periodically check that the seat belt and all the metal components, such as buckles, tongues, retractors, flexible wires and anchors, work properly. If loose parts, deterioration, cuts or other damage on the seat belt webbing is found, the entire seat belt assembly should be replaced.

If dirt builds up in the shoulder belt guide of the seat belt anchors, the seat belts may retract slowly. Wipe the shoulder belt guide with a clean, dry cloth.

To clean the seat belt webbing, apply a mild soap solution or any solution recommended for cleaning upholstery or carpet. Then wipe with a cloth and allow the seat belts to dry in the shade. Do not allow the seat belts to retract until they are completely dry.

CHILD RESTRAINTS

PRECAUTIONS ON CHILD RESTRAINT USAGE



⚠ WARNING

- Infants and small children should always be placed in an appropriate child restraint while riding in the vehicle. Failure to use a child restraint can result in serious injury or death.
- Infants and small children should never be carried on your lap. It is not possible for even the strongest adult to resist the forces of a severe accident. The child could be crushed between the adult and parts of the vehicle. Also, do not put the same seat belt around both your child and yourself.
- NISSAN recommends that the child restraints be installed in the rear seat. According to accident statistics, children are safer when properly restrained in the rear seat than in the front seat.
- Improper use or improper installation of a

child restraint can increase the risk or severity of injury for both the child and other occupants of the vehicle and can lead to serious injury or death in an accident.

- Follow all of the child restraint manufacturer's instructions for installation and use. When purchasing a child restraint, be sure to select one which will fit your child and vehicle. It may not be possible to properly install some types of child restraint in your vehicle.
- The direction of the child restraint, either front-facing or rear-facing, depends on the type of the child restraint and the size of the child. Refer to the child restraint manufacturer's instructions for details.
- After attaching a child restraint, test it before you place the child in it. Push it from side to side and tug it forward to make sure that it is held securely in place. The child restraint should not move more than 25 mm (1 in). If the restraint is not secure, tighten the belt as necessary, or install the restraint in another seat and test it again.
- When the child restraint is not in use, keep it secured with the ISOFIX child restraint system or a seat belt to prevent it from being thrown around in case of a sudden stop or accident.
- Adjustable seatbacks should be positioned to ensure full contact between child restraint and seatback.

- Never install a rear-facing child restraint on the front passenger seat without ensuring that the supplemental front passenger air bag is deactivated. Supplemental front-impact air bags inflate with great force. A rear-facing child restraint could be struck by the supplemental front-impact air bags in an accident and could seriously injure or kill your child.
- If the seat belt in the position where a child restraint is installed requires a locking device and if it is not used, injuries could result from a child restraint tipping over during normal vehicle braking or cornering.

CAUTION

Remember that a child restraint left in a closed vehicle can become very hot. Check the seating surface and buckles before placing your child in a child restraint.

NISSAN recommends that infants and small children be seated in a child restraint. You should choose a child restraint that fits your vehicle and always follow the manufacturer's instructions for installation and use. In addition, there are many types of child restraints available for larger children that should be used for maximum protection.

UNIVERSAL CHILD RESTRAINTS FOR FRONT SEAT AND REAR SEATS

NOTE:

Universal child restraints approved to UN Regulation No.44 (UN R44) or UN Regulation No.129 (UN R129) are clearly marked "Universal".

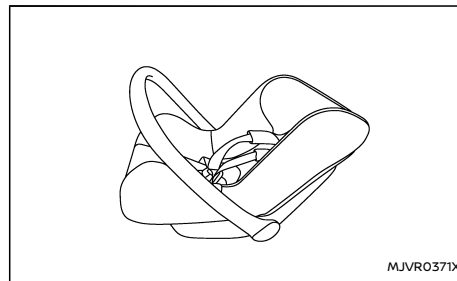
When selecting any child restraint, keep the following points in mind:

- Choose a child restraint that complies with the UN R44 or UN R129.
- Place your child in the child restraint and check the various adjustments to be sure the child restraint is compatible with your child. Always follow all of the recommended procedures.
- Check the child restraint in your vehicle to be sure it is compatible with vehicle's seat belt system.
- Refer to the tables later in this section for a list of the recommended fitment positions and the approved child restraints for your vehicle.

Mass group of child seat

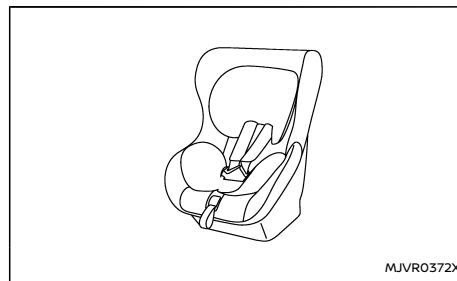
Mass group	Child's weight
Group 0	up to 10 kg
Group 0+	up to 13 kg
Group I	9 to 18 kg
Group II	15 to 25 kg
Group III	22 to 36 kg

Kind of child seats (example):



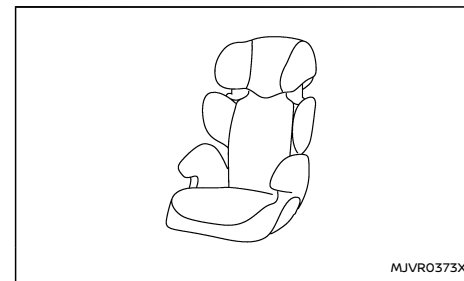
MJVR0371X

Child safety seat categories 0 and 0+



MJVR0372X

Child safety seat categories 0+ and I

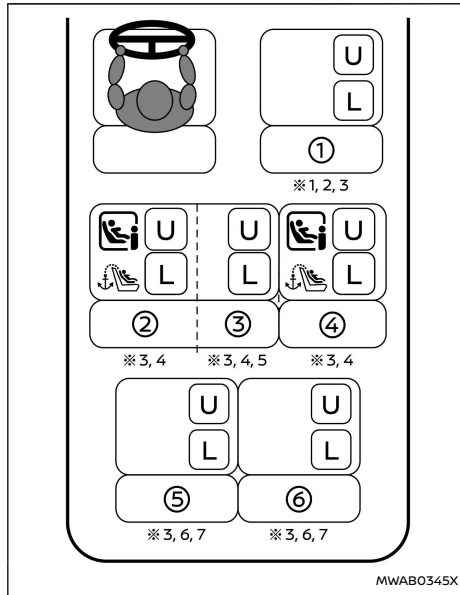


MJVR0373X

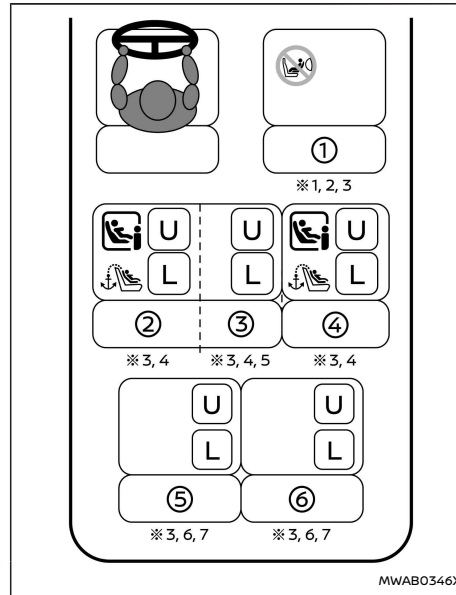
Child safety seat categories II and III

Selecting the child restraint system for each seating position

A child restraint system that can be used differs according to the seating position.



<PASSENGER AIR BAG OFF> indicator illuminated



<PASSENGER AIR BAG ON> indicator illuminated

①	Front passenger seat
②	Row 2: left hand outboard seat
③	Row 2: centre seat
④	Row 2: right hand outboard seat
⑤	Row 3: left seat (for three row model)
⑥	Row 3: right seat (for three row model)
U	Suitable for child safety seats that are fixed with vehicle seat belt
	Suitable for i-Size child safety seats
	Prohibit installation of rearward facing child restraint system
	Seats equipped with top tether anchor
L	Suitable for child safety seats listed in the attached list

*1: Adjust the seat slide to the rearmost position.

- *2: Adjust the seat lifter to the uppermost position.
- *3: Move the head restraint to the uppermost position or remove it (and store securely) if there is any interference with the child restraint. Do not remove head restraint when using a booster cushion only.
- *4: Adjust the front seat slide to the centre position.
- *5: Do not install child restraints with a support leg.
- *6: Adjust the second seat slide to the front most position.
- *7: Adjust the second seat backrest to the first locking position.

Detailed information for child restraint system installation:

Seat position number	Front		Second row			Third row	
	①		②	③	④	⑤	⑥
	Air Bag Activation	Air Bag Deactivation	Left	Centre	Right	Left	Right
Seating position suitable for universal belted (Yes/No)	No	Yes	Yes	Yes	Yes	Yes	Yes
i-Size seating position (Yes/No)	No	No	Yes	No	Yes	No	No
Seating position suitable for lateral fixture (L1/L2)	—	—	—	—	—	—	—
Largest suitable rearward facing fixture (R1/R2X/R2/R3)	—	—	R3	—	R3	—	—
Largest suitable forward facing fixture (F2X/F2/F3)	—	—	F3	—	F3	—	—
Largest suitable booster fixture (B2/B3)	—	—	B3	—	B3	—	—

List of recommended child restraints:

Age (approx.)	Weight (approx.)	Height (approx.)	CRS Mass Category	Recommend CRS	CRS suitable seat position						
					①	①**	②**	③**	④**	⑤**	⑥**
					Air bag Activation	Air bag Deactivation					
0 - 12 months	Up to 10 kg	< 75 cm	0	Maxi Cosi 2way Pearl + 2wayFix Base	No	No	Yes	No	Yes	No	No
0 - 18 months	Up to 13 kg	< 85 cm	0+		No	No	Yes	No	Yes	No	No
9 months - 4 years old	9 - 18 kg	76 - 105 cm	I	Britax Römer Trifix 2 i-Size	No	No	Yes	No	Yes	No	No
4 - 6 years old	15 - 25 kg	100 - 125 cm	II	Britax Römer Kidfix i-Size*	No	Yes (Belt only)	Yes	Yes (Belt only)	Yes	Yes (Belt only)	Yes (Belt only)
6 - 10 years old	22 - 36 kg	> 125 cm	III	Britax Römer Kidfix i-Size*	No	Yes (Belt only)	Yes	Yes (Belt only)	Yes	Yes (Belt only)	Yes (Belt only)

* It is recommended to use the lap belt Secure Guard, SICT and XP-Pad when using the Kidfix i-Size.

** Move the head restraint to the uppermost position or remove it (and store securely) if there is any interference with the child restraint. Do not remove head restraint when using a booster cushion only.

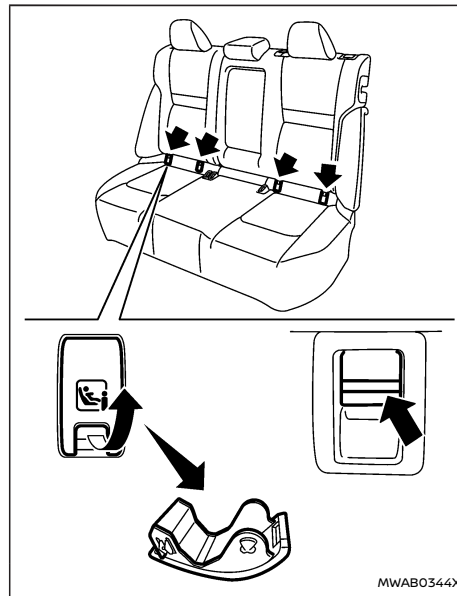
ISOFIX CHILD RESTRAINT SYSTEM (for second row seats)

Your vehicle is equipped with special anchor points that are used with ISOFIX child restraint systems.

ISOFIX lower anchor point locations

The ISOFIX anchor points are provided to install child restraints in the second row outboard seating positions only. **Do not attempt to install a child restraint in the centre position using the ISOFIX anchors.**

Type A:

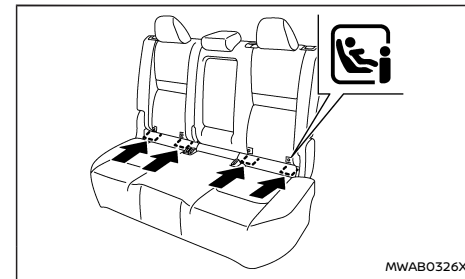


The ISOFIX lower anchor points are located under covers labelled ISOFIX at the bottom of the rear seat cushions. To access a ISOFIX lower anchor point, insert your finger into the cover and pull the cover off.

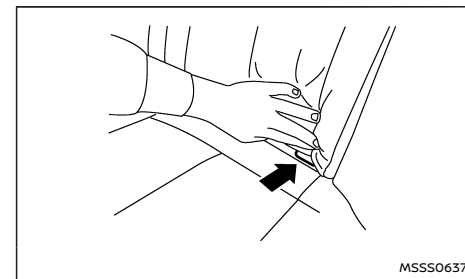
CAUTION

Store the loose ISOFIX covers (for example, in the console box) where they will not get damaged to avoid losing them. (See "Console box" (P.141).)

Type B:



ISOFIX label location

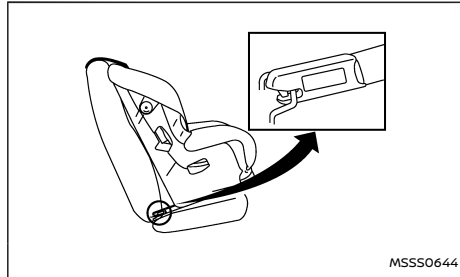


ISOFIX lower anchor location

The ISOFIX anchors are located at the rear of the

seat cushion near the seatback. A label is attached to the seatback to help you locate the ISOFIX anchors.

ISOFIX child restraint anchor attachments



Anchor attachment

ISOFIX child restraints include two rigid attachments that can be connected to two anchors located in the seat. With this system, you do not have to use a vehicle seat belt to secure the child restraint. Check your child restraint for a label stating that it is compatible with the ISOFIX child restraints. This information may also be in the instructions provided by the child restraint manufacturer.

ISOFIX child restraints generally require the use of a top tether strap or other anti-rotation devices such as support legs. When installing ISOFIX child restraints, carefully read and follow the instructions in this manual and those supplied with the child restraints. (See "Child restraint installation using ISOFIX (for second row seats)" (P.50).)

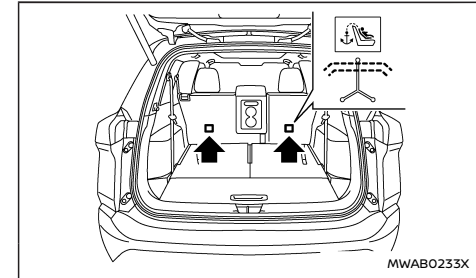
CHILD RESTRAINT ANCHORAGE (for second row seats)

Your vehicle is designed to accommodate a child restraint system on the second row seat. When installing a child restraint system, carefully read and follow the instructions in this manual and those supplied with the child restraint system.

⚠ WARNING

- **Child restraint anchorages are designed to withstand only those loads imposed by correctly fitted child restraints. Under no circumstances are they to be used for adult seat belts, harnesses or for attaching other items or equipment to the vehicle. Doing so could damage the child restraint anchorages. The child restraint will not be properly installed using the damaged anchorage, and a child could be seriously injured or killed in a collision.**
- **The child restraint top tether strap may be damaged by contact with the tonneau cover or items in the luggage area. Remove the tonneau cover from the vehicle or secure it and any luggage. Your child could be seriously injured or killed in a collision if the top tether strap is damaged.**

Anchorage location



Anchorage locations are illustrated. Position the top tether strap over the top of the seatback and secure it to the tether anchorage that provides the straightest installation. Tighten the tether strap according to the manufacturer's instruction to remove any slack.

CHILD RESTRAINT INSTALLATION USING ISOFIX (for second row seats)

⚠ WARNING

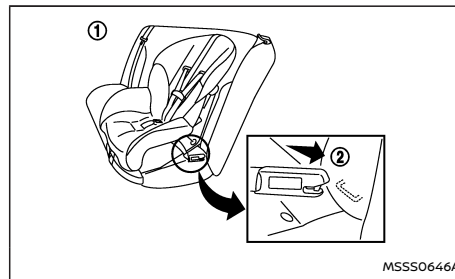
- **Attach ISOFIX child restraints only at the specified locations. For the ISOFIX lower anchor locations, see "ISOFIX child restraint system (for second row seats)" (P.49). If a child restraint is not secured properly, your child could be seriously injured or killed in an accident.**
- **Do not install child restraints that require the use of a top tether strap to seating**

positions that do not have a top tether anchor.

- Do not secure a child restraint in the centre rear seating position using the ISOFIX lower anchors. The child restraint will not be secured properly.
- Inspect the lower anchors by inserting your fingers into the lower anchor area and feeling to make sure there are no obstructions over the ISOFIX anchors, such as seat belt webbing or seat cushion material. The child restraint will not be secured properly if the ISOFIX anchors are obstructed.
- Child restraint anchorages are designed to withstand only those loads imposed by correctly fitted child restraints. Under no circumstances are they to be used for adult seat belts, harnesses or for attaching other items or equipment to the vehicle. Doing so could damage the child restraint anchorages. The child restraint will not be properly installed using the damaged anchorage, and a child could be seriously injured or killed in a collision.

Installation on second row outboard seats

Front-facing:

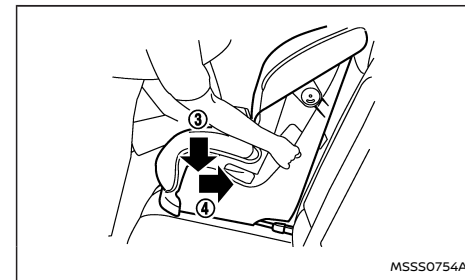


Front-facing: Steps 1 and 2

Be sure to follow the manufacturer's instructions for the proper use of your child restraint. Follow these steps to install a front-facing child restraint on the second row outboard seats using ISOFIX:

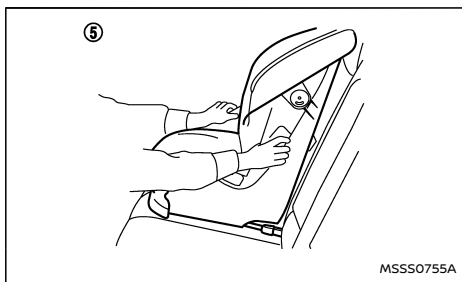
1. Position the child restraint on the seat ①.
2. Secure the child restraint anchor attachments to the ISOFIX lower anchors ②.
3. The back of the child restraint should be secured against the vehicle seat back. If necessary, remove the head restraint to obtain the correct child restraint fit. (See "Head restraints" (P.35).) If the head restraint is removed, store it in a secure place. Be sure to install the head restraint when the child restraint is removed. If the seating position does not have an adjustable head restraint and it is interfering with the proper child

restraint fit, try another seating position or a different child restraint.



Front-facing: Step 4

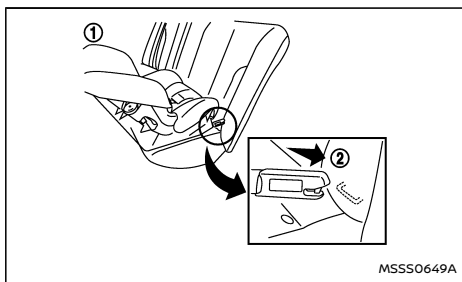
4. Shorten the rigid attachment to have the child restraint firmly tightened; press downward ③ and rearward ④ firmly in the centre of the child restraint with your knee to compress the vehicle seat cushion and seatback.
5. If the child restraint is equipped with a top tether strap, route the top tether strap and secure the tether strap to the tether anchor point. (See "Child restraint anchorage (for second row seats)" (P.50).)
6. If the child restraint is equipped with other anti-rotation devices such as support legs, use them instead of the top tether strap following the child restraint manufacturer's instructions.



Front-facing: Step 7

7. Test the child restraint before you place the child in it ⑤. Push the child restraint from side to side and tug it forward to make sure that it is held securely in place.
8. Check to make sure that the child restraint is properly secured prior to each use. If the child restraint is loose, repeat steps 3 through 7.

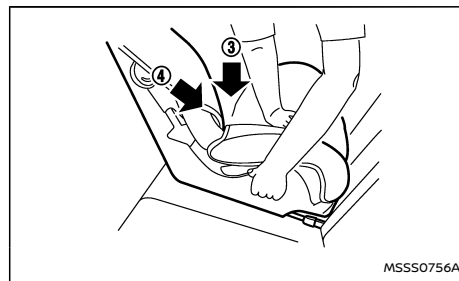
Rear-facing:



Rear-facing: Steps 1 and 2

Be sure to follow the manufacturer's instructions for the proper use of your child restraint. Follow these steps to install a rear-facing child restraint on the rear outboard seats using ISOFIX:

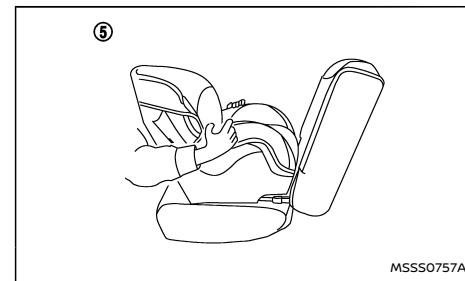
1. Position the child restraint on the seat ①.
2. Secure the child restraint anchor attachments to the ISOFIX lower anchors ②.



Rear-facing: Step 3

3. Shorten the rigid attachment to have the child restraint firmly tightened; press downward ③ and rearward ④ firmly in the centre of the child restraint with your hand to compress the vehicle seat cushion and seatback.
4. If the child restraint is equipped with a top tether strap, route the top tether strap and secure the tether strap to the tether anchor point. (See "Child restraint anchorage (for second row seats)" (P.50).)
5. If the child restraint is equipped with other anti-rotation devices such as support legs, use

them instead of the top tether strap following the child restraint manufacturer's instructions.



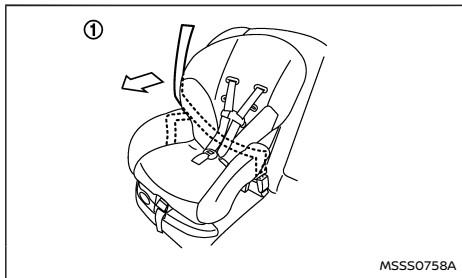
Rear-facing: Step 6

6. Test the child restraint before you place the child in it ⑤. Push the child restraint from side to side and tug it forward to make sure that it is held securely in place.
7. Check to make sure that the child restraint is properly secured prior to each use. If the child restraint is loose, repeat steps 3 through 6.

CHILD RESTRAINT INSTALLATION USING THREE-POINT TYPE SEAT BELT

Installation on rear seats

If you install a child restraint on the third row seat, slide the second row seat to the frontmost position (Three row model).

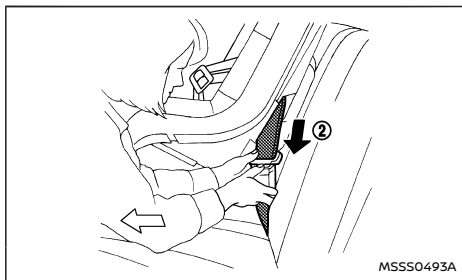
Front-facing:

MSSS0758A

Front-facing: Step 1

Be sure to follow the manufacturer's instructions for the proper use of your child restraint. Follow these steps to install a front-facing child restraint on the rear seats using three-point type seat belt without automatic locking mode:

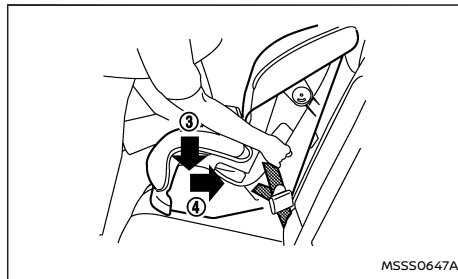
1. Position the child restraint on the seat ①.



MSSS0493A

Front-facing: Step 2

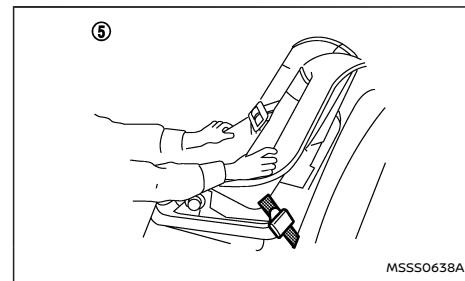
2. Route the seat belt tongue through the child restraint and insert it into the buckle ② until you hear and feel the latch engage.
3. To prevent slack in the seat belt webbing, it is necessary to secure the seat belt in place with locking devices attached to the child restraint.



MSSS0647A

Front-facing: Step 4

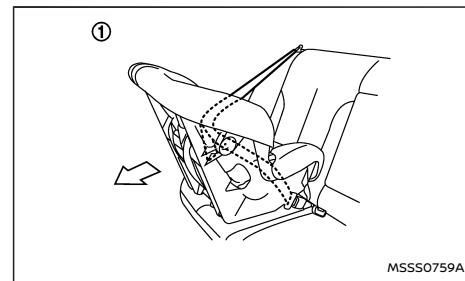
4. Remove any additional slack from the seat belt; press downward ③ and rearward ④ firmly in the centre of the child restraint with your knee to compress the vehicle seat cushion and seatback while pulling up on the seat belt. Adjustable seatbacks should be positioned to ensure full contact between child restraint and seatback.



MSSS0638A

Front-facing: Step 5

5. Test the child restraint before you place the child in it ⑤. Push the child restraint from side to side and tug it forward to make sure that it is held securely in place.
6. Check to make sure that the child restraint is properly secured prior to each use. If the child restraint is loose, repeat steps 3 through 5.

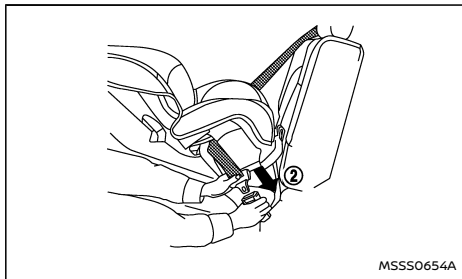
Rear-facing:

MSSS0759A

Rear-facing: Step 1

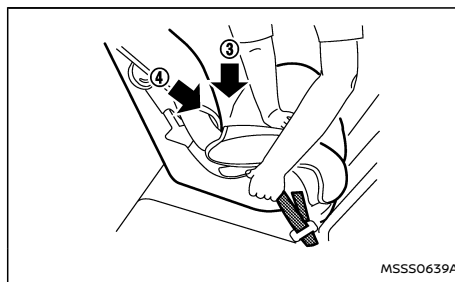
Be sure to follow the manufacturer's instructions for the proper use of your child restraint. Follow these steps to install a rear-facing child restraint on the rear seats using three-point type seat belt without automatic locking mode:

1. Position the child restraint on the seat ①.



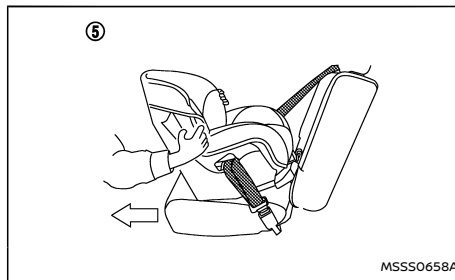
Rear-facing: Step 2

2. Route the seat belt tongue through the child restraint and insert it into the buckle ② until you hear and feel the latch engage.
3. To prevent slack in the seat belt webbing, it is necessary to secure the seat belt in place with locking devices attached to the child restraint.



Rear-facing: Step 4

4. Remove any additional slack from the seat belt; press downward ③ and rearward ④ firmly in the centre of the child restraint with your hand to compress the vehicle seat cushion and seatback while pulling up on the seat belt.



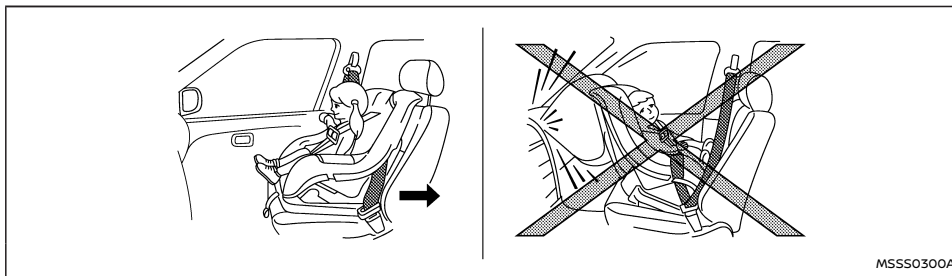
Rear-facing: Step 5

5. Test the child restraint before you place the child in it ⑤. Push the child restraint from side


to side and tug it forward to make sure that it is held securely in place.

6. Check to make sure that the child restraint is properly secured prior to each use. If the child restraint is loose, repeat steps 3 through 5.

Installation on front passenger's seat



⚠ WARNING

- Never install a rear-facing child restraint on the front passenger seat without ensuring that the front passenger air bag is deactivated. The vehicle is equipped with an automatic front-passenger front air bag deactivation system. The <PASSENGER AIR BAG OFF> indicator light , located on the roof console, must be lit. In a frontal collision, supplemental front-impact air bags inflate with great force. An inflating supplemental front-impact air bag could seriously injure or kill your child.
- Never install a child restraint with a top tether strap on the front seat.
- NISSAN recommends that a child restraint be installed on the rear seat. However, if you must install a child restraint on the

front passenger's seat, move the passenger's seat to the rearmost position.

- Child restraints for infants must be used in the rear-facing direction and therefore must not be used on the front passenger's seat when the front passenger's air bag is available.
- Failure to use the seat belts will result in the child restraint not being properly secured. It could tip over or otherwise be unsecured and cause injury to the child in a sudden stop or collision.

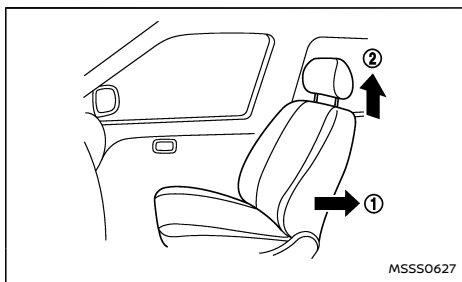
Front-facing:

Be sure to follow the manufacturer's instructions for the proper use of your child restraint. Follow these steps to install a front-facing child restraint on the front passenger's seat using a three-point type seat belt.

If the child restraint is installed on the front passenger seat, place the power switch in the ON position. The front passenger air bag status light <PASSENGER AIR BAG OFF>, located on the roof console, should illuminate. If this light is not illuminated, see "Supplemental Restraint System (SRS)" (P.57). Move the child restraint to another seating position. Have the system checked by a NISSAN dealer or qualified workshop.



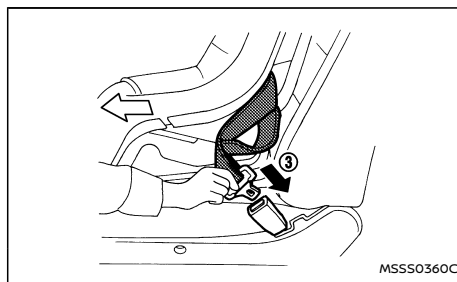
Front passenger air bag status light <OFF> (where fitted)



Front-facing: Steps 1 and 2

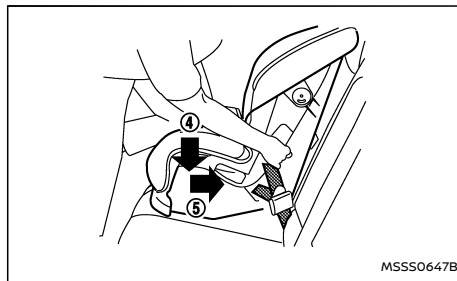
1. Move the seat to the rearmost position ①.
2. Adjust or remove the head restraint ② to obtain the correct child restraint fit.
3. Adjust the seat lifter (where fitted) to the uppermost position.
4. Position the child restraint in the seat.

Always follow the child restraint system manufacturer's instructions for installation and use.



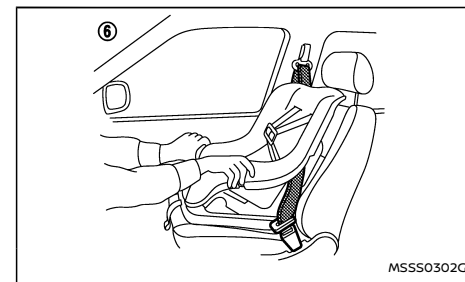
Front-facing: Step 5

5. Route the seat belt tongue through the child restraint and insert it into the buckle ③ until you hear and feel the latch engage.
6. To prevent slack in the seat belt webbing, it is necessary to secure the seat belt in place with locking devices attached to the child restraint.



Front-facing: Step 7

7. Remove any additional slack from the seat belt; press downward ④ and rearward ⑤ firmly in the centre of the child restraint with your knee and seatback while pulling up on the seat belt.




Front-facing: Step 8

8. Test the child restraint before you place the child in it ⑥. Push the child restraint from side to side and tug it forward to make sure that it is held securely in place.
9. Check to make sure that the child restraint is properly secured prior to each use. If the child restraint is loose, repeat steps 6 through 8.

If the child restraint is still loose, do not use it. Please check the child restraint system manufacturer's instructions for installation and use. Seek advice from a NISSAN dealer or qualified workshop.

10. Place the power switch in the ON position. Check the front passenger air bag status light located on the roof console. The front pas-

SUPPLEMENTAL RESTRAINT SYSTEM (SRS)

Passenger air bag status light  (OFF) should illuminate.

PRECAUTIONS ON SUPPLEMENTAL RESTRAINT SYSTEM (SRS)

This Supplemental Restraint System (SRS) section contains important information concerning the driver's and passenger's supplemental front-impact air bags, supplemental side-impact air bags, supplemental front central side-impact air bag, supplemental curtain side-impact air bags and pre-tensioner seat belts.

Supplemental front-impact air bag system

This system can help cushion the impact force to the head and chest areas of the driver and/or front passenger in certain frontal collisions. The supplemental front-impact air bag is designed to inflate on the front where the vehicle is impacted.

Supplemental side-impact air bag system

This system can help cushion the impact force to the chest and pelvis areas of the driver and front passenger in certain side-impact collisions. The supplemental side-impact air bag is designed to inflate on the side where the vehicle is impacted.

Supplemental front central side-impact air bag system

This system can help cushion the impact force to the head area of the driver and front passenger in certain side impact collisions.

The front central side-impact air bag is designed to inflate in the front central area where the vehicle is impacted.

Supplemental curtain side-impact air bag system

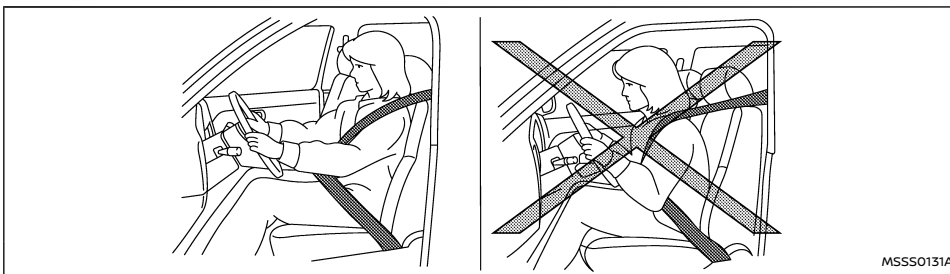
This system can help cushion the impact force to the head of the driver and passengers in front and rear outboard seating positions in certain side-impact collisions. The supplemental curtain side-impact air bag is designed to inflate on the side where the vehicle is impacted.

The SRS is designed to **supplement** the accident protection provided by the seat belts and **is not** designed to **substitute** for them. The SRS can help save lives and reduce serious injuries. However, inflating air bags may cause abrasions or other injuries. Air bags do not provide protection to the lower body. Seat belts should always be correctly worn and the occupants should always be seated a suitable distance away from the steering wheel, instrument panel and door finishers. (See "Seat belts" (P.38).) The air bags inflate quickly in order to help protect the occupants. The force of the air bags inflating can increase the risk of injury if the occupants are too close to, or are against, the air bag modules during inflation.

The front and side-impact air bags will deflate quickly after deployment. The front central side-impact air bag and curtain side-impact air bags will remain inflated for a short period of time.

The SRS operates only when the power switch is in the ON position.

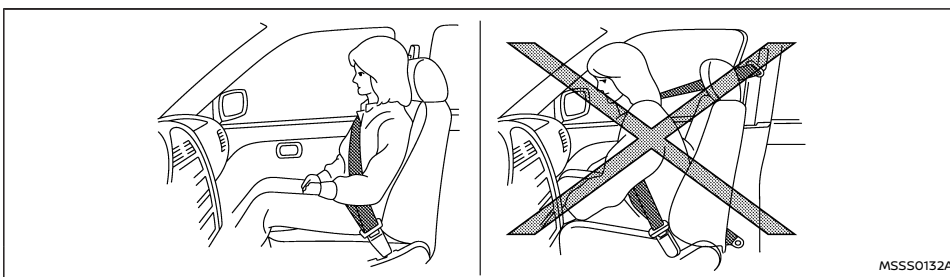
When the power switch is in the ON position, the SRS air bag warning light illuminates for about 7 seconds and then turns off. This indicates that the SRS is operational. (See "SRS air bag warning light" (P.61).)



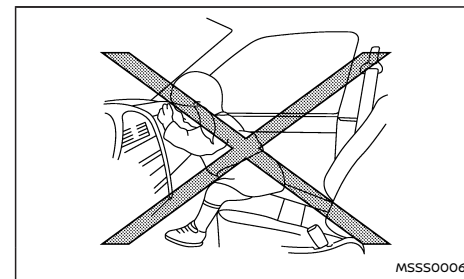
MSS50131A

it when it inflates. Always sit back against the seatback and as far away as practical from the steering wheel or instrument panel. Always use the seat belts.

- Keep hands on the outside of the steering wheel. Placing them inside the steering wheel rim could increase the risk of injury if the supplemental front air bag inflates.



MSS50132A

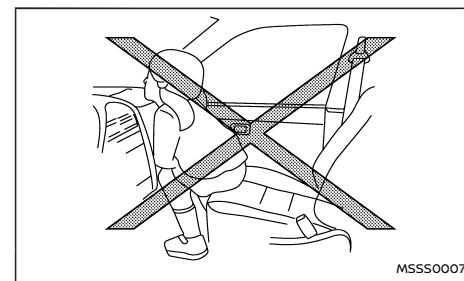


MSS50006

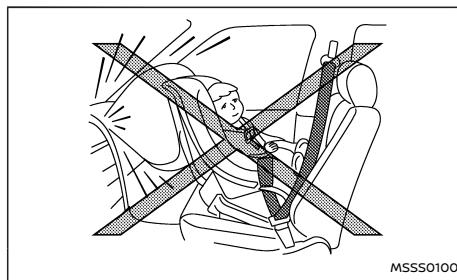
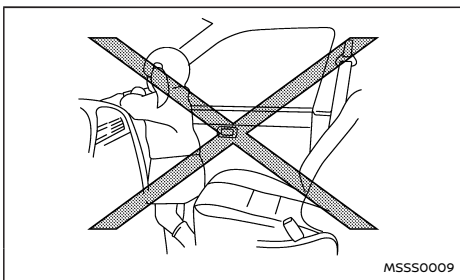
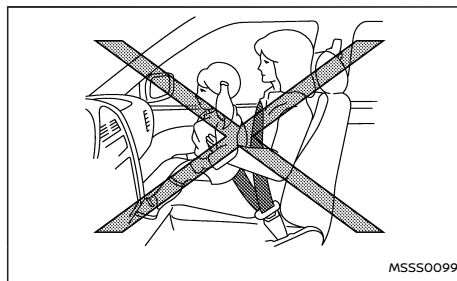
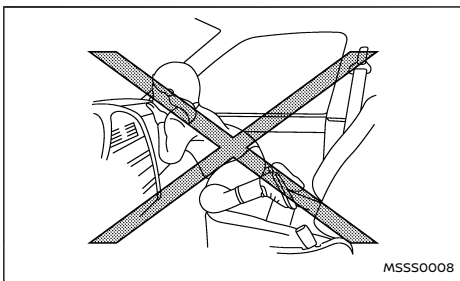
⚠ WARNING

- The supplemental front air bags ordinarily will not inflate in the event of a side impact, rear impact, rollover, or lower severity frontal collision. Always wear your seat belts to help reduce the risk or severity of injury in various kinds of accidents.
- The seat belts and the supplemental front-impact air bags are most effective when

you are sitting well back and upright in the seat. The front-impact air bags inflate with great force. If you and your passengers are unrestrained, leaning forward, sitting sideways, or out of position in any way, you and your passengers are at greater risk of injury or death in an accident. You and your passengers may also receive serious or fatal injuries from the supplemental front-impact air bag if you are up against

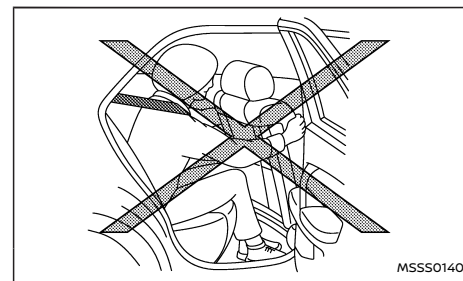
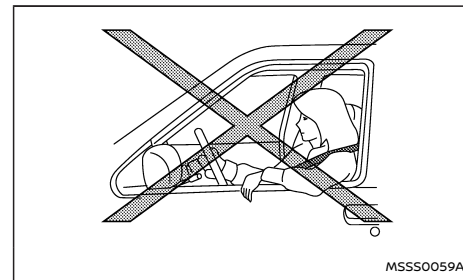


MSS50007



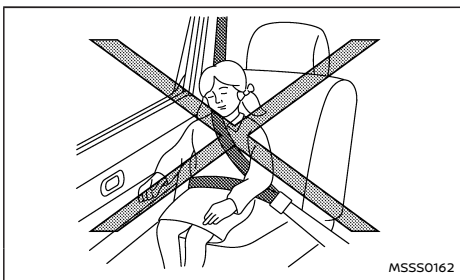
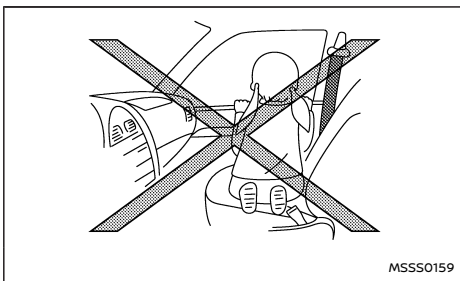
when the air bags inflate if they are not properly restrained.

- Never install a rear-facing child restraint system on the front passenger seat without ensuring that the front passenger air bag is deactivated. An inflating supplemental front-impact air bag could seriously injure or kill your child. (See "Child restraints" (P.43).)



⚠ WARNING

- Never let children ride unrestrained or extend their hands or face out of the window. Do not attempt to hold them in your lap or arms. Some examples of dangerous riding positions are shown in the illustrations.
- Children may be severely injured or killed



⚠ WARNING

- The supplemental front central side-impact air bag, supplemental side-impact air bags and supplemental curtain side-impact air bags ordinarily will not inflate in the event of a front impact, rear impact, rollover, or lower severity side collision. Always wear the seat belts to help reduce the risk or severity of injury in accidents.

- The seat belts and the supplemental front central side-impact air bag, supplemental side-impact air bags and supplemental curtain side-impact air bags are most effective when you are sitting well back and upright in the seat. The supplemental front central side-impact air bag, supplemental side-impact air bags and supplemental curtain side-impact air bags inflate with great force. If you and your passengers are unrestrained, leaning forward, sitting sideways, or out of position in any way, you and your passengers are at greater risk of injury or death in an accident.

- Do not allow anyone to place their hands, legs or face near the supplemental front central side-impact air bag, supplemental side-impact air bags, supplemental curtain side-impact air bags located on the centre of the seatback of the driver's seat, the sides of the seatback of the front seats or near the side roof rails. Do not allow anyone sitting in the front seats or rear outboard seats to extend their hands out of the windows or lean against the doors. Some examples of dangerous riding positions are shown in the illustrations.

- When sitting in the rear seats, do not hold onto the seatback of the front seats. If the supplemental front central side-impact air bag, supplemental side-impact air bags and supplemental curtain side-impact air bags inflate, you may be seriously injured.

Be especially careful with children, who should always be properly restrained.

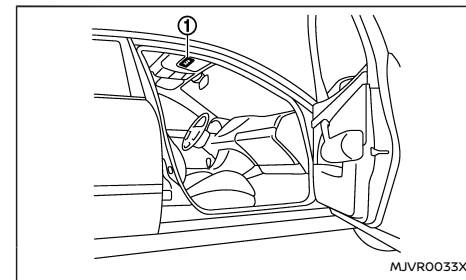
- Do not use non-genuine seat covers on the front seatbacks. They may interfere with the supplemental front central side-impact air bag and supplemental side-impact air bag inflations.

Pre-tensioner seat belt system

The pre-tensioner seat belt system may activate with the supplemental air bag system in certain types of collisions.

Working with the seat belt retractors and front lap outer anchors, it helps tighten the seat belt the instant the vehicle becomes involved in certain types of collisions, helping to restrain front and second row outboard seat occupants. (See "Pre-tensioner seat belt system" (P.68).)

Air bag warning labels



Warning labels about the supplemental air bag system are placed in the vehicle as shown in the illustration.

The warning label ① is located on the surface of the front passenger's sun visor.



The label warns:


“NEVER use a rearward facing child restraint on a seat protected by an ACTIVE AIR BAG in front of it, DEATH or SERIOUS INJURY to the CHILD can occur.”

In vehicles equipped with a front-impact passenger air bag system, use a rear-facing child restraint system only on the rear seats.

When installing a child restraint system in your vehicle, always follow the child restraint system manufacturer's instructions for installation. For additional information, see “Child restraints” (P.43).

SRS air bag warning light



The supplemental air bag warning light, displaying  in the meter monitors the circuits for the air bag systems, pre-tensioner seat belt system and all related wiring.

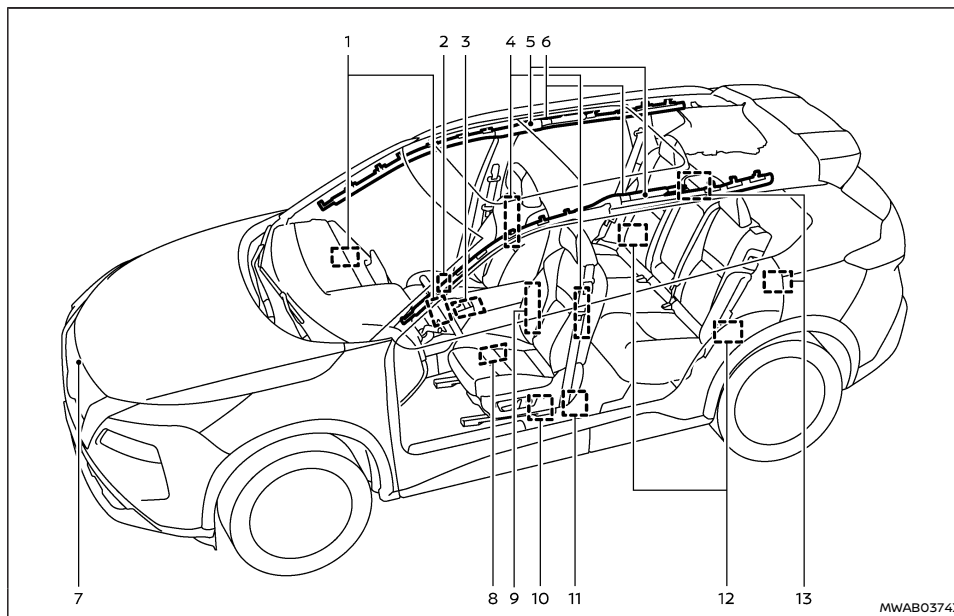
When the power switch is in the ON position, the SRS air bag warning light illuminates for about 7 seconds and then turns off. This indicates that the SRS air bag systems are operational.

If any of the following conditions occur, the air bag and/or pre-tensioner seat belt systems need servicing:

- The SRS air bag warning light remains on after approximately 7 seconds.
- The SRS air bag warning light does not illuminate at all.

Under these conditions, the air bag, pre-tensioner seat belt and/or occupant classification sensor systems may not operate properly. They must be checked and repaired. Contact a NISSAN dealer or qualified workshop immediately.

SUPPLEMENTAL AIR BAG SYSTEMS



Example (Two row model shown)

- | | |
|--|---|
| 1. Supplemental front-impact air bag modules | 4. Supplemental side-impact air bag modules |
| 2. Occupant classification sensor (front passenger's seat) | 5. Supplemental curtain side-impact air bag inflators |
| 3. Air bag Control Unit (ACU) | 6. Supplemental curtain side-impact air bag modules |

7. Crash zone sensor
8. Front door pressure sensor (left-side shown; right-side similar)
9. Supplemental front central side-impact air bag modules (driver's seat)
10. Lap outer pre-tensioners (front)
11. Seat belt pre-tensioner retractors (front)
12. Satellite sensors (rear)
13. Seat belt pre-tensioner retractors (second row outboard seats)

⚠ WARNING

- Do not place any objects on the steering wheel pad, on the instrument panel, and near the front door finishers and the front seats. Do not place any objects between any occupants and the steering wheel pad, on the instrument panel, and near the front door finishers and the front seats. Such objects may become dangerous projectiles and cause injury if a supplemental air bag inflates.
- Immediately after inflation, several supplemental air bag system components will be hot. Do not touch them: you may severely burn yourself.
- No unauthorised changes should be made to any components or wiring of the supplemental air bag systems. This is to prevent accidental inflation of the supplemental air bags or damage to the supplemental air bag systems.
- Do not make unauthorised changes to

your vehicle's electrical system, suspension system, front end structure and side panels. This could affect proper operation of the supplemental air bag systems.

- Tampering with the supplemental air bag systems may result in serious personal injury. Tampering includes changes to the steering wheel and the instrument panel by placing materials over the steering wheel pad and above, around or on the instrument panel or by installing additional trim materials around the supplemental air bag systems.
- Work on and around the supplemental air bag systems should be done by a NISSAN dealer or qualified workshop. The SRS wiring should not be modified or disconnected. Unauthorised electrical test equipment and probing devices should not be used on the supplemental air bag systems.
- The SRS wiring harness connectors are yellow and/or orange for easy identification.

When the air bags inflate, a fairly loud noise may be heard, followed by the release of smoke. This smoke is not harmful and does not indicate a fire. Care should be taken not to inhale it, as it may cause irritation and choking. Those with a history of a breathing condition should get fresh air promptly.

Supplemental front-impact air bag system

The driver's supplemental front-impact air bag is located at the centre of the steering wheel. The passenger's supplemental front-impact air bag is located at the instrument panel above the glove box.

The supplemental front-impact air bag system is designed to inflate in higher severity frontal collisions, although it may inflate if the forces in another type of collision are similar to those of a higher severity frontal impact. It may not inflate in certain frontal collisions. Vehicle damage (or lack of it) is not always an indication of proper supplemental front-impact air bag system operation.

Front passenger air bag status light (where fitted):




OFF light







ON light

⚠ WARNING

Never install a rear-facing child restraint system on the front passenger seat without ensuring that the front passenger air bag is deactivated. The vehicle is equipped with an automatic front-passenger front air bag deactivation system. The <PASSENGER AIR BAG OFF> indicator  must be lit. In a frontal collision, supplemental front impact air bags inflate with great force. An inflating supplemental front-impact air bag could seriously injure or kill your child.






The front passenger seat is equipped with occupant classification sensor that turns the front passenger air bag on or off depending on the type of occupant or object detected on the front passenger seat. The status of the front passenger air bag (ON or OFF) is indicated by the front passenger air bag status lights <PASSENGER AIR


BAG OFF>  and <PASSENGER AIR BAG ON>  which are located on the roof console.

After the power switch is placed in the ON position, the <PASSENGER AIR BAG OFF>  and <PASSENGER AIR BAG ON>  indicator lights must light up simultaneously for approximately 7 seconds.

The indicator lights display the status of the front passenger front air bag:

- <PASSENGER AIR BAG ON> lights up: the front passenger front air bag is enabled. If, in the event of an accident, all deployment criteria are met, the front passenger front air bag is deployed.
- <PASSENGER AIR BAG OFF> lights up: the front passenger front air bag is disabled. It will then not be deployed in the event of an accident.

CONDITION	DESCRIPTION	PASSENGER AIR BAG INDICATOR LIGHT  OR 	FRONT PASSENGER AIR BAG STATUS
Empty	Empty front passenger seat	 illuminated	INHIBITED
Nissan recommended child restraint with child	Bag or Child Restraint in front passenger seat*	 illuminated	INHIBITED
Adult	Adult in the front passenger seat	 illuminated	ACTIVATED

* If an approved child restraint system is not being used, the passenger air bag may be active ( illuminated).

In addition to the above, certain objects placed on the front passenger seat may also cause the light to operate as described above.


For additional information related to the normal operation and troubleshooting of this occupant

classification sensor system, please refer to “Troubleshooting” later in this section.

Automatic front-passenger air bag deactivation system:

WARNING

The front passenger air bag is designed to automatically turn OFF under some conditions. Read this section carefully to learn how it operates. Proper use of the seat, seat belt and child restraints is necessary for most effective protection. Failure to follow all instructions in this manual concerning the use of seats, seat belts and child restraints can increase the risk or severity of injury in an accident.

In order to recognise a child restraint system on the front-passenger seat, the automatic front-passenger front air bag deactivation system categorizes the person in the front passenger seat using an occupant classification sensor. Depending on that result, the front-passenger front air bag is either enabled or disabled. If a NISSAN recommended child restraint system is fitted to the front passenger seat, the <PASSENGER AIR BAG OFF>  indicator light must light up after the system self-test and remain lit. The front passenger front air bag is disabled.

The occupant classification sensor in this vehicle is designed to detect the type of occupant or objects on the seat. For example, if an approved child restraint on the seat, it can be detected together with the child and cause the air bag to turn OFF. Front passenger seat adult occupants who are


properly seated and using the seat belt as outlined in this manual should automatically cause the passenger air bag to be turned ON. However, if the occupant is not sitting correctly on the seat cushion (for example, by not sitting upright, by sitting on an edge of the seat, or by otherwise being out of position), this could cause the sensor to turn the air bag OFF. Always be sure to be seated and wearing the seat belt properly for the most effective protection by the seat belt and supplemental air bag.




NISSAN recommends that pre-teens and children be properly restrained in a rear seat. NISSAN also recommends that appropriate child restraints and booster seats be properly installed in a rear seat. If this is not possible, the occupant classification sensor is designed to operate as described above to turn the front passenger air bag OFF for NISSAN recommended child restraints. Failing to properly secure child restraints may allow the restraint to tip or move in an accident or sudden stop. This can also result in the passenger air bag inflating in a crash instead of being OFF. (See "Child restraints" later in this section for proper use and installation.)


If the front passenger seat is not occupied, the passenger air bag are designed not to inflate in a crash. However, heavy objects placed on the seat could result in air bag inflation, because of the way the object is detected by the occupant classification sensor. Other conditions could also result in air bag inflation, such as if a child is standing on the seat, or if two children are on the seat, if the seat is wet, or if an electrical device is on the seat, contrary to the instructions in this manual. Always

be sure that you and all vehicle occupants are seated and restrained properly.

Using the front passenger air bag status light, you can monitor when the front passenger air bag is automatically turned OFF.


If an adult occupant is in the seat but the <PASSENGER AIR BAG OFF>  indicator light is illuminated (indicating that the front passenger air bag is OFF), it could be that the person is not sitting on the seat properly. If a non-genuine seat cover or additional cushion is used, this may also prevent the occupant classification sensor from detecting an adult correctly.

If a child restraint must be used in the front seat, the <PASSENGER AIR BAG OFF>  indicator light may or may not be illuminated, depending on the size of the child and the type of child restraint being used. If the <PASSENGER AIR BAG OFF>  light is not illuminated (indicating that the air bag might inflate in a crash), it could be that the child restraint or seat belt is not being used properly. Make sure that the child restraint is installed properly, the seat belt is used properly and the occupant is positioned properly. If the <PASSENGER AIR BAG OFF>  light is not illuminated, reposition the occupant or child restraint in a rear seat.

If the <PASSENGER AIR BAG OFF>  light will not illuminate even though you believe that the child restraint, the seat belts and the occupant are properly positioned, it is recommended that you take your vehicle to a NISSAN dealer or qualified workshop. A NISSAN dealer or qualified workshop can check the system status by using a special

tool. However, until you have confirmed with your dealer that your air bag is working properly, reposition the occupant or child restraint in a rear seat.

The air bag system and front passenger air bag status lights will take a few seconds to register a change in the passenger seat status. This is normal system operation and does not indicate a malfunction.

If a malfunction occurs in the front passenger air bag system, the supplemental air bag warning light , located in the meters and gauges area, will illuminate (blinking or steadily lit). Also, if the seat is wet and the system cannot work correctly, the system will deactivate the passenger air bag temporarily and illuminate the supplemental air bag warning light until seat is dry. Have the system checked. It is recommended you visit a NISSAN dealer or qualified workshop for this service.

Normal operation:

In order for the occupant classification sensor system to classify the front passenger, please follow the precautions and steps outlined below:

Precautions:

- Make sure that a child restraint or other object is not pressing against the rear of the seat-back.
- Make sure that a rear passenger is not pushing or pulling on the back of the front passenger seat.
- Make sure that the front passenger seat or seatback is not forced back against an object on the seat or floor behind it.

- Make sure that there is no object placed under the front passenger seat.
- Make sure that the front passenger seat head restraint does not contact the roof when adjusting the front passenger seat.
- Make sure the seat is dry.
- Make sure no electrical devices are placed on the seat.
- Make sure additional non-genuine seat covers or cushions are not used on the front passenger seat.
- Make sure the occupant of the seat is not wearing heavily padded clothing items.


Steps:

1. Adjust the seat as outlined. (See “Seats” earlier in this section.) Sit upright, leaning against the seatback, and centered on the seat cushion with your feet comfortably extended to the floor.
2. Make sure there are no objects on your lap.
3. Fasten the seat belt as outlined. (See “Seat belts” earlier in this section.) Front passenger seat belt buckle status is monitored by the occupant classification system, and is used as an input to determine occupancy status. So, it is highly recommended that the front passenger fastens their seat belt.
4. Remain in this position for several seconds allowing the system to classify the front passenger before the vehicle is put into motion.
5. Ensure proper classification by checking the front passenger air bag status light.

NOTE:

This vehicle’s occupant classification sensor system generally keeps the classification locked during driving, so it is important that you confirm that the front passenger is properly classified prior to driving. However, the occupant classification sensor system may recalculate the classification of the occupant under some conditions (both while driving and when stopped), so the front passenger seat occupant should continue to remain seated as outlined above.



WARNING

If the <PASSENGER AIR BAG OFF>  indicator light is lit, the front-passenger front air bag is disabled. It will not be deployed in the event of an accident and cannot perform its intended protective function. A person in the front passenger seat could then, for example, come into contact with the vehicle’s interior, especially if the person is sitting too close to the dashboard. This poses an increased risk of injury or even fatal injury.

When the front-passenger seat is occupied, always make sure that:


- The classification of the person in the front passenger seat is correct and that the front passenger front air bag is enabled or disabled in accordance with the person in the front passenger seat.
- The front-passenger seat has been moved back as far back as possible.
- The person is seated correctly.

If you secure a child on the front passenger

seat in a rearward-facing child restraint system and the <PASSENGER AIR BAG ON>  indicator lights up, the passenger’s air bag could be deployed in the event of an accident. The child could be struck by the air bag. There is an increased risk of injury, possibly even fatal. In this case, always ensure that the passenger’s air bag is disabled. The <PASSENGER AIR BAG OFF>  indicator must light up.

Troubleshooting:

If you think the front passenger air bag status light is incorrect:

1. If the <PASSENGER AIR BAG OFF>  light is lit with an adult occupying the front passenger seat:

This may be due to the following conditions that may be interfering with the occupant classification sensor:


- Occupant is not sitting upright, leaning against the seatback, and centered on the seat cushion with his/her feet comfortably extended to the floor.
- A child restraint or other object pressing against the rear of the seatback.
- A rear passenger pushing or pulling on the back of the front passenger seat.
- Forcing the front seat or seatback against an object on the seat or floor behind it.
- An object placed under the front passenger seat.
- An object placed between the seat cushion and centre console or between the seat cushion and the door.


- The seat is wet or damp.
- An electrical device like a smartphone or tablet PC is placed on the seat.
- Non-genuine seat covers or cushions are used on the front passenger seat
- The occupant of the seat is wearing heavily padded clothing items.

If the vehicle is moving, please come to a stop when it is safe to do so. Check and correct any of the above conditions. Restart the vehicle.

NOTE:

A system check will be performed during which the front passenger air bag status lights will remain lit for about 7 seconds initially.

If the <PASSENGER AIR BAG OFF>  light is still lit after this, the person should be advised not to ride in the front passenger seat and the vehicle should be checked as soon as possible. It is recommended you visit a NISSAN dealer or qualified workshop for this service.

2. If the <PASSENGER AIR BAG ON>  light is lit with a child restraint occupying the front passenger seat.

This may be due to the following conditions that may be interfering with the occupant classification sensor:


- The child restraint is not properly installed, as outlined. (See “Child restraints” (P.43).)
- A child restraint or other object pressing against the rear of the seatback.
- A rear passenger pushing or pulling on the back of the front passenger seat.


- Forcing the front seat or seatback against an object on the seat or floor behind it.
- An object placed under the front passenger seat.
- An object placed between the seat cushion and centre console or between the seat cushion and the door.
- The seat is wet or damp.
- An electrical device like a smartphone or tablet PC is placed on the seat.
- The front passenger seat head restraint contacting the roof.

If the vehicle is moving, please come to a stop when it is safe to do so. Check and correct any of the above conditions. Restart the vehicle.

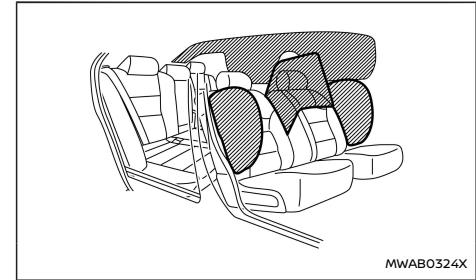
NOTE:

A system check will be performed during which the front passenger air bag status light will remain lit for about 7 seconds initially.

If the <PASSENGER AIR BAG ON>  light is still lit after this, the child restraint should be repositioned in the rear seat and it is recommended that the vehicle should be checked by a NISSAN dealer or qualified workshop as soon as possible.

3. If the <PASSENGER AIR BAG ON>  light is lit with no front passenger and no objects on the front passenger seat, the vehicle should be checked as soon as possible. It is recommended you visit a NISSAN dealer or qualified workshop for this service.

Supplemental side-impact air bag system



The supplemental side-impact air bag is located at the outside of the front seats' seatbacks.

The supplemental side-impact air bag system is designed to inflate in higher severity side collisions, although it may inflate if the forces in another type of collision are similar to those of a higher severity side impact. It may not inflate in certain side collisions. Vehicle damage (or lack of it) is not always an indication of proper supplemental side-impact air bag system operation.

Supplemental front central side-impact air bag system

The supplemental front central side-impact air bag is located at the inside of the driver's seats' seatback.

The supplemental front central side-impact air bag system is designed to inflate in higher severity side collisions, although it may inflate if the forces in another type of collision are similar to those of a higher severity side impact. It may not inflate in

certain side collisions. Vehicle damage (or lack of it) is not always an indication of proper supplemental front central side-impact air bag system operation.

Supplemental curtain side-impact air bag system
The supplemental curtain side-impact air bag is located at the roof rails.

The supplemental curtain side-impact air bag system is designed to inflate in higher severity side collisions, although it may inflate if the forces in another type of collision are similar to those of a higher severity side impact. It may not inflate in certain side collisions. Vehicle damage (or lack of it) is not always an indication of proper supplemental curtain side-impact air bag system operation.

PRE-TENSIONER SEAT BELT SYSTEM

WARNING

- **The pre-tensioner seat belt cannot be reused after activation. It must be replaced together with the retractor and buckle as a unit.**
- **If the vehicle becomes involved in a collision but the pre-tensioner is not activated, be sure to have the pre-tensioner system checked and, if necessary, replaced by a NISSAN dealer or qualified workshop.**
- **No unauthorised changes should be made to any components or wiring of the pre-tensioner seat belt system. This is to prevent accidental activation of the pre-tensioner seat belt or damage to the pre-tensioner seat belt system.**

- **Work around or on the pre-tensioner seat belt system should be done by a NISSAN dealer or qualified workshop. The SRS wiring should not be modified or disconnected. Unauthorised electrical test equipment and probing devices should not be used on the pre-tensioner seat belt system.**
- **If you need to dispose of the pre-tensioner seat belt system, or scrap the vehicle, contact a NISSAN dealer or qualified workshop. Correct pre-tensioner disposal procedures are set forth in the appropriate NISSAN Service Manual. Incorrect disposal procedures could cause personal injury.**

The pre-tensioner seat belt system may activate with the supplemental air bag system in certain types of collisions.

Working with the seat belt retractor, it helps tighten the seat belt when the vehicle becomes involved in certain types of collisions, helping to restrain the occupants.

The pre-tensioner is encased with the front and second row outboard seat belt's retractor and anchor. These seat belts are used the same as conventional seat belts.

When the pre-tensioner seat belt activates, a fairly loud noise may be heard, followed by the release of smoke. This smoke is not harmful and does not indicate a fire. Care should be taken not to inhale it, as it may cause irritation and choking. Those with a history of a breathing condition should get fresh air promptly.

REPAIR AND REPLACEMENT PROCEDURE

WARNING

- **Once the air bags have been inflated, the air bag modules will not function and must be replaced. The air bag modules must be replaced by a NISSAN dealer or qualified workshop. The inflated air bag modules cannot be repaired.**
- **The air bag systems should be inspected by a NISSAN dealer or qualified workshop if there is any damage to the front end or side portion of the vehicle.**
- **If you need to dispose of the SRS or scrap the vehicle, contact a NISSAN dealer or qualified workshop. Correct disposal procedures are set forth in the appropriate NISSAN Service Manual. Incorrect disposal procedures could cause personal injury.**
- **If there is an impact to your vehicle from any direction, your occupant classification sensor should be checked to verify it is still functioning correctly. It is recommended that you visit a NISSAN dealer or qualified workshop for this service. The occupant classification sensor should be checked even if no air bags deploy as a result of the impact. Failure to verify proper occupant classification sensor function may result in an improper air bag deployment resulting in injury or death.**

The air bags and pre-tensioner seat belts are designed to activate on a one-time-only basis. As a

reminder, unless the SRS air bag warning light is damaged, the SRS air bag warning light remains illuminated after inflation has occurred. The repair and replacement of the SRS should be done only by a NISSAN dealer or qualified workshop.

When maintenance work is required on the vehicle, information about the air bags, pre-tensioner seat belts and related parts should be pointed out to the person performing the maintenance. The power switch should always be in the OFF position when working under the bonnet or inside the vehicle.

MEMO

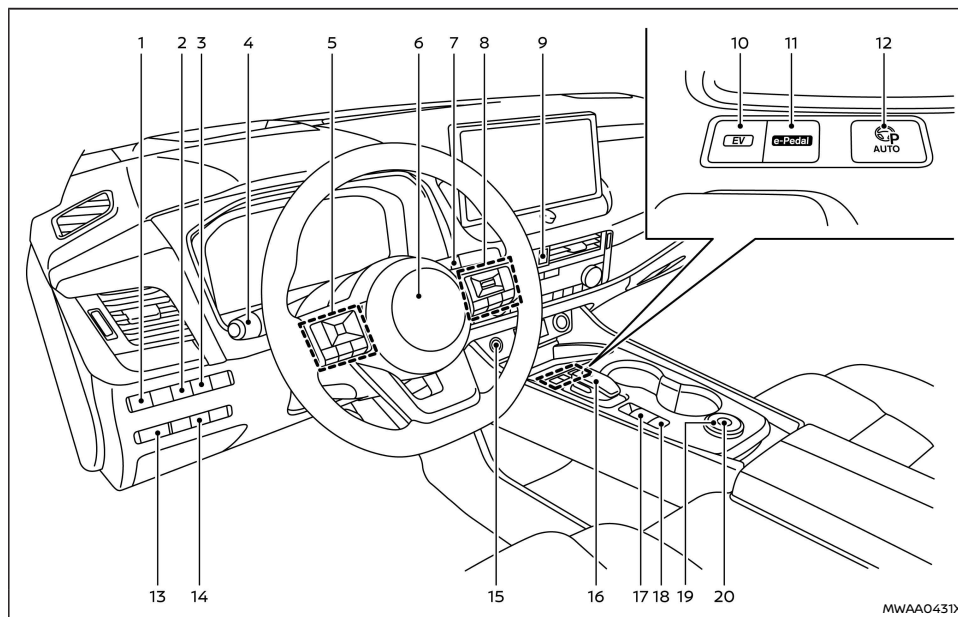
2 Instruments and controls

Cockpit	73	How to use the vehicle information display	92
Left-Hand Drive (LHD) model	73	Shortcut Menu	92
Right-Hand Drive (RHD) model	74	Startup display	93
Instrument panel	76	Settings	93
Left-Hand Drive (LHD) model	76	Vehicle information display warnings and indicators	101
Right-Hand Drive (RHD) model	77	Trip computer	113
Meters and gauges	78	Clock and outside air temperature	117
Models with full-screen display	78	Head Up Display (HUD) (where fitted)	118
Speedometer and odometer	79	How to use the HUD	119
Power meter	80	Driving Aids/Navigation/Traffic Sign/Audio/Telephone linking	119
Li-ion battery available charge gauge	80	Headlight and turn signal switch	120
Fuel gauge	81	Headlight switch	120
Instrument brightness control	81	Headlight cleaner (where fitted)	124
Shift position indicator	81	Headlight aiming control	125
e-Pedal indicator	81	Turn signal switch	128
ECO Drive Report	82	Fog light switch	128
Warning lights, indicator lights and audible reminders	83	Front fog lights (where fitted)	128
Checking lights	84	Rear fog light	129
Warning lights	84	Wiper and washer switch	129
Indicator lights	88	Windscreen wiper and washer operation	129
Audible reminders	91	Rain-sensing auto wiper system	130
Vehicle information display	92	Rear window wiper and washer operation	130
Changing the meter screen view (models with full-screen display)	92		

Heated windscreen (where fitted)	131	Tonneau cover	142
Defogger switch	132	Luggage hooks	142
Horn	132	Adjustable luggage floor (where fitted)	143
Heated steering wheel switch (where fitted)	133	LUGGAGE BOARD	145
Rear Door Alert (Where fitted)	133	Luggage under space (where fitted)	145
Power outlets	134	Roof rack (where fitted)	145
USB (Universal Serial Bus) charging connector (where fitted)	135	Windows	146
Wireless charger	135	Power windows	146
Emergency services call eCall/SOS system (where fitted)	137	Sunroof (where fitted)	148
Automatic eCall	137	Automatic sunroof and sunshade	148
Manual eCall (SOS button)	138	Sun visors	150
System status indicator	138	Assist grips	151
Modalities for exercising data subject's rights	139	Rear sunshade (where fitted)	151
Storage	139	Interior lights	151
Cup holders	139	Interior light switch	151
Soft bottle holders	140	Map lights	152
Glove box	140	Room lights (where fitted)	152
Console box	141	Rear personal lights (where fitted)	152
Lower console tray	141	Cargo light	152
Sunglasses holder	141	Vanity mirror lights	153
Card holder	141		
Coat hooks	142		

COCKPIT

LEFT-HAND DRIVE (LHD) MODEL



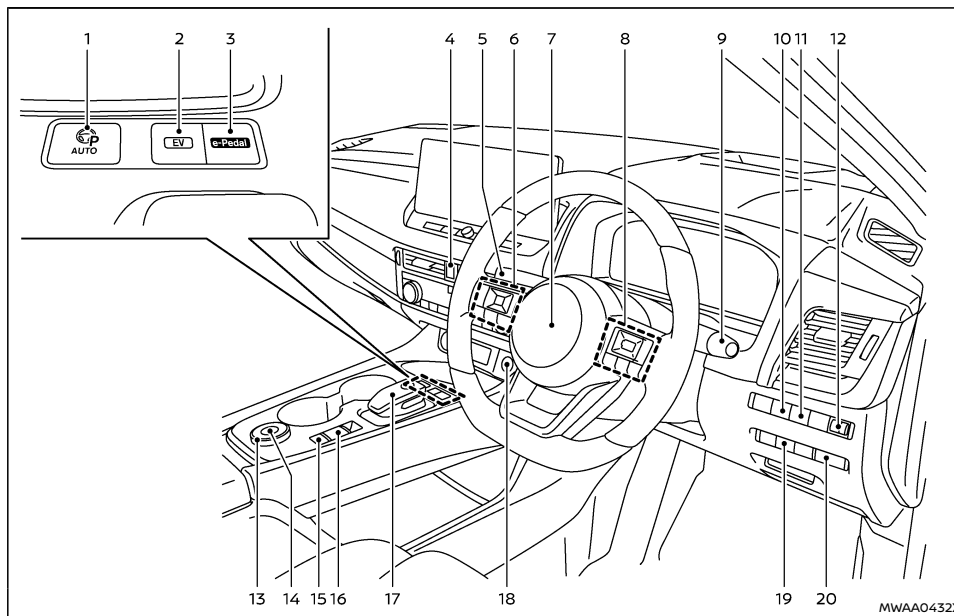
1. Headlight aiming control switch*
2. Steering Assist switch* (models with ProPILOT Assist system) or dynamic driver assistance switch* (models without ProPILOT Assist system)
3. Head Up Display (HUD) switch*
4. Headlight and turn signal switch/Fog light switch
5. Steering-wheel-mounted controls (left side)
 - Audio control
 - Vehicle information display control

6. Steering wheel
 - Horn
7. Wiper and washer switch
8. Steering-wheel-mounted controls (right side)
 - Speed limiter switches*
 - Cruise control switches*
 - Intelligent Cruise Control (ICC) switches*
 - ProPILOT Assist switches*
 - Bluetooth® Hands-Free Phone System switches
 - Voice Recognition system switch*
9. Hazard indicator flasher switch
10. EV mode switch
11. e-Pedal switch
12. ProPILOT Park switch*
13. Instrument brightness control
14. Power back door switch*
15. Push-button power switch
16. Shift lever
 - P position switch
17. Parking brake switch
18. Automatic brake hold switch
19. Drive Mode Selector**
20. Hill descent control switch*

*: where fitted

** : The Drive Mode Selector illustrated is for the 4WD model. On the 2WD model, the shape and location differ.

RIGHT-HAND DRIVE (RHD) MODEL



1. ProPILOT Park switch*
2. EV mode switch
3. e-Pedal switch
4. Hazard indicator flasher switch

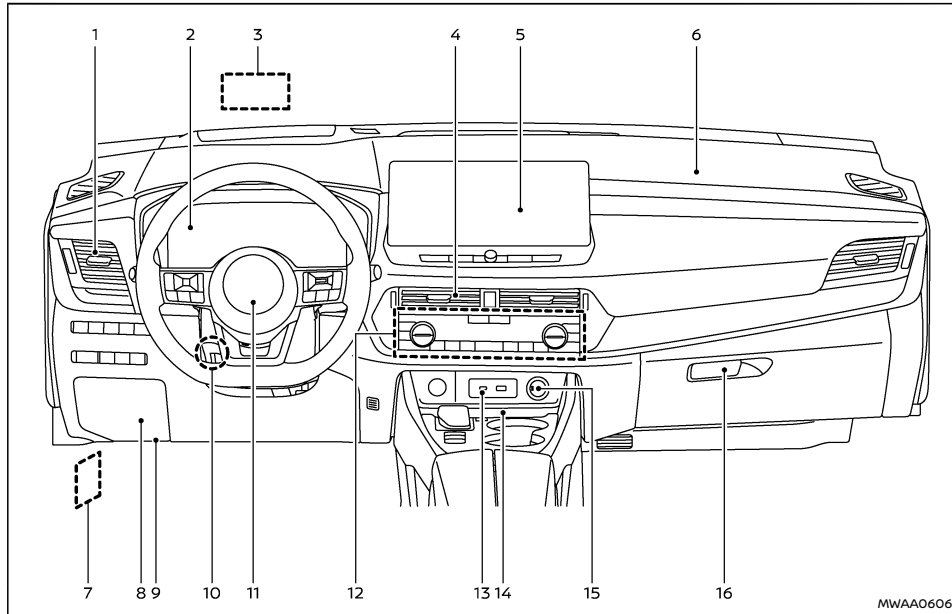
5. Headlight and turn signal switch/Fog light switch
6. Steering-wheel-mounted controls (left side)
 - Audio control
 - Vehicle information display control

7. Steering wheel
 - Horn
8. Steering-wheel-mounted controls (right side)
 - Speed limiter switches*
 - Cruise control switches*
 - Intelligent Cruise Control (ICC) switches*
 - ProPILOT Assist switches*
 - Bluetooth® Hands-Free Phone System switches
 - Voice Recognition system switch*
9. Wiper and washer switch
10. Head Up Display (HUD) switch*
11. Steering Assist switch* (models with ProPILOT Assist system) or dynamic driver assistance switch* (models without ProPILOT Assist system)
12. Headlight aiming control switch*
13. Drive Mode Selector**
14. Hill descent control switch*
15. Automatic brake hold switch
16. Parking brake switch
17. Shift lever
 - P position switch
18. Push-button power switch
19. Power back door switch*
20. Instrument brightness control

- *: where fitted
 - **:
- The Drive Mode Selector illustrated is for the 4WD model. On the 2WD model, the shape and location differ.

INSTRUMENT PANEL

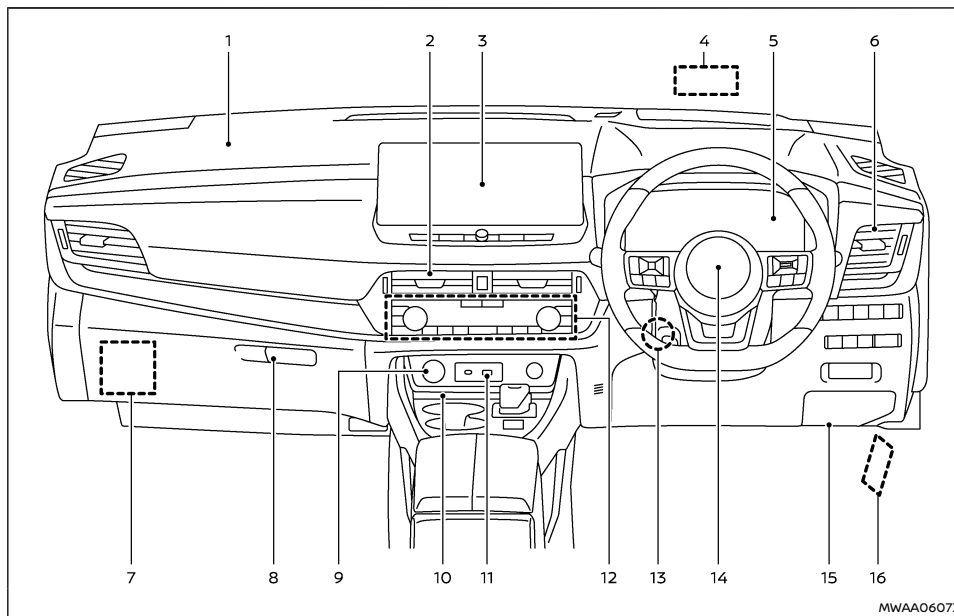
LEFT-HAND DRIVE (LHD) MODEL



- | | |
|---|--|
| <ol style="list-style-type: none"> 1. Side vent 2. Meters and gauges/Clock 3. Head Up Display (HUD)* 4. Centre vent | <ol style="list-style-type: none"> 5. Audio system or navigation system* <ul style="list-style-type: none"> – Rear view monitor* – Intelligent Around View Monitor* – Bluetooth® Hands-Free Phone System – Clock |
|---|--|

6. Front passenger supplemental air bag
 7. Bonnet release handle
 8. Fuse box cover
 9. USB port for TSR map update*
 10. Tilt and telescopic steering lock lever
 11. Driver supplemental front-impact air bag
 12. Heater and air conditioner control
 - Defogger switch
 - Heated seat switches*
 - Heated steering wheel switch*
 - Heated windscreen*
 13. USB (Universal Serial Bus) connection port(s)
 14. Wireless charger*
 15. Power outlet
 16. Glove box
- *: where fitted

RIGHT-HAND DRIVE (RHD) MODEL



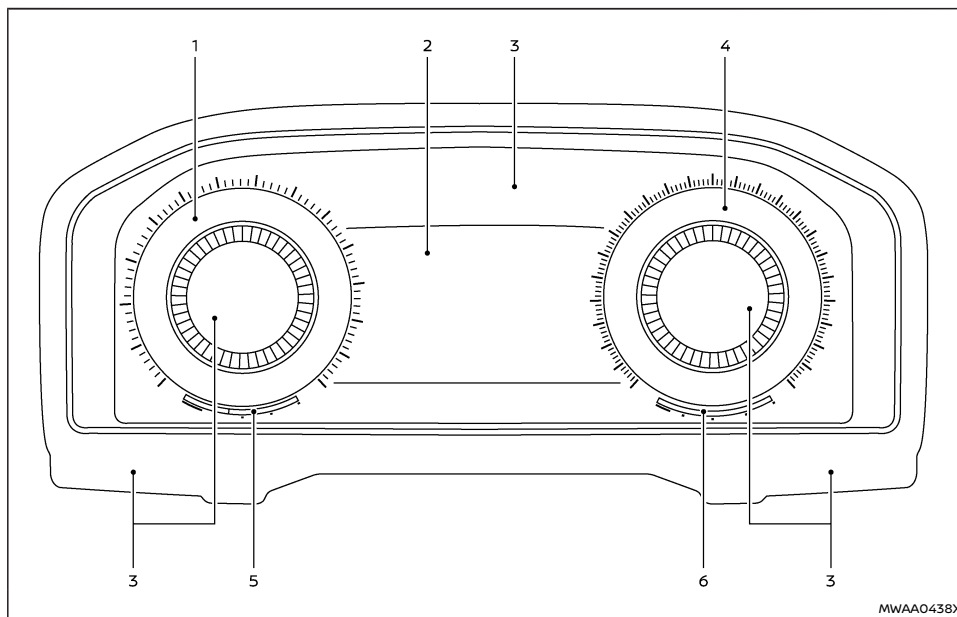
MWA0607X

- | | |
|---|----------------------------|
| 1. Front passenger supplemental air bag | — Clock |
| 2. Centre vent | 4. Head Up Display (HUD)* |
| 3. Audio system or navigation system* | 5. Meters and gauges/Clock |
| — Rear view monitor* | 6. Side vent |
| — Intelligent Around View Monitor* | |
| — Bluetooth® Hands-Free Phone System | |

- | |
|---|
| 7. Fuse box cover |
| 8. Glove box |
| 9. Power outlet |
| 10. Wireless charger* |
| 11. USB (Universal Serial Bus) connection port(s) |
| 12. Heater and air conditioner control |
| — Defogger switch |
| — Heated seat switches* |
| — Heated steering wheel switch* |
| — Heated windscreen* |
| 13. Tilt and telescopic steering lock lever |
| 14. Driver supplemental front-impact air bag |
| 15. USB port for TSR map update* |
| 16. Bonnet release handle |
| *: where fitted |

METERS AND GAUGES

MODELS WITH FULL-SCREEN DISPLAY

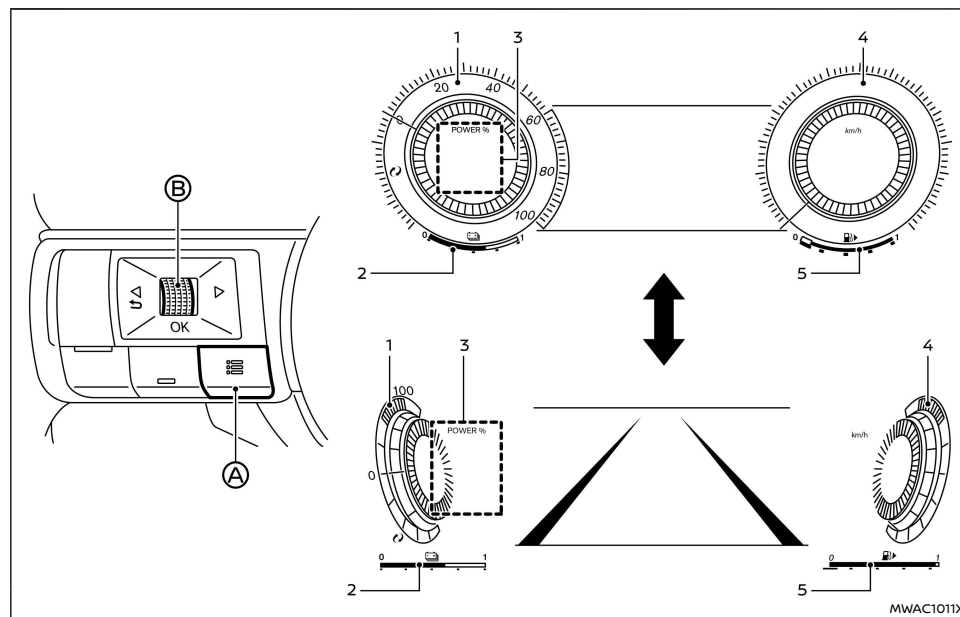


- | | |
|--|--|
| 1. Power meter | 4. Speedometer |
| 2. Vehicle information display
— Odometer | 5. Li-ion battery available charge gauge |
| 3. Warning and indicator lights | 6. Fuel gauge |

CAUTION

- For cleaning, use a soft cloth, dampened with water. Never use a rough cloth, alcohol, benzene, thinner or any kind of solvent or paper towel with a chemical cleaning agent. They will scratch or cause discoloration to the lens.
- Do not spray any liquid such as water on the meter lens. Spraying liquid may cause the system to malfunction.

Changing the meter screen view (models with full-screen display)



1. Power meter
2. Li-ion battery available charge gauge
3. Personal Display
4. Speedometer
5. Fuel gauge

For models with full-screen display, the meter

screen view can be changed to expand the vehicle information display area.

To change the meter screen view:

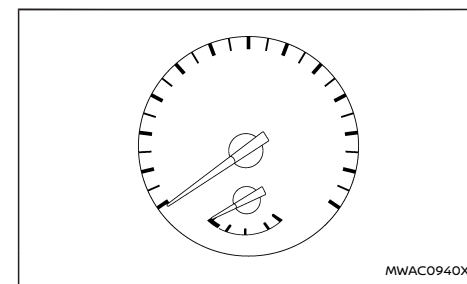
1. Push the shortcut menu button (A) on the left side of the steering wheel.

[Shortcut Menu] appears on the vehicle information display area.

2. Select [Change Display View] by rotating the scroll dial (B) and push it to change the view.

SPEEDOMETER AND ODOMETER

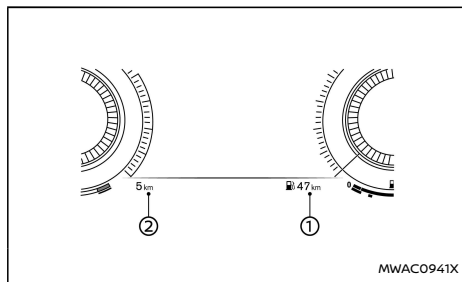
Speedometer



Example

The speedometer indicates vehicle speed (km/h or MPH (where fitted)).

Distance to empty (dte)/Odometer



Example

Distance to empty (dte):

The distance to empty (dte) ① provides an estimation of the distance that can be driven before refuelling. The dte is constantly being calculated, based on the amount of fuel in the fuel tank and the actual fuel consumption.

The display is updated every 30 seconds.

The dte mode includes a low range warning feature. If the fuel level is low, the warning is displayed on the screen.

When the fuel level drops even lower, the dte display will change to "0".

- If the amount of fuel added is small, the display just before the power switch is placed in the OFF position may continue to be displayed.
- When driving uphill or rounding curves, the fuel in the tank shifts, which may momentarily change the display.

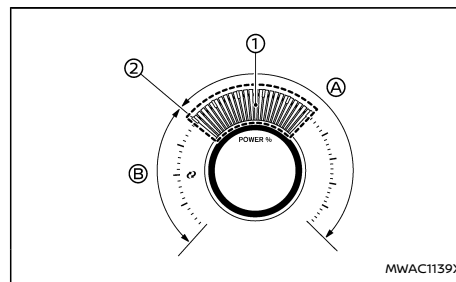
Odometer:

The odometer ② is displayed in the vehicle information display to display the total distance the vehicle has been driven.

POWER METER

The power meter shows the power level of the electric motor for driving when the accelerator pedal is depressed, as well as the level of power regeneration provided to the Lithium ion (Li-ion) battery by the regenerative brake.

Full-screen model



The power meter displays actual power consumption by the electric motor for driving (A) and the regenerative brake power provided to the Li-ion battery (B). The white illuminated part ① in the display moves right or left depending on demand.

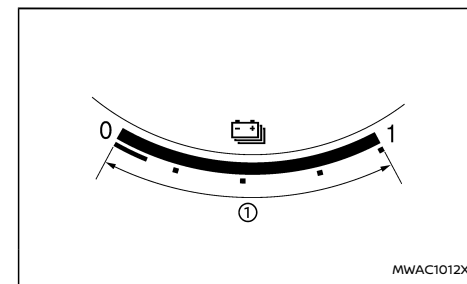
The power meter is in a neutral state ②.

The white illuminated part moves to the right

when power is provided to the electric motor for driving (Li-ion battery discharges).

The white illuminated part moves to the left when power is generated and provided to the Li-ion battery by the regenerative brake system (Li-ion battery charging).

LI-ION BATTERY AVAILABLE CHARGE GAUGE



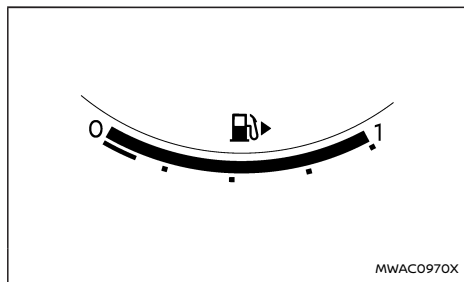
Full-screen model

- ① The gauge indicates the approximate remaining Li-ion battery charge available to drive the vehicle.

NOTE:

Li-ion battery temperature affects the amount of remaining Li-ion battery charge.


FUEL GAUGE




Full-screen model

The fuel gauge indicates the approximate fuel level in the tank when the power switch is in the ON position.

The gauge may move slightly during braking, turning, accelerating, or going up and down hills due to movement of fuel in the tank.

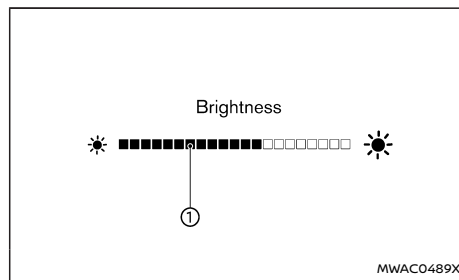
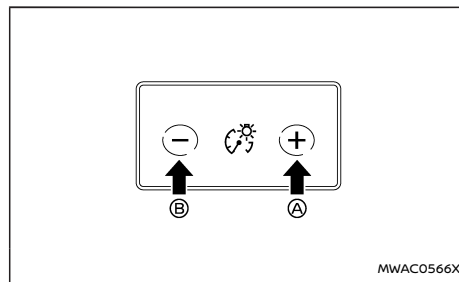
The low fuel warning  appears on the vehicle information display when the fuel level in the tank is getting low. Refuel as soon as it is convenient, preferably before the gauge reads 0 (empty).

The arrow, , indicates the fuel-filler lid is located on the right side of the vehicle.

CAUTION


Refuel before the gauge reads the empty (0) position.



INSTRUMENT BRIGHTNESS CONTROL



The instrument brightness control switch can be operated when the power switch is in the ON position. When the switch is operated, the vehicle information display switches to the brightness adjustment mode.

Push the + side of the switch  to brighten the

instrument panel lights. The bar  moves to the right side.

Push the - side of the switch  to dim the lights. The bar  moves to the left side.

The vehicle information display returns to the normal display when the instrument brightness control switch is not operated for more than 5 seconds.

SHIFT POSITION INDICATOR

The shift position indicator indicates the shift position when the power switch is in the ON or READY to drive position. (See "Electric shift control system" (P.240).)

CAUTION

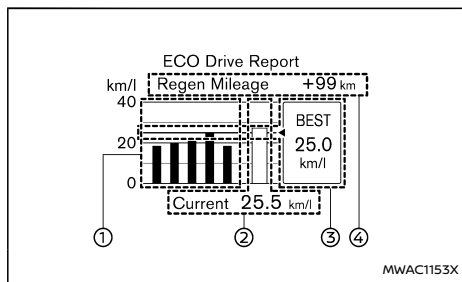
Do not hold the shift lever in any position other than the centre position. Continued driving with the shift lever out of position could lead to damage to the vehicle. Additionally, if the shift lever is placed out of position, the position indicator blinks.

e-Pedal INDICATOR

The e-Pedal indicator in the vehicle information display shows the status of the e-Pedal Step system. When the e-Pedal Step system is turned on, the indicator change to blue and displays [e-Pedal]. When the e-Pedal Step system is turned off, the indicator changes to grey and displays [e-Pedal OFF].

For additional information, see "e-Pedal Step" (P.9).

ECO DRIVE REPORT



Example

When the power switch is placed in the ON or OFF position, the ECO Drive Report is displayed.

- ① Previous 5 times (History)
- ② Current fuel economy
- ③ Best fuel economy
- ④ Regenerated energy (mileage)




































The result of ECO evaluation is displayed when the vehicle is driven for about 10 minutes or more.

- ① Previous 5 times (History)
The average fuel economy for the previous 5 times will be displayed.
- ② Current fuel economy
The most recent average fuel economy will be displayed.
- ③ Best fuel economy
The best fuel economy of the past history will be displayed.

- ④ Regenerated energy (mileage)
The amount of regenerated energy stored in the Lithium ion (Li-ion) battery in one trip will be displayed in terms of distance.

When the [ECO Advice Adjust Tyre Pressures] message appears in the ECO Drive Report, the display can be switched to the Tyre Pressures display by pushing the scroll dial on the steering wheel to show an additional message.

WARNING LIGHTS, INDICATOR LIGHTS AND AUDIBLE REMINDERS

	12-volt battery charge warning light		Low tyre pressure warning light		Hill start assist system indicator light
	Anti-lock Braking System (ABS) warning light		Master warning light		Intelligent Driver Alertness indicator light*
	Approaching Vehicle Sound for Pedestrians (VSP) warning light		Rear Automatic Braking (RAB) system OFF warning light*		Low beam indicator light*
	Brake system warning light (yellow)		Seat belt warning light and chime		Malfunction Indicator Light (MIL)
	Brake warning light (red)		Supplemental Restraint System (SRS) air bag warning light		Power limitation indicator light
	Electronic parking brake warning light		Adaptive LED headlight indicator light*		READY to drive indicator light
	Electric power steering warning light		Automatic brake hold indicator light (white)		Rear fog light indicator light
	Electric shift control system warning light		Automatic brake hold indicator light (green)		Slip indicator light
	Engine oil pressure warning light		Front fog light indicator light*		Small light indicator light
	e-POWER system warning light		High beam assist indicator light*		Turn signal/hazard indicator lights
	Hands OFF warning light*		High beam indicator light		Electronic Stability Programme (ESP) off indicator light
	Intelligent Emergency Braking system OFF warning light*		Hill descent control system on indicator light*		

*: where fitted

CHECKING LIGHTS

With all doors closed, apply the parking brake, fasten the seat belts and place the power switch in the ON position without starting the e-POWER system. The following lights (where fitted) will come on:



The following lights (where fitted) come on briefly and then go off:



If any light does not come on or operates in a way other than described, it may indicate a burned-out bulb and/or a system malfunction. Have the system checked, and if necessary repaired, by a NISSAN dealer or qualified workshop promptly.

WARNING LIGHTS



12-volt battery charge warning light

When the power switch is in the ON position, the 12-volt battery charge warning light illuminates and then turns off.

If the 12-volt battery charge warning light illuminates while the e-POWER system is running, or while driving, it may indicate the charging system is not functioning properly and may need servicing.

CAUTION

The charging system may not be functioning properly if the 12-volt battery charge warning light illuminates while the e-POWER system is running. The e-POWER system will stop operating when the 12-volt battery becomes discharged. Immediately stop the vehicle in a safe place and contact a NISSAN dealer or qualified workshop.



Anti-lock Braking System (ABS) warning light

When the power switch is in the ON position, the Anti-lock Braking System (ABS) warning light illuminates and then turns off. This indicates the ABS is operational.

If the ABS warning light illuminates while the e-POWER system is running, or while driving, it may indicate the ABS is not functioning properly. Have the system checked by a NISSAN dealer or qualified workshop promptly.

If an ABS malfunction occurs, the anti-lock function is turned off. The brake system then operates normally, but without anti-lock assistance. (See "Brake system" (P.369).)



Approaching Vehicle Sound for Pedestrians (VSP) warning light

The Approaching Vehicle Sound for Pedestrians (VSP) warning light illuminates when a malfunction occurs in the VSP system.

Have the VSP system checked by a NISSAN dealer or qualified workshop.

See "Approaching Vehicle Sound for Pedestrians (VSP) system" (P.12).



Brake system warning light (yellow)

The brake system warning light functions for the cooperative regenerative brake, the electronically driven intelligent brake and the electronic parking brake systems. When the power switch is placed in the ON position or in the READY to drive position, the light remains illuminated for about a few seconds. If the light illuminates at any other time, it may indicate that the cooperative regenerative brake, the electronically driven intelligent brake and/or the electronic parking brake systems are not functioning properly. Have the system checked by a NISSAN dealer or qualified workshop. If the brake warning light (red) also illuminates, stop the vehicle immediately and contact a NISSAN dealer or qualified workshop. For additional information, see "Brakes" (P.433).



WARNING

- **Depressing the brake pedal when the power switch position is not in the ON or READY to drive position and/or low brake fluid level may increase the stopping distance and braking will require greater pedal effort as well as pedal travel.**
- **If the brake fluid level is below the minimum or MIN mark on the brake fluid reservoir, do not drive until the brake**

system has been checked at a NISSAN dealer or qualified workshop.

- **The cooperative regenerative brake system may not be working properly if the brake system warning light illuminates when the READY to drive indicator light is ON. If you judge it to be safe, drive carefully to the nearest service station for repairs. Otherwise, have your vehicle towed because driving could be dangerous.**

Brake warning light (red)

When the power switch is placed in the ON position or in the READY to drive position, the brake warning light remains illuminated for about a few seconds. If the brake warning light illuminates at any other time, it may indicate that the hydraulic brake system is not functioning properly. If the brake warning light illuminates, stop the vehicle immediately and contact a NISSAN dealer or qualified workshop.

A buzzer sounds if a malfunction occurs in the brake system power supply.

Low brake fluid warning light:

When the power switch is placed in the ON or READY to drive position, the brake warning light illuminates, and then turns off. If the light illuminates while the power switch is in the READY to drive position with the parking brake not applied, stop the vehicle and perform the following:

1. Check the brake fluid level. If brake fluid is necessary, add fluid and have the system

checked. It is recommended you have this service performed by a NISSAN dealer or qualified workshop. (See "Brake fluid" (P.434).)

2. If the brake fluid level is correct, have the warning system checked. It is recommended you have this service performed by a NISSAN dealer or qualified workshop.

Anti-lock Braking System (ABS) warning indicator:

When the parking brake is released and the brake fluid level is sufficient, if both the brake warning light and the Anti-lock Braking System (ABS) warning light illuminate, it may indicate the ABS is not functioning properly. Have the brake system checked, and if necessary repaired. It is recommended you visit a NISSAN dealer or qualified workshop for this service. (See "Anti-lock Braking System (ABS) warning light" (P.84).)

WARNING

- **Your brake system may not be working properly if the warning light is on. Driving could be dangerous. If you judge it to be safe, drive carefully to the nearest service station for repairs. Otherwise, have your vehicle towed because driving it could be dangerous.**
- **Pressing the brake pedal with the power switch position is other than ON or READY to drive position and/or low brake fluid level may increase your stopping distance and braking will require greater pedal effort as well as pedal travel.**
- **If the brake fluid level is below the mini-**


mum or MIN mark on the brake fluid reservoir, do not drive until the brake system has been checked. It is recommended you visit a NISSAN dealer or qualified workshop for this service.

Electronic parking brake warning light

The electronic parking brake warning light indicates that the electronic parking brake system is operating.

When the power switch is placed in the ON position, the electronic parking brake warning light illuminates. When the e-POWER system is started and the parking brake is released, the warning light turns off.

If the parking brake is not released, the electronic parking brake warning light remains on. Be sure that the electronic parking brake warning light has turned off before driving. (See "Parking brake" (P.189).)

If the electronic parking brake warning light illuminates or flashes while the electronic parking brake system warning light  illuminates, it may indicate that the electronic parking brake system is not functioning properly. Have the electronic parking brake system checked, and if necessary repaired, by a NISSAN dealer or qualified workshop promptly.

Electric power steering warning light

When the power switch is in the ON position, the electric power steering warning light illuminates. After starting the e-POWER system, the electric power steering warning light turns off. This indicates the electric power steering is operational.

If the electric power steering warning light illuminates while the e-POWER system is running, it may indicate the electric power steering is not functioning properly and may need servicing. Have the electric power steering checked by a NISSAN dealer or qualified workshop.

When the electric power steering warning light illuminates, the power assist to the steering will be limited or cease operation, which may cause the steering wheel operation to become heavy. Even if this occurs, the performance of the manual steering is ensured. Grip the steering wheel securely and operate it with greater force than usual.

(See "Electric power steering" (P.369).)

Electric shift control system warning light

When the power switch is in the ON position, the electric shift control system warning light illuminates, and then turns off. This indicates the electric shift control system is operational.

The electric shift control system warning light illuminates when a malfunction occurs in the electric shift control system. Have the system checked by a NISSAN dealer or qualified workshop as soon as possible. When any warning message is

displayed on the vehicle information display, follow the warning message displayed.

Engine oil pressure warning light

When the power switch is in the ON position, the engine oil pressure warning light illuminates. After starting the e-POWER system, the engine oil pressure warning light turns off. This indicates that the oil pressure sensors in the engine are operational.

If the engine oil pressure warning light illuminates or blinks while the engine is running, it may indicate that the engine oil pressure is low.

Stop the vehicle safely as soon as possible. Stop the e-POWER system immediately and call a NISSAN dealer or qualified workshop.

CAUTION

- **Running the engine with the engine oil pressure warning light illuminated could cause serious damage to the engine.**
- **The engine oil pressure warning light is not designed to indicate a low oil level. The oil level should be checked using the dipstick. (See "Engine oil" (P.430).)**

e-POWER system warning light

When the power switch is in the ON position, the e-POWER system warning light illuminates and then turns off.

If the e-POWER system warning light illuminates

while driving, it may indicate that there is a malfunction in the e-POWER system.

Stop the vehicle in a safe place immediately and contact a NISSAN dealer or qualified workshop.

Hands OFF warning light (where fitted)

When the Steering Assist is activated, it monitors the driver's steering wheel operation.

If the steering wheel is not operated or the driver takes his/her hands off the steering wheel for a period of time, the warning light illuminates. If the driver does not operate the steering wheel after the warning light has been illuminated, an audible alert sounds and the warning flashes in the vehicle information display, followed by a quick brake application to request the driver to take control of the vehicle again. If the driver remains unresponsive, the vehicle will automatically turn on the hazard lights and slow to a complete stop. (See "Steering Assist" (P.331).)

Intelligent Emergency Braking system OFF warning light (where fitted)

This light comes on when the power switch is placed in the ON position. It turns off after the e-POWER system is started.

This light illuminates when the Intelligent Emergency Braking with Pedestrian Detection system is set to OFF on the vehicle information display.

If the light illuminates or flashes when the Intelligent Emergency Braking with Pedestrian Detection system is ON, it may indicate that the system

is unavailable. See “Intelligent Emergency Braking with Pedestrian Detection system” (P.338) or “Intelligent Forward Collision Warning (where fitted)” (P.348).



Low tyre pressure warning light

Your vehicle is equipped with a Tyre Pressure Monitoring System (TPMS) that monitors the tyre pressure of all tyres.

The low tyre pressure warning light warns of low tyre pressure or indicates that the TPMS is not functioning properly.

After the power switch is placed in the ON position, this light illuminates for about 1 second and turns off.

Low tyre pressure warning:

If the vehicle is being driven with low tyre pressure, the warning light will illuminate. The [Low Tyre Pressure] warning also appears in the vehicle information display.

When the low tyre pressure warning light illuminates, you should stop and adjust the tyre pressure to the recommended COLD tyre pressure shown on the tyre placard. The low tyre pressure warning light may not automatically turn off when the tyre pressure is adjusted. After the tyre is inflated to the recommended pressure, reset the tyre pressures registered in your vehicle and then drive the vehicle at speeds above 25 km/h (16 MPH). These operations are required to activate the TPMS and turn off the low tyre pressure warning light. Use a tyre pressure gauge to check the tyre pressure.

The [Low Tyre Pressure] warning is active as long as the low tyre pressure warning light remains illuminated.

TPMS resetting must be also performed after a tyre or a wheel is replaced, or the tyres are rotated.

Depending on a change in the outside temperature, the low tyre pressure warning light may illuminate even if the tyre pressure has been adjusted properly. Adjust the tyre pressure to the recommended COLD tyre pressure again when the tyres are cold, and reset the TPMS.

If the low tyre pressure warning light still continues to illuminate after the resetting operation, it may indicate that the TPMS is not functioning properly. Have the system checked by a NISSAN dealer or qualified workshop.

For additional information, see “Vehicle information display” (P.92), “Tyre Pressure Monitoring System (TPMS)” (P.231) and “Tyre Pressure Monitoring System (TPMS)” (P.403).

TPMS malfunction:

If the TPMS is not functioning properly, the low tyre pressure warning light will flash for approximately 1 minute when the power switch is placed in the ON position. The light will remain on after the 1 minute. Have the system checked by a NISSAN dealer or qualified workshop. The [Low Tyre Pressure] warning does not appear if the low tyre pressure warning light illuminates to indicate a TPMS malfunction.

For additional information, see “Tyre Pressure Monitoring System (TPMS)” (P.231).

WARNING

- If the light does not illuminate with the power switch placed in the ON position, have the vehicle checked by a NISSAN dealer or qualified workshop as soon as possible.
- If the light illuminates while driving, avoid sudden steering manoeuvres or abrupt braking, reduce vehicle speed, pull off the road to a safe location and stop the vehicle as soon as possible. Driving with under-inflated tyres may permanently damage the tyres and increase the likelihood of tyre failure. Serious vehicle damage could occur and may lead to an accident and could result in serious personal injury. Check the tyre pressure for all four tyres. Adjust the tyre pressure to the recommended COLD tyre pressure shown on the tyre placard to turn the low tyre pressure warning light OFF. If the light still illuminates while driving after adjusting the tyre pressure, a tyre may be flat or the TPMS may be malfunctioning. If you have a flat tyre, repair it with an emergency tyre puncture repair kit as soon as possible. If no tyre is flat and all tyres are properly inflated, have the vehicle checked by a NISSAN dealer or qualified workshop.
- After adjusting the tyre pressure, be sure to reset the TPMS. Otherwise, the TPMS will not warn of low tyre pressure.
- Replacing tyres with those not originally

specified by NISSAN could affect the proper operation of the TPMS.

CAUTION

- **The TPMS is not a substitute for the regular tyre pressure check. Be sure to check the tyre pressure regularly.**
- **If the vehicle is being driven at speeds of less than 25 km/h (16 MPH), the TPMS may not operate correctly.**
- **Be sure to install the specified size of tyres to the four wheels correctly.**



Master warning light

When the power switch is in the ON position, the master warning light illuminates if a warning message appears in the vehicle information display.

See "Vehicle information display" (P.92).



Rear Automatic Braking (RAB) system OFF warning light (where fitted)

This light comes on when the power switch is placed in the ON position. It turns off after the e-POWER system is started.

This light illuminates when the RAB system is turned off in the vehicle information display with the shift position in R (Reverse).

If the light illuminates or flashes when the RAB system is on, it may indicate that the system is

unavailable. For additional information, see "Rear Automatic Braking (RAB) (where fitted)" (P.358).



Seat belt warning light and chime

The seat belt warning light and chime remind you to fasten the seat belts.

The light illuminates whenever the power switch is placed in the ON position, and will remain illuminated until the seat belts are fastened.

The seat belt warning light for the front passenger will illuminate if the seat belt is not fastened when the front passenger's seat is occupied.

When the vehicle speed exceeds 15 km/h (approximately 10 MPH), the light will continue to blink and the chime will sound for a certain period of time unless the driver's seat belt is securely fastened.

When the vehicle speed exceeds 15 km/h (approximately 10 MPH), if the front passenger's seat or rear seat is occupied, the light will continue to blink and the chime will sound for a certain period of time unless the front passenger's seat belt or rear seat belt is securely fastened.

(See "Seat belts" (P.38).)



Supplemental Restraint System (SRS) air bag warning light

When the power switch is in the ON position, the Supplemental Restraint System (SRS) air bag warning light illuminates for about 7 seconds and then turns off. This indicates the SRS air bag system is operational.

If any of the following conditions occur, the SRS air bag system and pre-tensioner seat belt need servicing. Have the system checked, and if necessary repaired, by a NISSAN dealer or qualified workshop promptly.

- The SRS air bag warning light remains illuminated after about 7 seconds.
- The SRS air bag warning light does not illuminate at all.

Unless checked and repaired, the SRS air bag system and/or pre-tensioner seat belt may not function properly. (See "Supplemental Restraint System (SRS)" (P.57).)

INDICATOR LIGHTS



Adaptive LED headlight indicator light (where fitted)

The adaptive LED headlight indicator light illuminates when the adaptive LED headlight system is turned on and it is operational. (See "Adaptive LED headlight (where fitted)" (P.123).)



Automatic brake hold indicator light (white)

Automatic brake hold indicator light (white) illuminates when Automatic brake hold system is on standby. (See "Automatic brake hold" (P.191).)




Automatic brake hold indicator light (green)

Automatic brake hold indicator light (green) illuminates when Automatic brake hold system is operating. (See "Automatic brake hold" (P.191).)

 Front fog light indicator light (where fitted)


The front fog light indicator light illuminates when the front fog lights are on. (See "Fog light switch" (P.128).)

 High beam assist indicator light (where fitted)

The high beam assist indicator light illuminates when the high beam assist system is turned on and it is operational. (See "High beam assist (where fitted)" (P.121).)

 High beam indicator light

The high beam indicator light illuminates when the headlight high beam is on. The indicator turns off when the low beam is selected. (See "Headlight and turn signal switch" (P.120).)

 Hill descent control system on indicator light (where fitted)

When the power switch is placed in the ON position the hill descent control system on indicator light illuminates briefly and then turns off. This indicates that the hill descent control system is operational.


The light illuminates when the hill descent control system is activated.

If the hill descent control switch is on and the indicator light blinks, the system is not engaged.

If the indicator light does not illuminate or blink

when the hill descent control switch is on, the system may not be functioning properly. Have the system checked by a NISSAN dealer or qualified workshop.

For additional information, see "Hill descent control system (where fitted)" (P.375).

 Hill start assist system indicator light

When the power switch is in the ON position, the hill start assist system indicator light illuminates and then turns off.

This light illuminates when the hill start assist system is operating.

See "Hill Start Assist system" (P.375).

 Intelligent Driver Alertness indicator light (where fitted)

When the power switch is in the ON position, the Intelligent Driver Alertness indicator light illuminates. After starting the e-POWER system, the Intelligent Driver Alert indicator light turns off. This indicates that the Intelligent Driver Alertness system is operational.

The Intelligent Driver Alertness indicator light will illuminate white when the system is operating. If the light illuminates yellow while the e-POWER system is running, it may indicate that the Intelligent Driver Alertness system is not functioning properly. Have the system checked by a NISSAN dealer or qualified workshop.

(See "Intelligent Driver Alertness (where fitted)" (P.355).)

 Low beam indicator light (where fitted)

The low beam indicator light illuminates when the headlight low beam is on. The indicator turns off when the high beam is selected. (See "Headlight and turn signal switch" (P.120).)

 Malfunction Indicator Light (MIL)

CAUTION

- **Continuing vehicle operation without proper servicing of the emission control system could lead to poor driveability, reduced fuel economy, and damage to the emission control system, which may affect the vehicle's warranty coverage.**
- **Incorrect setting of the emission control system may lead to non-compliance of local and national emission laws and regulations.**

When the power switch is in the ON position, the Malfunction Indicator Light (MIL) illuminates. After starting the e-POWER system, the MIL turns off. This indicates that the emission control system is operational.

When the power switch is in the ON position, sometimes the MIL may illuminate for 20 seconds and then blink for 10 seconds, without the engine running. This is due to a function of checking the emission control system, and it is not a malfunction. After a few normal drives, this function will not occur and the MIL stays illuminated with the power switch in the ON position.

If the MIL illuminates or blinks when the READY to drive indicator light illuminates, it may indicate a potential emission control system malfunction. In this case, the emission control system may not function properly and may need servicing. Have the system checked, and if necessary repaired, by a NISSAN dealer or qualified workshop promptly.

Precautions:

To reduce or avoid possible damage to the engine control system when the MIL blinks:

- Avoid driving at speeds above 70 km/h (43 MPH).
- Avoid sudden acceleration or deceleration.
- Avoid going up steep uphill grades.
- Avoid carrying or towing unnecessary loads.



Power limitation indicator light

When the power switch is in the ON position, the power limitation indicator light illuminates and then turns off.

When the power limitation indicator light is illuminated with the power switch in the READY to drive position, the power provided to the electric motor for driving and the power generator is reduced. Therefore, the vehicle is not as responsive when the accelerator pedal is depressed while the power limitation indicator light is illuminated.

When this light illuminates and any message appears on the vehicle information display, follow the instructions.

This light illuminates in the following conditions.

- Li-ion battery charge is extremely low.
- Li-ion battery temperature is extremely low.
- When the temperature of e-POWER system is high (motor, coolant system, Li-ion battery, etc.).
- When the electric power generation output is limited.

Immediately before the Li-ion battery is discharged and when the Low Fuel warning is also displayed in the vehicle information display, refuel as soon as possible.

If this light illuminates because the Li-ion battery is cold due to low outside temperatures, move the vehicle to a warmer location.

If the light illuminates because the Li-ion battery or the e-POWER system temperature is extremely high, stop the vehicle in a safe location and wait until the light turns off.

This light also illuminates in the following condition.

- If the accelerator pedal is depressed when the vehicle is stopped and the shift lever is placed in the N (Neutral) position.

While the accelerator pedal is depressed, the light illuminates and a message appears in the vehicle information display, and chime will sound. When the accelerator pedal is released, the indicator light and the message will turn off and chime will stop.

If the light illuminates in a situation other than those described above, or if it does not turn off, there may be a system malfunction. Contact a NISSAN dealer or qualified workshop.

WARNING

Power limitation mode can result in reduced power and vehicle speed. The reduced speed may be lower than other traffic, which could increase the chance of a collision. Be especially careful when driving. If the vehicle cannot maintain a safe driving speed, pull to the side of the road in a safe area.



READY to drive indicator light

The READY to drive indicator light illuminates when the e-POWER system is powered and the vehicle may be driven.

If the light is blinking, keep pushing the power switch with the brake pedal depressed until the light stops blinking (illuminates).



Rear fog light indicator light

The rear fog light indicator light illuminates when the rear fog light is on. (See "Fog light switch" (P.128).)





Slip indicator light

When the power switch is in the ON position, the slip indicator light illuminates and then turns off.

The light will blink when the Electronic Stability Programme (ESP) system or the traction control system is operating, thus alerting the driver that the vehicle is nearing its traction limits. The road surface may be slippery.

If the light illuminates while the ESP system is on, this light alerts the driver to the fact that the ESP system's fail-safe mode is operating, for example the ESP system may not be functioning properly. Have the system checked, and if necessary repaired, by a NISSAN dealer or qualified workshop promptly. If a malfunction occurs in the system, the ESP system function will be cancelled but the vehicle is still driveable. For additional information, see "Electronic Stability Programme (ESP) system" (P.372) of this manual.

Small light indicator light

This indicator illuminates when the headlight switch is turned to the "AUTO",  or  position and the front clearance lights, rear combination lights, number plate lights or headlights are on. The indicator turns off when these lights are turned off.

Turn signal/hazard indicator lights


The turn signals/hazard indicator lights blink when the turn signal switch lever or hazard indicator flasher switch is ON. (See "Headlight and turn signal switch" (P.120) or "Hazard warning flasher switch" (P.402).)

Electronic Stability Programme (ESP) off indicator light

The light comes on when the ESP is turned OFF. This indicates that the ESP system and traction control system are not operating.

Turn the ESP on using the vehicle information

display, or restart the e-POWER system and the system will operate normally. (See "Electronic Stability Programme (ESP) system" (P.372).)

The light also comes on when placing the power switch in the ON position. The light will turn off after about 2 seconds if the system is operational. If the light stays on or comes on along with the  indicator light while you are driving, have the system checked by a NISSAN dealer or qualified workshop.

WARNING

The ESP should remain on unless freeing a vehicle from mud or snow.



While the ESP system is operating, you might feel a slight vibration or hear the system working when starting the vehicle or accelerating, but this is not a malfunction.

AUDIBLE REMINDERS

Brake pad wear warning

The disc brake pads have audible wear warnings. When a brake pad requires replacement, it will make a high pitched scraping sound when the vehicle is in motion. This scraping sound will first occur only when the brake pedal is depressed. After more wear of the brake pad, the sound will always be heard even if the brake pedal is not depressed. Have the brakes checked as soon as possible if the warning sound is heard.

Light reminder chime

The light reminder chime will sound when the headlight switch is placed in the  or  position after the e-POWER system was turned off, and the driver's door is opened with the light is on.

Turn the headlight switch to the "AUTO" position when you leave the vehicle.

Door lock warning chime

When the chime sounds, be sure to check both the vehicle and the Intelligent Key. See "Troubleshoot- ing guide" (P.166).

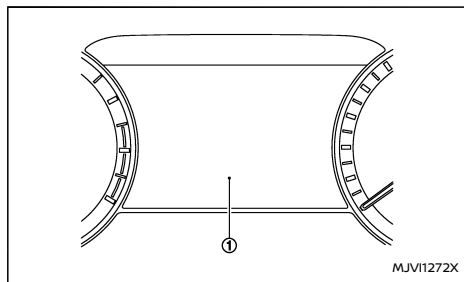
Driving Aid chimes (where fitted)

An audible alert/chime may be heard if any of the following systems (where fitted) are active:

- Emergency Lane Assist (ELA)
- Blind Spot Warning (BSW)
- Intelligent Blind Spot Intervention
- Rear Cross Traffic Alert (RCTA)
- Intelligent Cruise Control (ICC)
- ProPILOT Assist
- Intelligent Emergency Braking with Pedestrian Detection
- Intelligent Forward Collision Warning
- Intelligent Driver Alertness
- Rear Automatic Braking (RAB)
- Parking sensor (sonar) system

For additional information, refer to the "5. Starting and driving" section of this manual.

VEHICLE INFORMATION DISPLAY



Example

The vehicle information display ① is located as shown above, and it displays the warnings and information. The following items are also displayed if the vehicle is equipped with them:

- Vehicle settings
- Trip computer information
- Driver Assistance
- Cruise control system information
- ProPILOT Assist
- Intelligent Key operation information
- Audio information
- Navigation - turn by turn
- Indicators and warnings
- Tyre pressure information
- Other information

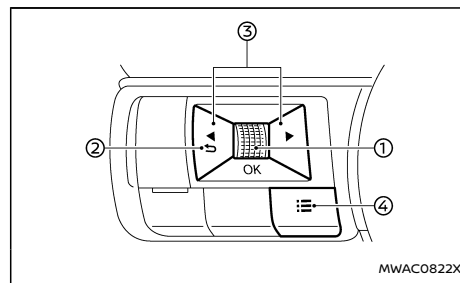
Please note that the wording displayed in the vehicle information display in this manual is written in UK English. There are some differences in the information for the UK and U.S. English versions of the system.



For language setting, see "Unit/Language" (P.100).

CHANGING THE METER SCREEN VIEW (models with full-screen display)





For the model with full-screen display, the meter screen view can be changed to expand the vehicle information display area. See "Changing the meter screen view (models with full-screen display)" (P.79) for how to change the view.

HOW TO USE THE VEHICLE INFORMATION DISPLAY




The vehicle information display can be changed using the scroll dial ①,  ②, and  ③ located on the steering wheel.

- ① Scroll dial - navigate through the items and change or select an item in vehicle information display
this scroll dial allows up/down navigation and push to select

- ②  - go back to the previous menu
- ③   - change from one display screen to the next (i.e. trip, Fuel economy)
- ④  - display the [Shortcut Menu] screen

SHORTCUT MENU

When the  button ④ is pushed, the [Shortcut Menu] screen appears on the vehicle information display. Select the menu by rotating the scroll dial ① and push it.

The following menus are available:

- [Driver Assist Custom] (where fitted)
Allows user to enable or disable the system settings in the [Custom Mode Setup] menu.
- [Change Display View] (where fitted)
Allows user to change the meter screen view. (See "Changing the meter screen view (models with full-screen display)" (P.79).)
- [Audio Source] (where fitted)
Allows user to select the available audio source. (See the separate NissanConnect Owner's Manual for the audio system.)
- [Custom Mode Setup] (where fitted)
Allows user to set up preferred driver assist modes.
- [Personal Display]
Allows user to change the [Personal Display] settings. (See "Personal Display" (P.95).)

STARTUP DISPLAY

When the power switch is placed in the ON position, the vehicle information display may display the following screens if the vehicle is equipped with them:

- [Home]
- [Blank]
- [Speed]
- [Drive Computer]
- [Fuel Economy History]
- [ECO Pedal Guide]
- [Tyre Pressures]
- [Energy Flow]
- [Navigation]
- [Compass]
- [Audio]
- [Driving Aids]
- [Intelligent Cruise Control] (ICC)
- [ProPILOT Assist]
- [Traffic Sign]
- [Warnings]
- [Settings]

Warnings will only appear if there are any present. For more information on warnings and indicators, see "Vehicle information display warnings and indicators" (P.101).

To control what items appear in the vehicle information display, see "Settings" (P.93).

SETTINGS

The setting mode allows user to change the information displayed in the vehicle information display and some settings:

- [ESP Setting]
- [Driver Assistance]
- [Personal Display] (where fitted)
- [Head-Up Display] (where fitted)
- [ECO Settings]
- [Tyre Pressures]
- [Clock]
- [Vehicle Settings]
- [Maintenance]
- [Display Settings]
- [Unit/Language]
- [I-Key Link] (where fitted)
- [Factory Reset]

ESP Setting

To change the setting, use the scroll dial ① to select and push it.

- [System]

Allows user to turn the Electronic Stability Programme (ESP) system ON or OFF. By default the ESP system will be turned ON. If the ESP system is turned off, the ESP OFF indicator light will illuminate.

NOTE:

The vehicle should be driven with the ESP system ON for most driving conditions. (See

"Electronic Stability Programme (ESP) system" (P.372.)

Driver Assistance

To change the status, warnings or turn on or off any of the systems/warnings displayed in the [Driver Assistance] menu, use the scroll dial ① to select and change a menu item:

- [Steering Assist] (where fitted)
- [Lane] (where fitted)
- [Blind Spot] (where fitted)
- [Emergency Brake] (where fitted)
- [Traffic Sign Assist] (where fitted)
- [CRUISE Navi Link] (where fitted)
- [Speed Limit Link] (where fitted)
- [Speed Link Offset] (where fitted)
- [Parking Aids]
- [Rear Cross Traffic Alert] (where fitted)
- [Driver Attention Alert] (where fitted)
- [Timer Alert]
- [Low Temp. Alert]
- [Steering Effort]
- [Chassis Control]

[Steering Assist] (where fitted):

Allows user to turn the Steering Assist ON/OFF. (See "ProPILOT Assist (where fitted)" (P.309).)

[Lane] (where fitted):

- [Emergency Lane] (where fitted)
- Allows user to turn the Emergency Lane Assist (ELA) system ON/OFF.

- [Advanced Lane] (where fitted)
Allows user to turn the Advanced Lane function of the ELA system ON/OFF.
- [Lane Sensitivity] (where fitted)
Allows user to select an item from below.
 - [Strong]
 - [Normal]
 - [Mild]
- [Vibration level]
Allows user to select an item from below.
 - [High]
 - [Middle]
 - [Low]

(See “Emergency Lane Assist (ELA) (where fitted)” (P.263).)

[Blind Spot] (where fitted):

- [Warning]
Allows user to turn the Blind Spot Warning (BSW) system ON/OFF.
- [Intervention] (where fitted)
Allows user to turn the Intelligent Blind Spot Intervention system ON/OFF.

(See “Blind Spot Warning (BSW) (where fitted)” (P.270) and “Intelligent Blind Spot Intervention (where fitted)” (P.276).)

[Emergency Brake] (where fitted):

Models without Rear Automatic Braking (RAB) system:

Allows user to turn the Intelligent Emergency Braking with Pedestrian Detection system and

Intelligent Forward Collision Warning system ON/OFF.

Models with Rear Automatic Braking (RAB) system:

- [Front]
Allows user to turn the Intelligent Emergency Braking with Pedestrian Detection system and Intelligent Forward Collision Warning system ON/OFF.
- [Rear]
Allows user to turn the Rear Automatic Braking (RAB) system ON/OFF.

(See “Intelligent Emergency Braking with Pedestrian Detection system” (P.338), “Intelligent Forward Collision Warning (where fitted)” (P.348) and “Rear Automatic Braking (RAB) (where fitted)” (P.358).)

[Traffic Sign Assist] (where fitted):

- [Speed Limit]
Allows user to customise the TSR system
 - [Warning]
 - [Info Only]
 - [OFF]
- [New Limit Alert]
Allows user to turn the notification (chime) ON/OFF.
- [Database Version]
Allows user to confirm the version of the map data.
- [Update by USB]
Allows user to update the map data.

- [1. Verify Vehicle Info]
- [2. Install New Data]

- [License Information]
Allows user to confirm the map license information.
 - [License Expiration]
 - [License State]
- (See “Traffic Sign Recognition (TSR) (where fitted)” (P.257).)

[CRUISE Navi Link] (where fitted):

Allows user to turn the CRUISE Navi Link function ON/OFF.

[Speed Limit Link] (where fitted):

Models without ProPILOT Assist with Navi-link:

Allows user to turn the Speed Limit Link function ON/OFF.

Models with ProPILOT Assist with Navi-link:

Allows user to customise the Speed Limit Link function.

- [OFF]
- [Prompt]
- [Auto]

[Speed Link Offset] (where fitted):

Allows user to set whether the speed limit used by the Speed Limit Link function should be accepted exactly, or with a tolerance of -10 km/h (-5 MPH) to +10 km/h (+5 MPH) adjust.

[Parking Aids]:

To change the status or turn on or off any of the

systems displayed in the [Parking Aids] menu, use the scroll dial ① to select and change a menu item:

- [Moving Object] (where fitted)
Allows user to turn the Moving Object Detection (MOD) ON/OFF.
- [Display]
Allows user to turn the parking sensor (sonar) system display ON/OFF.
- [Front]
Allows user to turn the front sensors ON/OFF.
- [Rear]
Allows user to turn the rear sensors ON/OFF.
- [Distance]
Allows user to select the sensor's detection distance ([Far], [Medium] or [Near]).
- [Volume]
Allows user to select the volume of the tone ([High], [Medium] or [Low]).

(See "Moving Object Detection (MOD) (where fitted)" (P.216) and "Parking sensor (sonar) system" (P.377).)

[Rear Cross Traffic Alert] (where fitted):

Allows user to turn the Rear Cross Traffic Alert (RCTA) system ON/OFF. (See "Rear Cross Traffic Alert (RCTA) (where fitted)" (P.284).)

[Driver Attention Alert] (where fitted):

Allows user to turn the Intelligent Driver Alertness on or off. (See "Intelligent Driver Alertness (where fitted)" (P.355).)

[Timer Alert]:

Allows user to adjust the Timer Alert or reset.

- (Current Time)/(Set Time)
- [Reset]

[Low Temp. Alert]:

Allows user to turn the Low Temperature Alert function ON/OFF.

[Steering Effort]:

Allows user to adjust the power steering to reduce or increase steering effort.

- [Drive Mode]
- [Standard]
- [Sport]

[Chassis Control]:

- [Trace Control]
Allows user to turn the function ON/OFF.
(See "Intelligent Trace Control" (P.374).)

Personal Display

To change the display in the [Personal Display] menu, use the scroll dial ① to select and change a menu item:

- [Blank]
- [Navigation] (where fitted)
- [Time to Destination] (where fitted)
- [Trip]
 - [Since Reset]
 - [Since Start]
 - [Since Refuel]
- [Gear Position]
- [Average Speed]

- [Since Reset]
- [Since Start]
- [Since Refuel]
- [Brake Lamp]

Head-Up Display (where fitted)

To change the status or turn on or off any of the systems displayed in the [Head-Up Display] menu, use the scroll dial ① to select and change a menu item:

- [Brightness]
- [Height]
- [Rotation]
- [Contents Selection]
 - [Navigation] (where fitted)
 - [Driving Aids]
 - [Traffic Sign]
 - [Audio]
 - [Telephone]
- [Reset]
(See "Head Up Display (HUD) (where fitted)" (P.118).)

ECO Settings

This setting allows user to change the ECO mode system settings.

To change the status or turn on or off any of the systems displayed in the [ECO Settings] menu, use the scroll dial ① to select and change a menu item:

- [ECO Drive Mode]
 - [ECO Cruise Control]

- [ECO Climate Control]
- [ECO Info Settings]
 - [ECO Indicator]
 - [ECO Drive Report]
- [View History]

To reset the View History:

 - 1) Select [View History] using the scroll dial ① and push it.
 - 2) Push the scroll dial ①.
 - 3) Select [Yes] by pushing the scroll dial ①.
- [Tyre ECO advice] (where fitted)

Push the scroll dial ① to turn the [Tyre ECO advice] ON/OFF.

Tyre Pressures

The settings in the [Tyre Pressures] menu are all related to the Tyre Pressure Monitoring System (TPMS). (See “Tyre Pressure Monitoring System (TPMS)” (P.231) and “Tyre placard” (P.461).)

- [Target Front]
- [Target Rear]
- [Tyre Pressure Unit]
- [Calibrate]

[Target Front]:

The [Target Front] tyre pressure is the pressure specified for the front tyres on the tyre placard.

Use the scroll dial ① to select and change the value for the “Target Front” tyre pressure.

[Target Rear]:

The [Target Rear] tyre pressure is the pressure specified for the rear tyres on the tyre placard.

Use the scroll dial ① to select and change the value for the [Target Rear] tyre pressure.

[Tyre Pressure Unit]:

The unit for tyre pressure that is shown in the vehicle information display can be changed to:

- [psi]
- [bar]
- [kPa]
- [kgf/cm²]

Use the scroll dial ① to select and change the unit.

If necessary, refer to the following table to convert between units.

kPa	200	210	220	230	240	250	260	270	280	290	300	310	320	330	340
psi	29	30	32	33	35	36	38	39	41	42	44	45	46	48	49
bar	2.0	2.1	2.2	2.3	2.4	2.5	2.6	2.7	2.8	2.9	3.0	3.1	3.2	3.3	3.4
kg/cm ²	2.0	2.1	2.2	2.3	2.4	2.5	2.6	2.7	2.8	2.9	3.0	3.1	3.2	3.3	3.4

MJVI0938X

Calibrate:

The tyre pressure is affected by the temperature of the tyre; the tyre temperature increases when the car is driven. To be able to accurately monitor the tyre air leakage and to prevent false TPMS warnings due to changes in temperature, the TPMS system uses temperature sensors in the tyres to perform temperature compensation calculations.

On rare occasions it may be necessary to recalibrate the TPMS system reference temperature. This operation should only be performed when the actual tyre pressure has been adjusted, while the current ambient temperature is significantly different to the current calibration temperature. (See "Tyre Pressure Monitoring System (TPMS)" (P.231).) Use the scroll dial ① to start or cancel the calibration process. (See "TPMS resetting" (P.232).)

Clock

Allows user to adjust the clock settings and time within the vehicle information display.

- [Display]
- [Clock Mode] (where fitted)
- [Clock Format]
- [Summer Time] (where fitted)
- [Time Zone] (where fitted)
- [Set Clock Manually] (where fitted)

The clock may also be set in the centre display. See the separate NissanConnect Owner's Manual.

Vehicle Settings

The vehicle settings allows user to change settings for the following menus.

- [Power Back Door] (where fitted)
- [Lighting]
- [Turn indicator] (where fitted)
- [Locking]

- [Wipers]
- [Alarm System] (where fitted)
- [Driving Position] (where fitted)
- [Rear Door Alert] (where fitted)
- [Mirror Fold]

The vehicle settings can be changed using the scroll dial ①.

[Power Back Door] (where fitted):

This allows user to turn the power back door ON or OFF.

[Lighting]:

The [Lighting] menu has the following options:

- [Welcome Light]
The welcome lighting can be set to be ON or OFF. Use the scroll dial ① to turn this feature ON or OFF.
- [Auto Room Lamp]
The interior light can be set to be ON or OFF. Use the scroll dial ① to turn this feature ON or OFF.
- [Mood Lighting] (where fitted)
The brightness of the Mood Lighting can be adjusted. Use the scroll dial ① to select the brightness.

[Turn indicator] (where fitted):

The [3 flashes] overtaking feature can be set to be ON or OFF. Use the scroll dial ① to turn this feature ON or OFF.

[Locking]:

The [Locking] menu has the following options:

- [I-Key Door Lock] (where fitted)
When this item is turned on, the lock or capacitive unlock sensors (on the front door handles) and the request switch are activated. Use the scroll dial ① to activate or deactivate this function.
- [Selective Unlock]
When this item is turned on, only the corresponding door is unlocked when using the capacitive unlock sensor on the door handles or the request switch (where fitted). All the doors can be unlocked if the lock sensor is touched within 5 seconds after using the capacitive unlock sensor or the request switch is pushed again within 5 seconds after pushing the request switch. When this item is turned to off, all the doors will be unlocked when using the capacitive unlock sensor or the request switch once. Use the scroll dial ① to activate or deactivate this function.
If the approach unlock function is activated while the selective unlock function is turned on, the selective unlock function is deactivated automatically. If the selective unlock function is activated while the approach unlock function is turned on, the approach unlock function is deactivated automatically.
- [Walk Away Lock]
When this item is turned on, the walk away lock function is activated. Use the scroll dial ① to activate or deactivate this function. (See "Walk away lock function" (P.164).)
- [Approach Unlock] (where fitted)
When this item is turned on, the approach

unlock function is activated. Use the scroll dial ① to activate or deactivate this function. If the approach unlock function is activated while the selective unlock function is turned on, the selective unlock function is deactivated automatically. If the selective unlock function is activated while the approach unlock function is turned on, the approach unlock function is deactivated automatically. (See "Approach unlock function" (P.164).)

[Wipers]:

The [Wipers] menu has the following options:

- [Speed Dependent]
The [Speed Dependent] feature can be activated or deactivated. Use the scroll dial ① to turn this feature ON or OFF.
- [Auto Wipe]
The [Auto Wipe] feature can be activated or deactivated. Use the scroll dial ① to turn this feature ON or OFF.
- [Reverse Link]
The [Reverse Link] wiper feature can be set to be ON or OFF. Use the scroll dial ① to turn this feature ON or OFF.

[Alarm System] (where fitted):

The [Alarm System] menu has the following options:

- [Always ON]
When this item is selected, the ultrasonic sensor and tilt sensor (where fitted) will activate each time the alarm is set.

- [Ask on Exit]
When this item is selected, the alarm system will provide the choice to disable the ultrasonic sensor and tilt sensor (where fitted) after the power switch is placed in the OFF position.
- [Disable Once]
When this item is selected, the ultrasonic sensor and tilt sensor (where fitted) will be disabled until the next time the power switch is placed in the ON position.

[Driving Position] (where fitted):

- [Exit Seat Slide]
Allows user to turn this feature ON or OFF. (See "Memory seat (where fitted)" (P.187).)

[Rear Door Alert] (where fitted):

Allows user to select an item below.

- [Horn & Alert]
- [Alert Only]
- [OFF]

[Mirror Fold]:

Allows user to select an item below.

- [Auto Fold Off]
- [Unfold at Power on]
- [Unfold at Unlock]

Maintenance

The maintenance mode allows user to check the distance to oil change or set alerts for the reminding of maintenance intervals. To change an item:

Select "Maintenance" using the scroll dial ① and push it.

- [Service]
- [Air Filter]
- [Tyre]
- [Other]

[Service]:

The Service (Oil Control System) informs the distance to oil change. Never exceed one year or 15,000 km (9,000 miles) (except for Ukraine) or 10,000 km (6,250 miles) (for Ukraine) between oil change intervals.

Display when power is ON	Display timing	Action Required
Engine Oil Service due in xxx km (miles)	Remaining oil life is less than 1,500 km (940 miles), 1,000 km (625 miles), 500 km (312.5 miles), 400 km (250 miles), 300 km (187.5 miles), 200 km (125 miles), 100 km (62.5 miles).	Plan to have your vehicle serviced.
Engine Oil Service due	Remaining oil life is 0 km (0 miles).	Have your vehicle serviced within two weeks or less than 800 km (500 miles).

The oil change interval cannot be adjusted manually.

The distance to oil change interval is calculated depending on the driving conditions and set automatically by the oil control system. A reminder will be displayed when approaching the end of the service interval.

When the Factory Reset option is selected in the vehicle information display, the oil control system will also be reset to initial value. Please change the engine oil when Factory Reset is selected.

CAUTION

If the oil replacement indicator is displayed, change the engine oil within two weeks or less than 800 km (500 miles).

Operating the vehicle with deteriorated oil can damage the engine.

To reset oil control system:

1. Place the power switch in the ON position.
2. Push the ◀ and ▶ buttons on the steering wheel until [Settings] appears in the vehicle information display. Use the scroll dial ① to select [Maintenance]. Then, push the scroll dial ①.
3. Select the [Service] and push the scroll dial ①.
4. Push the scroll dial ① according to the reset instructions displayed at the bottom of the [Service] maintenance screen.

When the user sets an alert for changing the engine oil in an other menu, reset both [Service] and the menu after changing the engine oil.

[Air Filter]:

This indicator appears when user set distance comes for changing the air filter. You can set or reset the distance for checking or replacing these items. For scheduled maintenance items and intervals, see a separate maintenance booklet.

[Tyre]:

This indicator appears when the user set distance comes for replacing tyres. You can set or reset the distance for replacing tyres.

⚠ WARNING

The tyre replacement indicator is not a substitute for regular tyre checks, including tyre pressure checks. (See "Changing tyres and wheels" (P.449).) Many factors including tyre inflation, alignment, driving habits and road conditions affect tyre wear and when tyres should be replaced. Setting the tyre replacement indicator for a certain driving distance does not mean your tyres will last that long. Use the tyre replacement indicator as a guide only and always perform regular tyre checks. Failure to perform regular tyre checks, including tyre pressure checks could result in tyre failure. Serious vehicle damage could occur and may lead to a collision, which could result in serious personal injury or death.

[Other]:

This indicator appears when the user set distance comes for checking or replacing maintenance items other than the engine oil, air filter and tyres. Other maintenance items can include such a thing

as tyre rotation. You can set or reset the distance for checking or replacing the items.

Display Settings

The display settings allows user to choose from the various meter selections.

The display settings can be changed using the scroll dial ①.

Contents Selection:

Displays available screens that can be shown in the vehicle information display.

Route Guidance (where fitted):

To change the setting, use the scroll dial ① to select and push it.

- [Alert(s)]

The [Alert(s)] allows user to turn the Navigation Settings alerts on or off.

AUTO Cruise Display (where fitted):

The [AUTO Cruise Display] allows user to turn the cruise screen transition on or off.

Welcome Effect:

The [Welcome Effect] displays the available welcome effect setting.

- Animation
- Sound

Operation Guidance:

The [Operation Guidance] displays the available operation guidance settings.

- [Lights]

- [Wiper]
 - [Front]
 - [Rear]
- [High beam assist] (where fitted)
- [Adaptive Headlight] (where fitted)
- [Seat Memory] (where fitted)
- [Speed limiter] (where fitted)
- [Cruise Control] (where fitted)

Unit/Language

The units or language that are shown in the vehicle information display can be changed:

- [Distance/Fuel]
- [Tyre Pressures]
- [Temperature]
- [Language]

Use the scroll dial ① to select and change the units of the vehicle information display.

[Distance/Fuel]:

The unit for the mileage that is shown in the vehicle information display can be changed.

- [miles, MPG] (where fitted)
- [km, l/100km]
- [km, km/l]
- [miles, MPG(UK)] (where fitted)
- [miles, MPG(US)] (where fitted)

Use the scroll dial ① to select and change the unit.

[Tyre Pressures]:

The unit for tyre pressures that is shown in the vehicle information display can be changed to:

- [psi]
 - [bar]
 - [kPa]
 - [kgf/cm²]
- (See "Tyre Pressures" (P.96).)

[Temperature]:

The temperature that is shown in the vehicle information display can be changed from:

- [°C]
- [°F]

Use the scroll dial ① to toggle choices.

[Language]:

The language of the vehicle information display can be changed.

Use the scroll dial ① to select and change the language of the vehicle information display.

I-Key Link (where fitted)

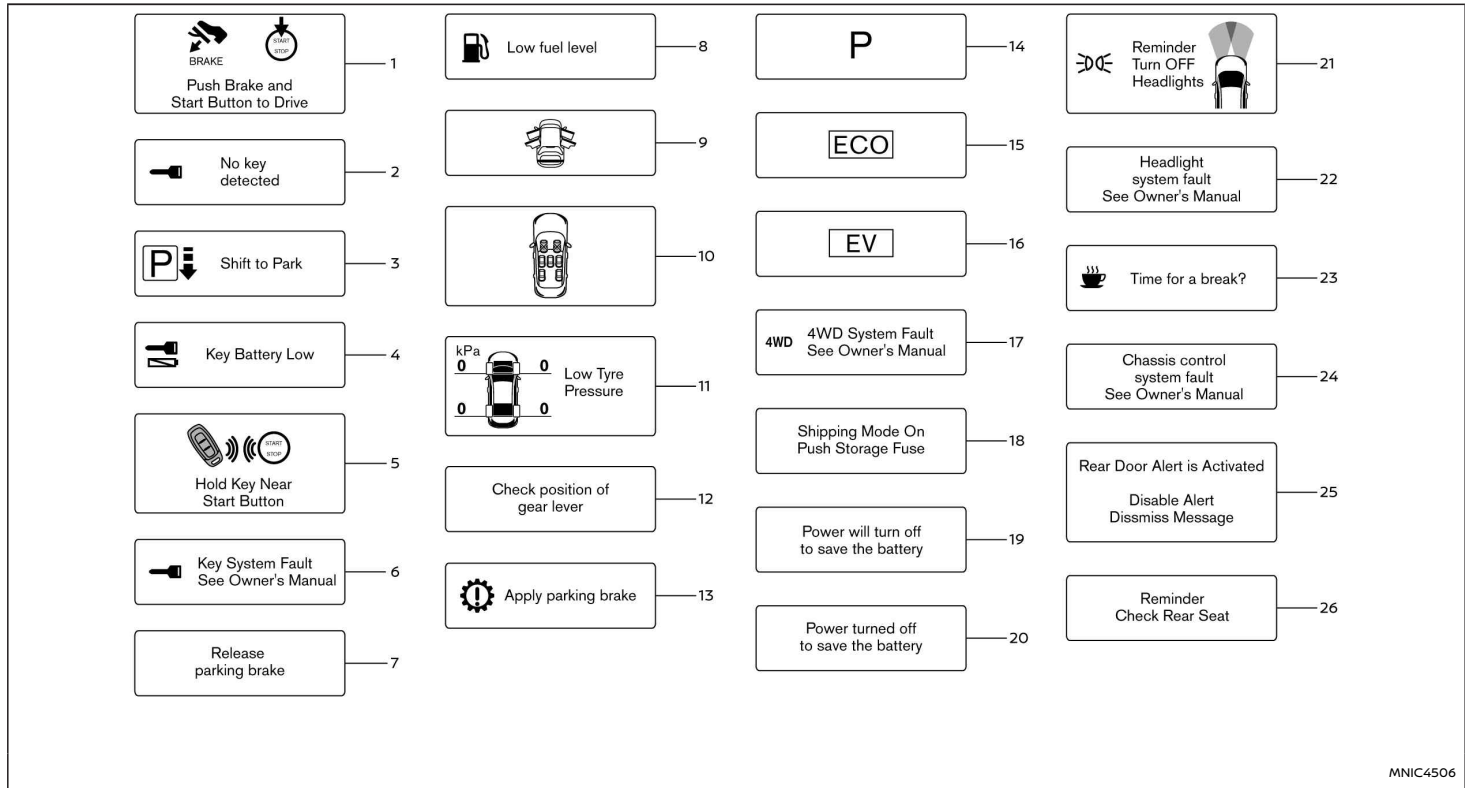
The I-Key Link can be turned ON/OFF using the scroll dial ①. It will display the key synchronized and in use for this vehicle.

Factory Reset











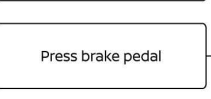








The settings in the vehicle information display can be reset back to the factory default. To reset the vehicle information display:

1. Select [Factory Reset] using the scroll dial ① and push it.
2. Select [Yes] to return all settings back to default by pushing the scroll dial ①.

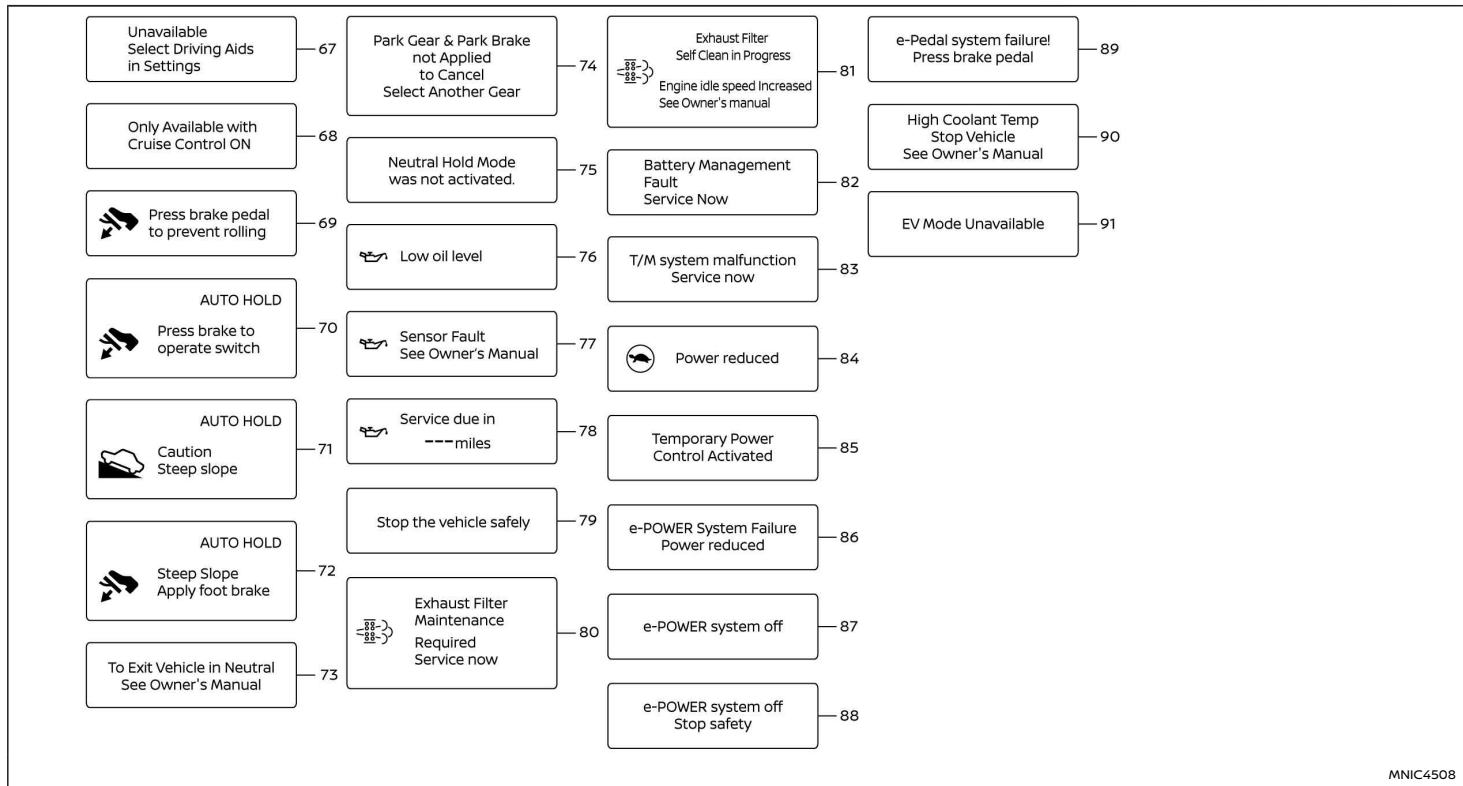
VEHICLE INFORMATION DISPLAY WARNINGS AND INDICATORS



MNIC4506

	27		36	Unavailable Low Visibility	45		53	Not Available, Parking Brake On	60
	28	System fault See Owner's Manual	37	Not Available Visibility is impaired	46		54		61
	29	Currently Unavailable	38	Temporarily Disabled Front Radar Blocked See Owner's Manual	47		55		62
	30	Currently Not Available	39	Temporarily Disabled Front Radar Blocked	48		56		63
	31	Currently Unavailable ESP OFF	40	Currently Unavailable Radar Inhibited	49	Press brake pedal	57	Parking sensor system fault See Owner's Manual	64
	32	Currently Unavailable Front Camera High Temperature	41	Temporarily Disabled Side Radar Blocked See Owner's Manual	50	Unavailable Slippery Road	58		65
	33	Unavailable Camera Temperature High	42	Not Available Side Radar Obstructed	51	Not Available, Seat Belt Not Fastened	59	<input type="checkbox"/> OK to Accept Speed Warning	66
	34	Currently Unavailable Poor Visibility	43		52	Steering Assist Not Available Cannot Detect Lane			
	35	Temporarily Disabled Camera Blocked See Owner's Manual	44						

MNIC4507



MNIC4508

The displayed images may differ depending on the model.

1. e-POWER system start operation indicator

This indicator appears when the shift position is in the P (Park) position.

This indicator means that the e-POWER system will start by pushing the power switch with the brake pedal depressed. You can start the e-POWER system directly in any position of the power switch.

2. [No key detected] warning

This warning appears when the door is closed with the Intelligent Key left outside the vehicle and the e-POWER system is running. Make sure that the Intelligent Key is inside the vehicle.

See "Intelligent Key system" (P.160) for more details.

3. Shift to Park warning

This warning appears alternately with the door/back door open warning when the driver's door is opened with the shift position in any position other than the P (Park) position.

If this warning appears, push the P position switch to engage the P (Park) position.

An inside warning chime will also sound. (See "Intelligent Key system" (P.160).)

4. [Key Battery Low] warning

This warning appears when the Intelligent Key battery is running out of power.

If this indicator appears, replace the battery with a new one. See "Intelligent Key battery" (P.439).

5. Engine start operation for Intelligent Key system indicator

This indicator appears when the Intelligent Key battery is running out of power and when the Intelligent Key system and vehicle are not communicating normally.

If this indicator appears, touch the power switch with the Intelligent Key while depressing the brake pedal. (See "Intelligent Key battery discharge" (P.237).)

6. [Key System Fault See Owner's Manual] warning

This warning appears if there is a malfunction in the Intelligent Key system.

If this warning appears while the e-POWER system is stopped, the e-POWER system cannot be started. If this warning appears while the e-POWER system is running, the vehicle can be driven. However, it is recommended that you visit a NISSAN dealer or qualified workshop for repair as soon as possible.

7. [Release parking brake] warning

This warning appears when the accelerator pedal is depressed when the electronic parking brake automatic release function cannot be used. Release the electronic parking brake manually.

8. [Low fuel level] warning

This warning appears when the fuel level in the fuel tank is getting low. Refuel as soon as it is convenient, preferably before the fuel gauge

reaches 0 (Empty). There will be a small reserve of fuel in the tank when the fuel gauge needle reaches 0 (Empty).

9. Door/back door open warning

This warning appears if any of the doors and/or the back door are open or not closed securely. The vehicle icon indicates which door or the back door is open on the display.

10. Seat belt warning

This warning appears after the power switch is placed in the ON position, until the seat belt is fastened.

For the driver's seat, if the buckle is fastened, the corresponding graphic will appear green. If the buckle is not fastened, the corresponding graphic will appear red. For front passenger's and rear seats, if there is no occupant on the seat, the corresponding seat belt graphic will appear grey. When one of the seats has been seated with passenger, if the buckle is fastened, the corresponding seat belt graphic will appear green. If the buckle is not fastened or is changed from buckled to unbuckled, the corresponding seat belt graphic will appear red. If this occurs while the vehicle speed exceeds 15 km/h (approximately 10 MPH), a buzzer will sound. When certain objects are placed on the front passenger's seat and/or rear seats, they may cause the warning to turn on.

For precautions on seat belt usage, see "Seat belts" (P.38).

11. [Low Tyre Pressure] warning

This warning appears when the low tyre pressure warning light in the meter illuminates and low tyre pressure is detected. The warning appears each time the power switch is placed in the ON position as long as the low tyre pressure warning light remains illuminated. If this warning appears, stop the vehicle and adjust the pressure to the recommended COLD tyre pressure shown on the tyre placard. (See "Low tyre pressure warning light" (P.87) and "Tyre Pressure Monitoring System (TPMS)" (P.231).)

12. [Check position of gear lever] warning

This warning appears when the shift lever is held in a position other than the centre position.

Make sure that the shift lever is placed in the centre position. If the warning appears when the shift lever is placed in the centre position, contact a NISSAN dealer or qualified workshop immediately.

13. [Apply parking brake] warning

This warning appears if a malfunction occurs in the electric shift control system. Contact a NISSAN dealer or qualified workshop as soon as possible. When parking the vehicle, make sure that the parking brake is applied. If the parking brake is not applied, the power switch may not be turned off.

14. Shift position indicator

This indicator shows the shift position when the power switch is in the ON position.

See "Electric shift control system" (P.240).

15. Drive Mode Selector indicator

When a driving mode is selected using the Drive Mode Selector, the selected mode indicator is displayed.

- [OFF-ROAD] (4WD models)
- [SNOW] (4WD models)
- [STANDARD]
- [ECO]
- [SPORT]

(See "Drive Mode Selector" (P.238).)

16. EV mode indicator

The EV mode indicator appears when the EV mode is selected.

(See "EV mode" (P.11).)

17. [4WD System Fault See Owner's Manual] warning (where fitted)

This warning appears when the Four-Wheel Drive (4WD) system is not functioning properly while the e-POWER system is running. Reduce vehicle speed and have your vehicle checked as soon as possible. It is recommended that you visit a NISSAN dealer or qualified workshop for this service. (See "Four-Wheel Drive (4WD) (where fitted)" (P.244).)

18. [Shipping Mode On Push Storage Fuse] warning (where fitted)

This warning may appear if the extended storage switch is not pushed in. When this warning appears, push in the extended storage switch to turn off the warning. (See "Extended storage switch (where fitted)" (P.443).)

19. [Power will turn off to save the battery] warning

Under the specific conditions, this warning may appear after the power switch is in the ON position for a certain period of time.

20. [Power turned off to save the battery] warning

Under the specific conditions, this warning may appear after the power switch is automatically turned OFF to save the 12-volt battery.

21. [Reminder Turn OFF Headlights] warning

This warning appears when the driver side door is opened with the headlight switch is left ON and the power switch is placed in the OFF position. Place the headlight switch in the "AUTO" position. For additional information, (See "Headlight and turn signal switch" (P.120).)

22. [Headlight system fault See Owner's Manual] warning

This warning appears if the LED headlights are malfunctioning. Have the system checked. It is recommended that you visit a NISSAN dealer or qualified workshop for this service.

23. [Time for a break?] indicator

This indicator appears when the set Timer Alert activates. You can set the time for up to 6 hours.

24. [Chassis control system fault See Owner's Manual] warning

This warning appears if the chassis control module detects a malfunction in the chassis control system. Have the system checked. It is recommended that you visit a NISSAN dealer or qualified workshop for this service. (See "Chassis control" (P.374).)

25. [Rear Door Alert is Activated] indicator (where fitted)

When the system is enabled, this message appears when the Rear Door Alert system is active and can remind the driver to check the rear seat.

- Using the steering switch, the driver can select [Dismiss Message] to clear the display for a period of time.
- Using the steering switch, the driver can select [Disable Alert] to disable the horn alert and the message for the remainder of the current trip.

For additional information, see "Rear Door Alert (Where fitted)" (P.133).

WARNING

Selecting [Dismiss Message] during a stop within a trip temporarily dismisses the message for that stop without turning the system off. Alerts can be provided for other stops during the trip. Selecting [Disable Alert] turns off the Rear Door Alert system for the remainder of a trip and no audible alert will be provided.

NOTE:

This system is disabled until the driver enables it using the settings menu. See "Vehicle Settings" (P.97).

26. [Reminder Check Rear Seat] indicator (where fitted)

When the system is enabled, this message appears when the vehicle comes to a complete stop, the shift position is placed from the D (Drive) to P (Park), and the driver exits the vehicle. This message alerts the driver, after a period of time, to check for items in the rear seat after the audible alert has been provided.

NOTE:

This system is disabled until the driver enables it using the settings menu. See "Vehicle Settings" (P.97).

27–28. Traffic Sign Recognition (TSR) system indicators (where fitted)

These indicators show the status of the Traffic Sign Recognition (TSR) system. The status is shown by the colour. (See "Traffic Sign Recognition (TSR) (where fitted)" (P.257).)

29. Emergency Lane Assist (ELA) indicator (where fitted)

This indicator appears when the following systems (where fitted) are engaged.

- Emergency Lane Assist (ELA)

For the ELA system, this indicator also appears when the power switch is placed in the ON position. It turns off after the e-POWER system is started.

(See "Emergency Lane Assist (ELA) (where fitted)" (P.263).)

30. Emergency Lane Assist (ELA) OFF indicator (where fitted)

This indicator appears when the Emergency Lane Assist (ELA) system is turned off. (See "Emergency Lane Assist (ELA) (where fitted)" (P.263).)

31. Blind Spot Warning (BSW)/Intelligent Blind Spot Intervention indicator (where fitted)

This indicator appears when the Blind Spot Warning (BSW) and/or Intelligent Blind Spot Intervention (where fitted) systems are engaged.

(See "Blind Spot Warning (BSW) (where fitted)" (P.270) or "Intelligent Blind Spot Intervention (where fitted)" (P.276).)

32. Vehicle ahead detection indicator (where fitted)

This indicator shows the status of the following systems:

- Intelligent Emergency Braking with Pedestrian Detection
- Intelligent Forward Collision Warning (See "Conventional (fixed speed) cruise control mode" (P.306) or "Conventional (fixed speed) cruise control mode" (P.336).)

33. Cruise indicator (where fitted)

Models without Intelligent Cruise Control (ICC) system:

This indicator shows the cruise control system status. The status is shown by the colour.

(See "Cruise control (where fitted)" (P.291).)

Models with Intelligent Cruise Control (ICC) system:

This indicator shows the conventional (fixed speed) cruise control mode status. The status is shown by the colour.

(See "Intelligent Cruise Control (ICC) (where fitted)" (P.293) or "Intelligent Cruise Control (ICC)" (P.319).)

34. Intelligent Cruise Control (ICC) system status indicator (where fitted)

This indicator shows the status of the Intelligent Cruise Control (ICC) system (without ProPILOT Assist system). The status is shown by the colour and shape.

(See "Intelligent Cruise Control (ICC) (where fitted)" (P.293).)

35. Speed control status/set distance/lane marker indicator (where fitted)

This indicator shows the status of the Intelligent Cruise Control (ICC) system and the detection of the lane markers. The status is shown by the colour and shape. (See "ProPILOT Assist (where fitted)" (P.309).)

36. Intelligent Blind Spot Intervention ON/ProPILOT Assist system status indicator (where fitted)

This indicator appears when the following systems (where fitted) are turned on:

- Intelligent Blind Spot Intervention
- ProPILOT Assist

See "Intelligent Blind Spot Intervention (where

fitted)" (P.276) or "ProPILOT Assist (where fitted)" (P.309).

37. [System fault See Owner's Manual] warning (where fitted)

This warning appears when the following systems (where fitted) malfunction.

- Traffic Sign Recognition (TSR)
- Rear Automatic Braking (RAB)
- Rear Cross Traffic Alert (RCTA)
- Intelligent Emergency Braking with Pedestrian Detection
- Intelligent Forward Collision Warning
- Emergency Lane Assist (ELA)
- Blind Spot Warning (BSW)
- Intelligent Blind Spot Intervention
- Intelligent Cruise Control (ICC)
- ProPILOT Assist
- Steering Assist
- Intelligent Driver Alertness

(See "Traffic Sign Recognition (TSR) (where fitted)" (P.257), "Rear Automatic Braking (RAB) (where fitted)" (P.358), "Rear Cross Traffic Alert (RCTA) (where fitted)" (P.284), "Intelligent Emergency Braking with Pedestrian Detection system" (P.338), "Intelligent Forward Collision Warning (where fitted)" (P.348), "Emergency Lane Assist (ELA) (where fitted)" (P.263), "Blind Spot Warning (BSW) (where fitted)" (P.270), "Intelligent Blind Spot Intervention (where fitted)" (P.276), "Intelligent Cruise Control (ICC) (where fitted)" (P.293), "ProPILOT Assist (where fitted)" (P.309), "Steering Assist" (P.331) or "Intelligent Driver Alertness (where fitted)" (P.355).)

38. [Currently Unavailable] warning (where fitted)

This warning appears under the following conditions when the Traffic Sign Recognition (TSR) system or the Intelligent Emergency Braking with Pedestrian Detection system is activated.

For the TSR system:

- When the data communication between systems is temporarily interrupted

For the Intelligent Emergency Braking with Pedestrian Detection system:

- When the system check for the warning function did not end normally
- When the vehicle is towed

(See "Traffic Sign Recognition (TSR) (where fitted)" (P.257) or "Intelligent Emergency Braking with Pedestrian Detection system" (P.338).)

39. [Currently Not Available] warning (where fitted)

This warning appears when the Intelligent Blind Spot Intervention (where fitted) or the Intelligent Cruise Control (ICC) system (where fitted) becomes unavailable in the following conditions:

- The Electronic Stability Programme (ESP) system is turned off.
- The SNOW mode or the OFF-ROAD mode is selected (4WD models).

This warning also appears when the Emergency Lane Assist (ELA) (where fitted) becomes unavailable when the direction of the front camera is significantly misaligned.

For additional information, refer to "Intelligent Blind Spot Intervention (where fitted)" (P.276),

"Intelligent Cruise Control (ICC) (where fitted)" (P.293), "Intelligent Cruise Control (ICC)" (P.319) or "Emergency Lane Assist (ELA) (where fitted)" (P.263).

40. [Currently Unavailable ESP OFF] warning (where fitted)

This warning appears when the Electronic Stability Programme (ESP) system is turned off with the following systems activated:

- Emergency Lane Assist (ELA)
- Intelligent Emergency Braking with Pedestrian Detection

(See "Emergency Lane Assist (ELA) (where fitted)" (P.263) or "Intelligent Emergency Braking with Pedestrian Detection system" (P.338).)

41. [Currently Unavailable Front Camera High Temperature] warning (where fitted)

This warning appears if the interior temperature of the vehicle has reached such a high temperature that the sensor for the following systems (where fitted) can no longer function reliably.

- Traffic Sign Recognition (TSR)
- Emergency Lane Assist (ELA)
- Intelligent Emergency Braking with Pedestrian Detection

Once the interior temperature has reached normal levels, the warning should disappear.

If the warning continues to display, have the system checked. It is recommended that you visit a NISSAN dealer or qualified workshop for this service.

(See "Traffic Sign Recognition (TSR) (where fitted)"

(P.257), "Emergency Lane Assist (ELA) (where fitted)" (P.263) or "Intelligent Emergency Braking with Pedestrian Detection system" (P.338).)

42. [Unavailable Camera Temperature High] warning (where fitted)

This warning appears if the interior temperature of the vehicle has reached such a high temperature that the sensor for the following systems (where fitted) can no longer function reliably.

- Intelligent Blind Spot Intervention
- Steering Assist

Once the interior temperature has reached normal levels, the warning should disappear.

If the warning continues to display, have the system checked. It is recommended that you visit a NISSAN dealer or qualified workshop for this service.

For additional information, refer to "Intelligent Blind Spot Intervention (where fitted)" (P.276) or "Steering Assist" (P.331).

43. [Currently Unavailable Poor Visibility] warning (where fitted)

This warning appears when the Intelligent Emergency Braking with Pedestrian Detection system is activated and strong light, such as sunlight or high beams from oncoming vehicles, enter the front camera.

(See "Intelligent Emergency Braking with Pedestrian Detection system" (P.338).)

44. [Temporarily Disabled Camera Blocked See Owner's Manual] warning (where fitted)

This warning appears when the Traffic Sign Recognition (TSR) system, the Emergency Lane Assist (ELA) system and/or the Intelligent Emergency Braking with Pedestrian Detection system is turned off automatically under the following conditions:

- The camera area of the windscreen is covered with moisture, snow, ice, dirt or some other object
- The camera area of the windscreen is continuously covered with dirt, etc.

Clean the windscreen glass of the camera area. Use the wipers and the defogger to help clear the windscreen glass.

(See "Traffic Sign Recognition (TSR) (where fitted)" (P.257), "Emergency Lane Assist (ELA) (where fitted)" (P.263) or "Intelligent Emergency Braking with Pedestrian Detection system" (P.338).)

45. [Unavailable Low Visibility] indicator (where fitted)

This message may appear when the Steering Assist system is engaged.

Under the following conditions, the Steering Assist system is automatically cancelled:

- The camera area of the windscreen is fogged up or covered with dirt, water, drops, ice, snow, etc.
- Strong light, such as sunlight or high beams from oncoming vehicles, enter the front camera

46. [Not Available Visibility is impaired] indicator (where fitted)

This message may appear when the Steering Assist system is engaged.

Under the following conditions, the Steering Assist system is automatically cancelled:

- When the wiper (HI) operates.
- When lane markers in the travelling lane cannot be correctly detected for a period of time due to such items as a snow rut, reflection of light on a rainy day or several unclear lane markers are present.

If you want to use the Steering Assist system again, cancel the ProPILOT Assist system and set it again when lane markers are clearly visible.

47. [Temporarily Disabled Front Radar Blocked See Owner's Manual] warning (where fitted)

If the front radar sensor area on the front of the vehicle is covered with dirt or obstructed, making it impossible to detect a vehicle ahead, the following systems (where fitted) automatically turned off.

- Emergency Lane Assist (ELA)
- Intelligent Emergency Braking with Pedestrian Detection
- Intelligent Forward Collision Warning

If the warning message appears, park the vehicle in a safe location and turn the e-POWER system off.

Check to see if the sensor area is blocked. If the sensor area is blocked, remove the blocking material. Restart the e-POWER system. If the warning message continues to appear, have the system checked. It is recommended that you visit a

NISSAN dealer or qualified workshop for this service.

(See "Emergency Lane Assist (ELA) (where fitted)" (P.263), "Intelligent Emergency Braking with Pedestrian Detection system" (P.338) or "Intelligent Forward Collision Warning (where fitted)" (P.348).)

48. [Temporarily Disabled Front Radar Blocked] warning (where fitted)

If the front radar sensor area on the front of the vehicle is covered with dirt or obstructed, making it impossible to detect a vehicle ahead, the following systems (where fitted) automatically turned off.

- Intelligent Cruise Control (ICC)
- ProPILOT Assist

If the warning message appears, park the vehicle in a safe location and turn the e-POWER system off.

Check to see if the sensor area is blocked. If the sensor area is blocked, remove the blocking material. Restart the e-POWER system. If the warning message continues to appear, have the system checked. It is recommended that you visit a NISSAN dealer or qualified workshop for this service.

For more details, see "Intelligent Cruise Control (ICC) (where fitted)" (P.293), "ProPILOT Assist (where fitted)" (P.309), "Intelligent Emergency Braking with Pedestrian Detection system" (P.338) or "Intelligent Forward Collision Warning (where fitted)" (P.348).

49. [Currently Unavailable Radar Inhibited] warning (where fitted)

This warning appears when the front radar sensor for the Intelligent Emergency Braking with Pedestrian Detection system and Intelligent Forward Collision Warning system pick up interference from another radar source.

(See "Intelligent Emergency Braking with Pedestrian Detection system" (P.338) and "Intelligent Forward Collision Warning (where fitted)" (P.348).)

50. [Temporarily Disabled Side Radar Blocked See Owner's Manual] warning (where fitted)

This warning appears when the Emergency Lane Assist (ELA) system becomes unavailable because a radar blockage is detected.

(See "Emergency Lane Assist (ELA) (where fitted)" (P.263).)

51. [Not Available Side Radar Obstructed] warning (where fitted)

This warning appears when the following systems (where fitted) become unavailable because a radar blockage is detected.

- Blind Spot Warning (BSW)
 - Intelligent Blind Spot Intervention
 - Rear Cross Traffic Alert (RCTA)
- (See "Intelligent Blind Spot Intervention (where fitted)" (P.276), "Blind Spot Warning (BSW) (where fitted)" (P.270) or "Rear Cross Traffic Alert (RCTA) (where fitted)" (P.284).)

52. Steering Assist indicator (where fitted)

This indicator appears when the Steering Assist system is engaged.

See "ProPILOT Assist (where fitted)" (P.309).

53-55. Hands on detection warning (where fitted)

This warning may appear when the Steering Assist system is engaged and the following condition(s) occur:

- When not holding the steering wheel
- When there is no steering wheel operation

Hold on the steering wheel immediately. When the steering operation is detected, the warning turns off and the Steering Assist function is automatically restored. For additional information, refer to "ProPILOT Assist (where fitted)" (P.309).

56. [Press brake pedal] indicator (where fitted)

This message may appear when the ProPILOT Assist system is engaged and the following condition occurs:

- While the vehicle is stopped by the ProPILOT Assist system, the driver's door is opened but the electronic parking brake was not activated.

Step on the brake pedal immediately.

57. [Unavailable Slippery Road] warning (where fitted)

This warning appears when the following systems (where fitted) become unavailable because the road is slippery.

- Intelligent Blind Spot Intervention
- Intelligent Cruise Control (ICC)
- ProPILOT Assist

(See "Intelligent Blind Spot Intervention (where fitted)" (P.276), "Intelligent Cruise Control (ICC) (where fitted)" (P.293) or "Intelligent Cruise Control (ICC)" (P.319).)

58. [Not Available, Seat Belt Not Fastened] indicator (where fitted)

This message may appear when the ProPILOT Assist system is engaged.

Under the following condition, the ProPILOT Assist system is automatically cancelled:

- When the driver's seat belt is not fastened.

The ProPILOT Assist system cannot be used when the driver's seat belt is not fastened.

59. [Steering Assist Not Available Cannot Detect Lane] indicator (where fitted)

This indicator may appear when the Steering Assist system is engaged. The Steering Assist system is automatically cancelled when the lane markers in the travelling lane cannot be correctly detected for a period of time due to such items as a snow rut, reflection of light on a rainy day or several unclear lane markers are present.

If you want to use the Steering Assist system again, cancel the ProPILOT Assist system and set it again when lane markers are clearly visible.

60. [Not Available, Parking Brake On] indicator (where fitted)

This message may appear when the ProPILOT Assist system is engaged.

Under the following condition, the ProPILOT Assist system is automatically cancelled:

- The electronic parking brake is applied.

The above system cannot be used when the electronic parking brake is activated.

61. Intelligent Emergency Braking emergency warning indicator (where fitted)

This warning indicator appears along with an audible warning, when the Intelligent Emergency Braking with Pedestrian Detection system detects the possibility of a forward collision.

See "Intelligent Emergency Braking with Pedestrian Detection system" (P.338).

62. Rear Automatic Braking (RAB) system warning indicator (where fitted)

This warning indicator appears to indicate the status of the Rear Automatic Braking (RAB) system.

See "Rear Automatic Braking (RAB) (where fitted)" (P.358).

63. Parking sensor (sonar) system indicator (where fitted)

This indicator appears to indicate the status of the parking sensor (sonar) system.

See "Parking sensor (sonar) system" (P.377).

64. [Parking sensor system fault See Owner's Manual] warning (where fitted)

This warning appears when there is a malfunction with the parking sensor (sonar) system. (See "Parking sensor (sonar) system" (P.377).)

65. [Take a break?] indicator (where fitted)

This indicator appears when the Intelligent Driver Alertness system detects that the driver attention is decreasing. (See "Intelligent Driver Alertness (where fitted)" (P.355).)

66. OK to Accept Speed Warning indicator (where fitted)

This indicator appears when the Traffic Sign Recognition (TSR) system sounds an overspeed warning chime. Slow down or push the scroll dial on the steering wheel to stop the warning chime. (See "Traffic Sign Recognition (TSR) (where fitted)" (P.257).)

67. [Unavailable Select Driving Aids in Settings] indicator (where fitted)

This indicator appears if neither the Intelligent Lane Intervention system nor the Intelligent Blind Spot Intervention system is enabled on the settings menu.

68. [Only Available with Cruise Control ON indicator] (where fitted)

This indicator appears when the Steering Assist switch is pushed while the Intelligent Cruise Control (ICC) system is not turned on. (See "ProPILOT Assist (where fitted)" (P.309).)

69. [Press brake pedal to prevent rolling] warning

This warning appears in the following situations:

- The driver tries to release the electronic parking brake manually without depressing the brake pedal.
- The vehicle is stopped on a steep hill and there is a possibility of moving backward, even if the electronic parking brake is applied.
- This warning appears and chime sounds if the vehicle moves while Automatic brake hold function is activated. Apply the footbrake to stop the vehicle moving.

70. [Press brake to operate switch] indicator

This indicator appears if Automatic brake hold switch is pushed without depressing the brake pedal while the automatic brake hold function is activated. Depress the brake pedal and push the switch to deactivate Automatic brake hold function. (See "Automatic brake hold" (P.191).)

71. [Caution Steep slope] indicator

This indicator appears and chime sounds when Automatic brake hold function is activated while the vehicle is on a steep hill. Apply the footbrake to stop the vehicle moving. (See "Automatic brake hold" (P.191).)

72. [Steep Slope Apply footbrake] indicator

This indicator appears and chime sounds if [Caution Steep slope] indicator has appeared over about 3 minutes. Then, the parking brake will automatically be applied and the brake force of the automatic brake hold will be released, and

vehicle may move or roll away unexpectedly. Apply the footbrake to stop the vehicle moving. (See "Automatic brake hold" (P.191).)

73. Neutral Hold Mode guidance indicator (where fitted)

This indicator appears when the power switch is placed in the OFF position while the shift position is in the N (Neutral) position (Neutral hold mode is available). (See "Neutral hold mode function (where fitted)" (P.243).)

74. Neutral Hold Mode activated indicator (where fitted)

This indicator appears when the Neutral hold mode is activated. To exit the Neutral hold mode, place the vehicle in other than N (Neutral) position. (See "Neutral hold mode function (where fitted)" (P.243).)

75. [Neutral Hold Mode was not activated.] indicator (where fitted)

This indicator appears when the Neutral hold mode is unavailable. To activate the Neutral hold mode, wait for a while without shifting and then perform the operations again. (See "Neutral hold mode function (where fitted)" (P.243).)

76. [Low oil level] warning

This warning appears when the engine oil level is low. Warm up the engine on a level surface. After at least 10 minutes have passed since the engine was stopped, use the engine oil dipstick to check the oil level. (See "Engine oil" (P.430).) If the oil level is low, add the engine oil or change the engine oil.

If the warning appears again before reaching the oil change interval shown in a separate maintenance booklet check the oil level. When the

warning appears and the oil level is low, have the vehicle checked. It is recommended that you visit a NISSAN dealer or qualified workshop for this service.

NOTE:

If the vehicle is not on a level surface, accurate measurement of the oil level may not be possible. If [Low oil level] warning message appears, but the level shown by the oil dipstick is normal, move the vehicle to a level surface and stop the e-POWER system. After at least 10 minutes have passed, open the driver's door and place the power switch in the ON position. If the [Low oil level] warning message appears again, add the engine oil or change the engine oil, according to the instructions described above.

77. [Sensor Fault See Owner's Manual] warning

This warning appears when the engine oil level sensor may be malfunctioning. It is recommended you contact a NISSAN dealer or qualified workshop immediately.

78. Engine Oil [Service due in] - - - km (mile) indicator

This distance to oil change is displayed if the distance to oil change is less than 100 km (62 miles).

79. [Stop the vehicle safely] warning (where fitted)

This warning appears when the electric shift control system judges the vehicle is reversed on an uphill road with the shift position in D (Drive), or moved forward on a downhill road with the shift position in R (Reverse). The engine may stall, so

stop the vehicle movement by depressing the brake pedal.

80-81. Exhaust Filter indicator (where fitted)

These messages will appear when the Petrol Particulate Filter (GPF) becomes saturated or clogged. Under certain driving conditions, automatic regeneration of the filter may be difficult to occur. See Petrol Particulate Filter (GPF) or contact a NISSAN dealer or qualified workshop.

82. [Battery Management Fault Service Now] warning

This warning appears when the battery system may be malfunctioning. Have the system checked. It is recommended that you visit a NISSAN dealer or qualified workshop for this service.

83. [T/M system malfunction Service now] warning

This warning appears if a malfunction occurs in the electric shift control system.

Contact a NISSAN dealer or qualified workshop as soon as possible.

Since the shift position may not be switched immediately, hold the shift lever in that position and confirm that the shift position has been switched, and then release the shift lever.

If the vehicle does not automatically apply the P (Park) position when the power switch is placed in the OFF position, push the P position switch when parking the vehicle, and then confirm that the shift position indicator is P in the vehicle information display.

84. [Power reduced] warning (where fitted)

This warning appears when the power limitation indicator light illuminates. If this warning appears, vehicle speed will not increase due to the power limitation even if the accelerator pedal is depressed.

This warning will also appear if the accelerator pedal is depressed when the vehicle is stopped and the shift lever is placed in the N (Neutral) position. In this case, release the accelerator pedal.

85. Temporary Power Control Activated warning (where fitted)

This warning appears when the power limitation indicator light illuminates. If this warning appears, vehicle speed will not increase due to the power limitation even if the accelerator pedal is depressed.

This warning will also appear if the accelerator pedal is depressed when the vehicle is stopped and the shift lever is placed in the N (Neutral) position. In this case, release the accelerator pedal.

86. [e-Power System Failure Power reduced] warning

This warning appears if there is a malfunction in the e-POWER system and the power provided to the electric motor is reduced.

The displayed message will vary depending on the condition of the system malfunction. Be sure to follow the displayed instruction.

87. [e-Power system off] warning

This warning appears if the Lithium ion (Li-ion) battery is malfunctioning and a danger of the Li-ion battery thermal runaway is detected when the vehicle is stopped.

Leave the vehicle and contact a NISSAN dealer or qualified workshop.

88. [e-Power system off Stop safely] warning

This warning appears if the Lithium ion (Li-ion) battery is malfunctioning and a danger of the Li-ion battery thermal runaway is detected while driving.

Pull off the road to a safe location immediately, leave the vehicle and contact a NISSAN dealer or qualified workshop.

89. [e-Pedal system failure! Press brake pedal] warning

This warning appears when the e-Pedal Step system is malfunctioning. Have the system checked soon at a NISSAN dealer or qualified workshop.

90. [High Coolant Temp Stop Vehicle See Owner's Manual] warning

This warning appears when the engine coolant temperature is extremely high.

CAUTION

- **If this warning appears when the power switch is in the ON position, stop the vehicle safely as soon as possible.**
- **If the vehicle is overheated, continuing**

vehicle operation may seriously damage the engine. (See "If your vehicle overheats" (P.409) for the immediate action required.)

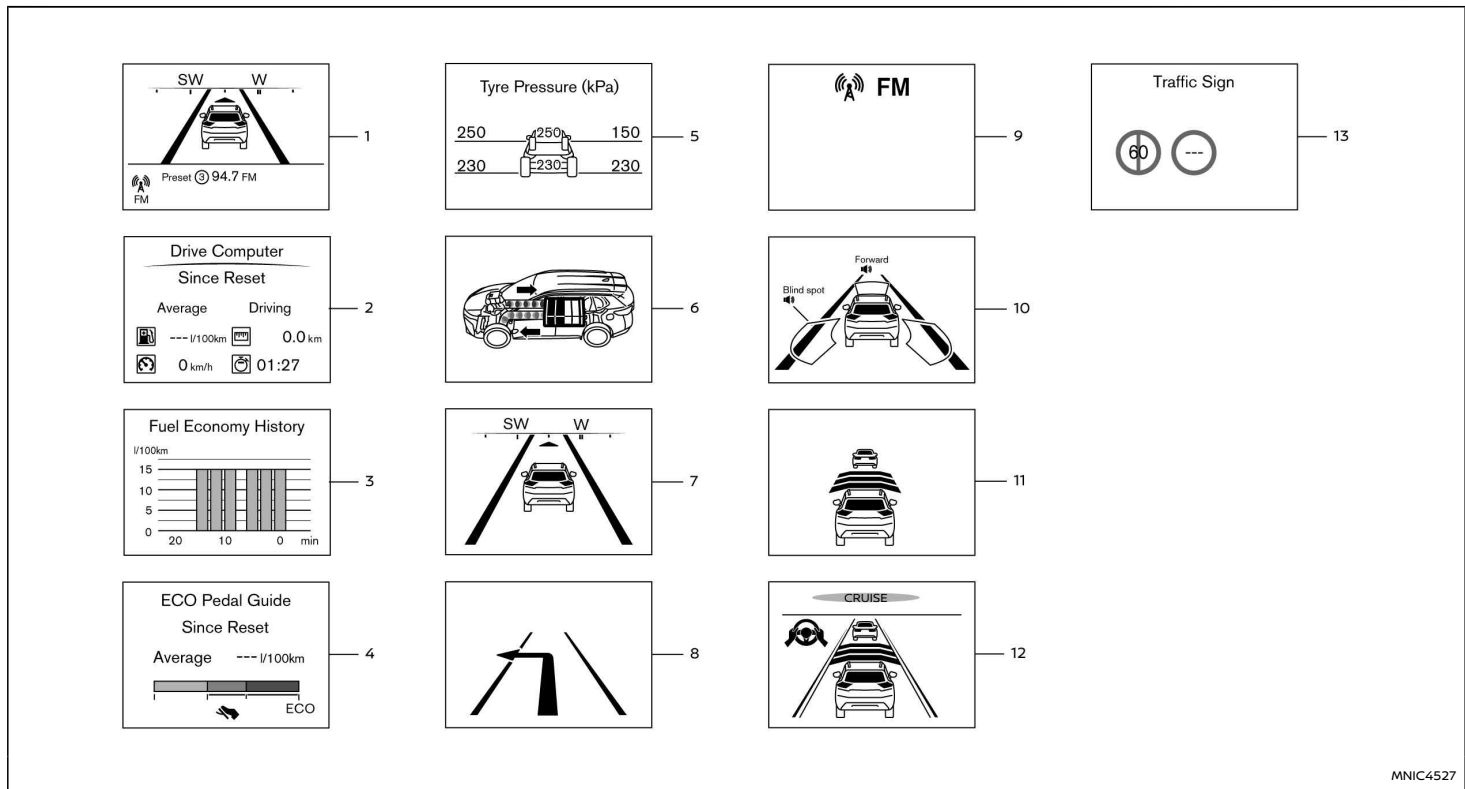
91. [EV Mode Unavailable] warning

This warning appears when the EV mode is not under operating conditions.

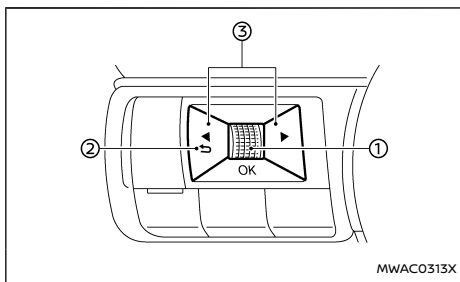
The displayed message will vary depending on the condition of the system.

To use the EV mode, correct the condition or wait until the warning disappears, and then push the EV mode switch. See "EV mode" (P.11).

TRIP COMPUTER



MNIC4527



Switches for the trip computer are located on the left side of the steering wheel.

- ① Scroll dial - navigate through the items and change or select an item in vehicle information display
this scroll dial allows up/down navigation and push to select
- ② ↶ - go back to the previous menu
- ③ ◀ ▶ - change from one display screen to the next (i.e. trip, Fuel economy)

The displayed images may differ depending on the model.

1. Home

The Home mode shows the following information.

- Vehicle speed
- Navigation (where fitted)
- Audio

2. [Drive Computer]

Average fuel consumption:

The average fuel consumption shows the average fuel consumption since the last reset.

Average speed:

The average speed shows the average vehicle speed since the last reset.

Trip odometer:

The trip odometer shows the total distance the vehicle has been driven since the last reset.

Elapsed time:

The elapsed time shows the time since the last reset.

The Drive Computer mode has three modes of operation. You can switch between Since Reset, Since Start or Since Refuel by pushing the scroll dial ①.

Since Reset can be reset manually by using the scroll dial ①.

Since Start will be reset automatically each time the e-POWER system is started.

Since Refuel will be reset automatically each time when refuelling.

3. Fuel Economy History

The Fuel Economy History mode shows the average fuel consumption at 2-minute intervals, in the past 20 minutes.

4. [ECO Pedal Guide]

When the ECO mode is selected, you can view the ECO Pedal Guide function for improving fuel economy.

(See "ECO Pedal Guide function" (P.240).)

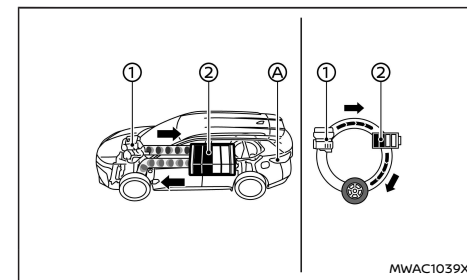
5. [Tyre Pressure]

The Tyre Pressure mode shows the pressure of all four tyres while the vehicle is driven.

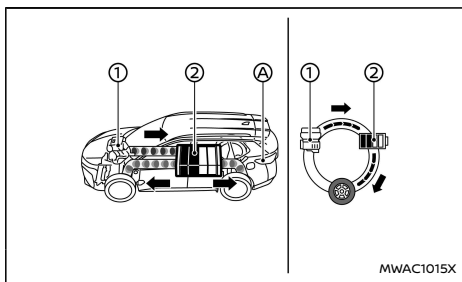
With the [Tyre ECO advice] function ON, when the tyre pressure is getting low, [ECO Advice Adjust Tyre Pressures] appears. (See "ECO Settings" (P.95) and "Tyre ECO advice (where fitted)" (P.240).)

When the Low Tyre Pressure warning appears, the display can be switched to the tyre pressure mode by pushing the scroll dial ① to reveal additional details on the displayed warning.

6. Energy Flow



2WD models



4WD models

The Energy Flow mode shows the current energy flow between engine, Lithium ion (Li-ion) battery and tyres.

- ① Engine
- ② Li-ion battery

The current energy status of the engine, Li-ion battery and Li-ion battery charge is shown by colour or illumination pattern as follows.

① Engine display colour	② Lithium ion (Li-ion) battery display colour
<p>Grey: When the fuel is not consumed.</p> <p>Orange: When the fuel is consumed.</p>	<p>Blue: The remaining battery level is normal.</p> <p>Yellow: The remaining battery level is low. (When the remaining battery level is low, less power may be provided to drive than usual.)</p>

NOTE:

- For the e-POWER system, the engine may also start when the power generator is not generating power. The Energy Flow is not

displayed when the electrical power is not generated.

- When the vehicle's brake lights come on, the brake lights $\text{\textcircled{A}}$ in the Energy Flow also come on.

The charge level display will continuously change as the Li-ion battery charge level increases or decreases during normal vehicle operation.

7. Compass (where fitted)

This display indicates the heading direction of the vehicle.

8. Navigation (where fitted)

When the route guidance is set in the navigation system, this item shows the navigation route information.

9. Audio

The Audio mode shows the status of audio information.

10. Driver Assistance (where fitted)

The Driver Assistance mode shows the operating condition for the following systems (where fitted).

- Forward:
 - Intelligent Emergency Braking with Pedestrian Detection
 - Intelligent Forward Collision Warning
- Lane:
- Blind Spot:
 - Blind Spot Warning (BSW)
 - Intelligent Blind Spot Intervention

For more details, see "Blind Spot Warning (BSW) (where fitted)" (P.270), "Intelligent Blind Spot Intervention (where fitted)" (P.276), "Intelligent Emergency Braking with Pedestrian Detection system" (P.338), "Intelligent Forward Collision Warning

(where fitted)" (P.348) or "Driver Assistance systems" (P.245).

11. Intelligent Cruise Control (ICC) (where fitted)

The Intelligent Cruise Control (ICC) mode shows the operating condition for the ICC system. (See "Intelligent Cruise Control (ICC) (where fitted)" (P.293).)

12. ProPILOT Assist (where fitted)

The ProPILOT Assist mode shows the operating conditions for the following systems:

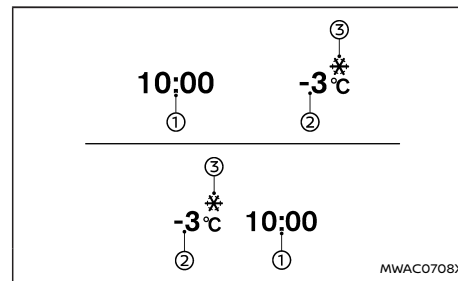
- Intelligent Cruise Control (ICC)
- Steering Assist

The display will also be shown when the ProPILOT Assist is turned on. For additional information, see "ProPILOT Assist (where fitted)" (P.309).

13. [Traffic Sign] (where fitted)

The Traffic Sign Recognition (TSR) system provides the driver with information about the most recently detected speed limit. See "Traffic Sign Recognition (TSR) (where fitted)" (P.257) for more details.

CLOCK AND OUTSIDE AIR TEMPERATURE



The clock ① and outside air temperature ② are displayed on the upper side of the vehicle information display.

Clock

For clock adjustment, see "Clock" (P.97) or the separate NissanConnect Owner's Manual (where fitted).

Outside air temperature (°C or °F)

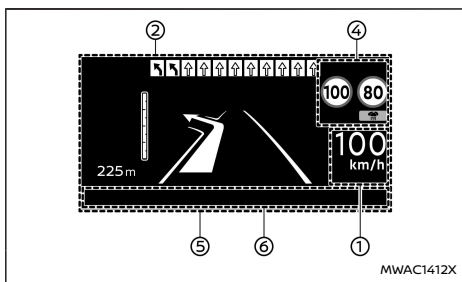
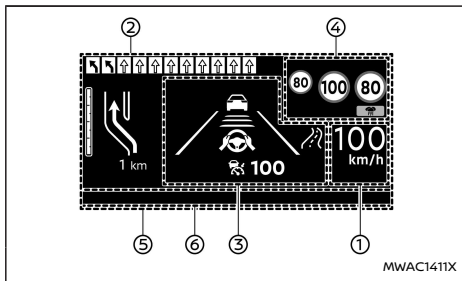
The outside air temperature is displayed in °C or °F in the range of -40 to 60°C (-40 to 140°F).

The outside air temperature mode includes a low temperature warning feature. If the outside air temperature is below -3°C (27°F), the indicator ③ is displayed.

The outside temperature sensor is located in front of the radiator. The sensor may be affected by road engine heat, wind directions and other driving conditions. The display may differ from

the actual outside temperature or the temperature displayed on various signs, billboards or media information.

HEAD UP DISPLAY (HUD) (where fitted)



⚠ WARNING

- Failure to properly adjust the brightness and position of the displayed image may interfere with the driver's ability to see through the windscreen, which could cause an accident leading to severe injury or death.
- Do not use the Head Up Display (HUD) for

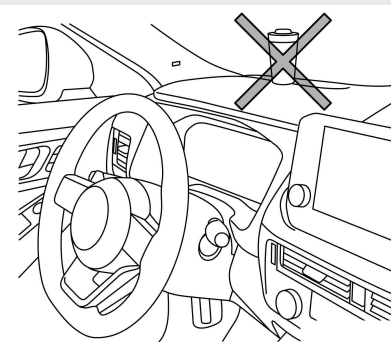
extended periods of time as that can cause you to not see other vehicles, pedestrians or objects, which could cause an accident leading to severe injury or death.

The Head Up Display (HUD) can display one or more of the following features (where fitted):

- ① Vehicle speed
- ② Navigation
- ③ Driving Assist
- ④ Traffic Sign
- ⑤ Audio
- ⑥ TEL/SMS

CAUTION

- Do not place any type of liquid on or near the projector. Doing so may cause malfunction of the equipment.



- Do not touch any internal parts of the

projector. Doing so may cause malfunction of the equipment.

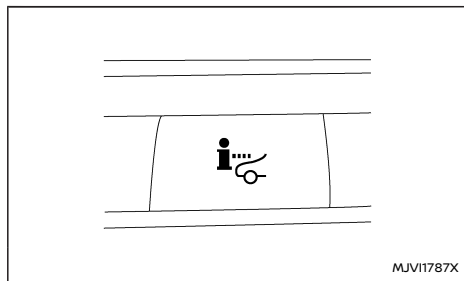
- To prevent scratches to the projector glass, do not place any sharp objects on or near the projector opening.
- Do not place any objects on the instrument panel which may obstruct the display of the HUD.
- For cleaning, use a soft clean dry cloth. If the dirt cannot be removed, use a soft clean cloth, dampened with water. Then wipe with a soft clean cloth. Never use a rough cloth, alcohol, benzene, thinner or any kind of solvent or paper towel with a chemical cleaning agent. They will scratch or cause discoloration to the projector lens.
- Do not spray any liquid such as water on the projector lens. Spraying liquid may cause the system to malfunction.

NOTE:

- If you wear polarised sunglasses, the display may be difficult to see. Increase the brightness of the HUD in the vehicle information display or remove your sunglasses.
- Depending on weather conditions (rain, snow, sunlight, etc.), the display may be difficult to see.
- If the displayed image appears distorted, it is recommended you have the system checked by a NISSAN dealer or qualified workshop.

- The HUD has a special windscreen to allow the image to be displayed clearly. If your windscreen needs replacing, this should be performed by a NISSAN dealer or qualified workshop.

HOW TO USE THE HUD



To turn the HUD on, push the HUD switch. To turn the HUD off, push the switch again.

If the HUD is turned off, it will remain off even if the vehicle is restarted.

The following settings can be changed in the vehicle information display:

- [Brightness]
- [Height]
- [Rotation]
- [Contents Selection]
 - [Navigation] (where fitted)
 - [Driving Aids]

- [Traffic Sign]
- [Audio]
- [Telephone]

- Reset

NOTE:

- If the HUD is turned off by the HUD switch, the [Head-Up Display] menu in the vehicle information display cannot be operated. To operate the [Head-Up Display] menu, push the HUD switch to turn on the HUD.
- Emergency information may display even if the HUD is turned off.

This product includes the following software.

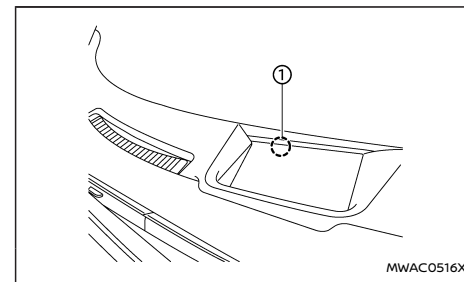
- (1) Panasonic Corporation or software developed for Panasonic Corporation
- (2) Third-party software licenced to Panasonic Corporation
- (3) Open source software

Regarding (3) Open source software, it includes open source software (OSS), including various software to which licence information applies.

Refer to the licence web site at: <http://car.panasonic.jp/oss/j03l1nna>

Display brightness

The brightness of the display may be controlled in the vehicle information display. The brightness will also be adjusted automatically according to the exterior ambient lighting brightness.



NOTE:

- The HUD has a built-in sensor ① that controls the brightness of the displayed image. If you block the sensor with an object, the display will darken, making it difficult to see.
- Do not apply strong light to the sensor of the HUD. Doing so may cause a malfunction.

DRIVING AIDS/NAVIGATION/TRAFFIC SIGN/AUDIO/TELEPHONE LINKING

The HUD will display Driving Aids and navigation (where fitted) information.

The Driving Aids display will show warning situations for the following systems (where fitted):

- Intelligent Emergency Braking with Pedestrian Detection
- Intelligent Forward Collision Warning
- Emergency Lane Assist (ELA)

HEADLIGHT AND TURN SIGNAL SWITCH

- Hands-free warning (for vehicles with ProPI-LOT Assist)

The Navigation System (where fitted) linking display will show the following items:

- Intersection names
- Arrows indicating turning direction
- Distance to the next intersection
- Recommended lane indicator

The Traffic Signs Recognition (TSR) system linking display will show the following items:

- Speed Limit Sign
- No Entry Sign

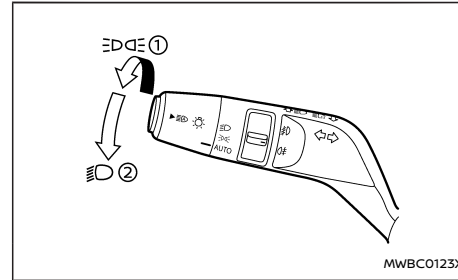
The Audio System linking display will show the following items:

- Songs
- Radio stations

The Telephone linking display will show the following item:

- Caller's name or phone number

HEADLIGHT SWITCH



Example

NISSAN recommends that you consult the local regulations concerning the use of lights.

☰ position

The ☰ position turns on the front clearance lights, instrument panel lights, tail and number plate lights.

☹ position

The ☹ position turns on the headlights in addition to the other lights.

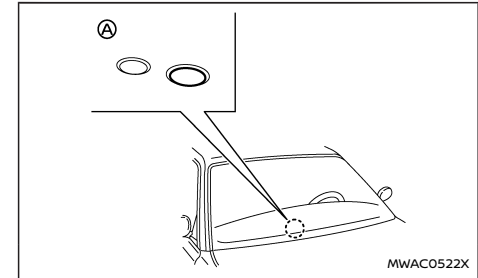
AUTO position

When the power switch is in the ON position and the headlight switch is in the "AUTO" position, the headlights, front clearance lights, instrument panel lights, tail and number plate lights turn on automatically depending on the brightness of the surroundings.

The headlights will turn on automatically at twi-

light or in rainy weather (when the windscreen wiper is operated continuously).

When the power switch is placed in the OFF position, the lights will turn off automatically.

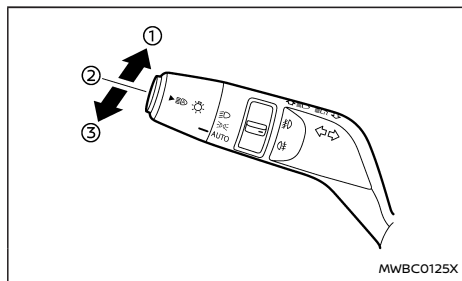


CAUTION


Do not place any objects on top of the sensor
 Ⓐ. The sensor senses the brightness level and controls the Intelligent Auto Headlight function. If the sensor is covered, it reacts as if it is dark, and the headlights will illuminate.

The layout in the illustration is for the Left-Hand Drive (LHD) model. For the Right-Hand Drive (RHD) model, the sensor is located on the opposite side.

Headlight beam



Example

- ① To select the high beam, push the lever forward and release it. The high beam lights come on and the  light illuminates.
- ② Pull the lever back and release it to select the low beam.
- ③ To flash the headlights when the high beam is not selected, pull the lever towards the rear position. To flash the headlights when the high beam is selected, pull the lever twice towards the rear position.

When the lever is pulled towards the rearmost position ③ after the power switch is placed in the OFF position, the headlight will turn on and stay on for 30 seconds. The lever can be pulled 4 times for up to 2 minutes.

High beam assist (where fitted)

The high beam assist system will operate when the vehicle is driven at speeds of approximately 40 km/h (25 MPH) and above. If an oncoming vehicle or leading vehicle appears in front of your vehicle when the headlight high beam is on, the headlight will be switched to the low beam automatically.

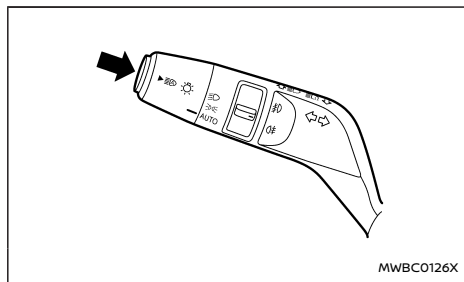
Precautions on high beam assist:

WARNING

- The high beam assist system is a convenience but it is not a substitute for safe driving operation. The driver should remain alert at all times, ensure safe driving practices and switch the high beams and low beam manually when necessary.
 - The high beam or low beam may not switch automatically under the following conditions. Switch the high beam and low beam manually.
 - During bad weather (rain, fog, snow, wind, etc.).
 - When a light source similar to a headlight or tail light is in the vicinity of the vehicle.
 - When the headlights of the oncoming vehicle or the leading vehicle are turned off, when the colour of the light is affected due to foreign materials on the lights, or when the light beam is out of position.
 - When there is a sudden, continuous change in brightness.
- When driving on a road that passes over rolling hills, or a road that has level differences.
 - When driving on a road with many curves.
 - When a sign or mirror-like surface is reflecting intense light towards the front of the vehicle.
 - When the container, etc. being towed by a leading vehicle is reflecting intense light.
 - When a headlight on your vehicle is damaged or dirty.
 - When the vehicle is leaning at an angle due to a punctured tyre, being towed, etc.
- The timing of switching the low beam and high beam may change under the following situations.
 - The brightness of the headlights of the oncoming vehicle or leading vehicle.
 - The movement and direction of the oncoming vehicle and the leading vehicle.
 - When only one light on the oncoming vehicle or the leading vehicle is illuminated.
 - When the oncoming vehicle or the leading vehicle is a two-wheeled vehicle.
 - Road conditions (incline, curve, the road surface, etc.).

- The number of passengers and the amount of cargo.

High beam assist operations:



Example

To activate the high beam assist system, push the switch as illustrated with the “AUTO” position. The high beam assist indicator light in the meter will illuminate while the headlights are turned on.

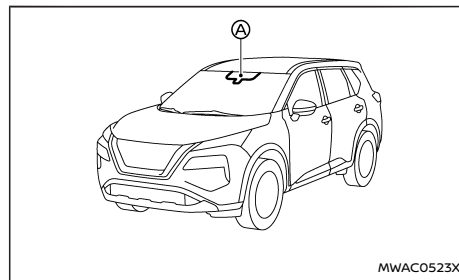
The high beam indicator light also illuminates when the high beam is selected by the high beam assist system.

If the high beam assist indicator light does not illuminate in the above condition, it may indicate that the system is not functioning properly. It is recommended you have the system checked by a NISSAN dealer or qualified workshop.

When the vehicle speed lowers to less than approximately 25 km/h (16 MPH), the headlight remains the low beam.

To turn off the high beam assist system, push the switch again.

Ambient image sensor maintenance:







The ambient image sensor (A) for the high beam assist system is located in front of the inside rearview mirror. To keep the proper operation of the high beam assist system and prevent a system malfunction, be sure to observe the following:

- Always keep the windscreen clean.
- Do not attach a sticker (including transparent material) or install an accessory near the ambient image sensor.
- Do not strike or damage the areas around the ambient image sensor. Do not touch the sensor lens that is located on the ambient image sensor.

If the ambient image sensor is damaged due to an accident, contact a NISSAN dealer or qualified workshop.

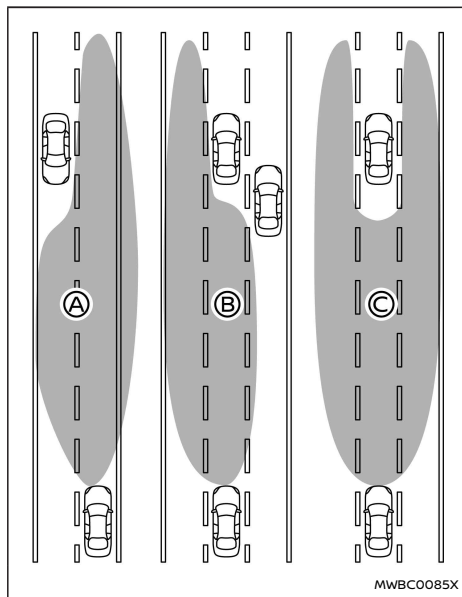
Battery saver system

- When the headlight switch is in the  or  position while the power switch is in the ON position, the lights will automatically turn off within a period of time after the power switch has been placed in the OFF position.
- When the e-POWER system is off, you can turn on the headlights, but the lights will automatically turn off after a period of time (where fitted).
- When the headlight switch remains in the  or  position after the lights automatically turn off, the lights will turn on:
 - When the power switch is placed in the ON position.
 - When the headlight switch is operated. (In this case, the lights will automatically turn off again after a period of time.)

CAUTION

- **When you turn on the headlight switch again after the lights automatically turn off, the lights will not turn off automatically. Be sure to turn the headlight switch to the “AUTO” position when you leave the vehicle for extended periods of time, otherwise the 12-volt battery will be discharged.**
- **Never leave the headlight switch on when the e-POWER system is not running for extended periods of time even if the headlights turn off automatically.**

Adaptive LED headlight (where fitted)



Example

The adaptive LED headlight system will operate when the vehicle is driven at speeds of approximately 40 km/h (25 MPH) and above. If an oncoming vehicle or leading vehicle appears in front of your vehicle when the headlight high beam is on, the system will change the area illuminated by the headlights automatically.

Example:

- Ⓐ Right side beam only (for an oncoming vehicle)
- Ⓑ Left side beam only (for leading vehicles)
- Ⓒ Split beam (for a leading vehicle)

Precautions on adaptive LED headlight:

⚠ WARNING

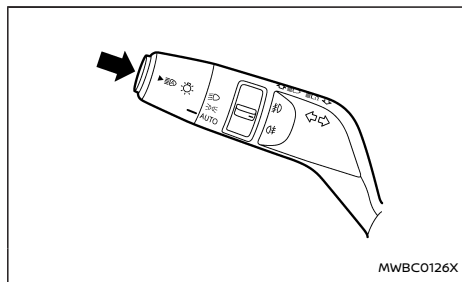
- The adaptive LED headlight system is a convenience but it is not a substitute for safe driving operation. The driver should remain alert at all times, ensure safe driving practices and switch the high beam and low beam manually when necessary.
- The high beam or low beam may not switch automatically under the following conditions. Switch the high beam and low beam manually.
 - During bad weather (rain, fog, snow, wind, etc.).
 - When a light source similar to a headlight or tail light is in the vicinity of the vehicle.
 - When the headlights of the oncoming vehicle or the leading vehicle are turned off, when the colour of the light is affected due to foreign materials on the lights, or when the light beam is out of position.
 - When there is a sudden, continuous change in brightness.
 - When driving on a road that passes

over rolling hills, or a road that has level differences.

- When driving on a road with many curves.
- When a sign or mirror-like surface is reflecting intense light towards the front of the vehicle.
- When the container, etc. being towed by a leading vehicle is reflecting intense light.
- When a headlight on your vehicle is damaged or dirty.
- When the vehicle is leaning at an angle due to a punctured tyre, being towed, etc.
- The timing of switching the low beam and high beam may change under the following situations.
 - The brightness of the headlights of the oncoming vehicle or leading vehicle.
 - The movement and direction of the oncoming vehicle and the leading vehicle.
 - When only one light on the oncoming vehicle or the leading vehicle is illuminated.
 - When the oncoming vehicle or the leading vehicle is a two-wheeled vehicle.
 - Road conditions (incline, curve, the road surface, etc.).

- The number of passengers and the amount of luggage.

Adaptive LED headlight operations:



Example

To activate the adaptive LED headlight system, push the switch as illustrated with the headlight switch in the "AUTO" position. The adaptive LED headlight indicator light in the meter will illuminate while the headlights are turned on.

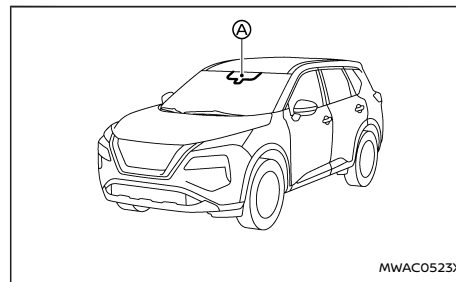
The high beam indicator light also illuminates when the high beam is on.

If the adaptive LED headlight indicator light does not illuminate in the above condition, it may indicate that the system is not functioning properly. Have the system checked by a NISSAN dealer or qualified workshop.

When the vehicle speed lowers to less than approximately 25 km/h (16 MPH), the headlight remains the low beam.

To turn off the adaptive LED headlight system, push the switch again.

Ambient image sensor maintenance:



The ambient image sensor **A** for the adaptive LED headlight system is located in front of the inside rearview mirror. To keep the proper operation of the adaptive LED headlight system and prevent a system malfunction, be sure to observe the following:

- Always keep the windscreen clean.
- Do not attach a sticker (including transparent material) or install an accessory near the ambient image sensor.
- Do not strike or damage the areas around the ambient image sensor. Do not touch the sensor lens that is located on the ambient image sensor.

If the ambient image sensor is damaged due to an accident, contact a NISSAN dealer or qualified workshop.

Daytime Running Light (DRL) system

Even if the headlights are off, the daytime running lights will come on after starting the e-POWER system.

When the headlight switch is turned to the **OFF** or **OFF** position, the daytime running light will turn off.

HEADLIGHT CLEANER (where fitted)

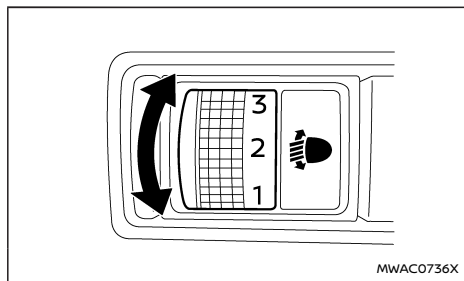
The headlight cleaner operates when the headlight is on and the power switch is in the ON position.

Pull the windscreen washer switch toward you. The headlight cleaner operates with the windscreen washer operation. This operation activates once each time the power switch is turned off and on.

CAUTION

Add the window washer fluid reservoir when the fluid is at a low level.

HEADLIGHT AIMING CONTROL



Select the switch position by referring to the following samples.

Manual type (where fitted)

The headlight aiming control operates when the power switch is in the ON position and the headlight is on to allow the headlight axis to be adjusted according to the driving condition.

When driving with no heavy load/luggage or driving on a flat road, select the normal position "0".

If the number of occupants and load/luggage in the vehicle changes, the headlight axis may become higher than normal.

If the vehicle is travelling on a hilly road, the headlights may directly shine on the rearview and outside rearview mirrors of a vehicle ahead or the windscreen of an oncoming vehicle, which may obscure other drivers' vision.

To adjust to the proper aiming height, turn the switch accordingly. The higher the number, designated on the switch, the lower the headlight axis.

Two row model:

Switch position	Number of front seat occupants	Number of rear seat occupants	Weight of load in the luggage compartment
0	1 or 2	No occupants	No load
1	2	3	No load
2	2	3	approx. 105 kg (232 lb)
3	1	No occupants	approx. 350 kg (772 lb)

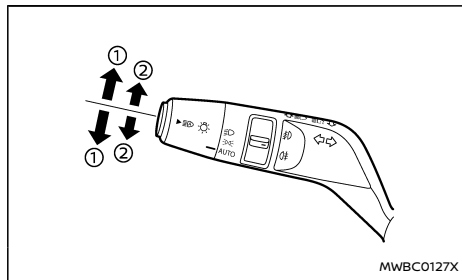
Three row model:

Switch position	Number of front seat occupants	Number of second row seat occupants	Number of third row seat occupants	Weight of load in the luggage compartment
0	1 or 2	No occupants	No occupants	No load
1	2	No occupants or 3	2	No load
2	2	3	2	approx. 95 kg (209 lb)
3	1	No occupants	No occupants	approx. 445 kg (981 lb)

Automatic type (where fitted)

The headlights are equipped with the automatic levelling system. Headlight axis is controlled automatically.

TURN SIGNAL SWITCH



Example

① Turn signal

Move the lever up or down to signal the turning direction. When the turn is completed, the turn signals cancel automatically.

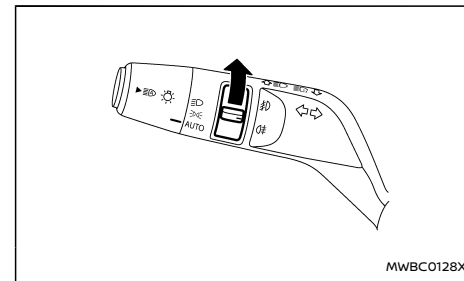
② Lane change signal

Move the lever up or down until the turn signal begins to flash, but the lever does not latch, to signal a lane change. Hold the lever until the lane change is completed.

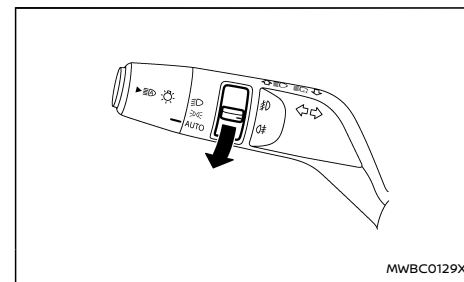
Move the lever up or down until the turn signal begins to flash, but the lever does not latch, and release the lever. The turn signal will automatically flash three times.

Choose the appropriate method to signal a lane change based on road and traffic conditions.

FOG LIGHT SWITCH



MWBC0128X



MWBC0129X

Example

FRONT FOG LIGHTS (where fitted)

To turn the fog lights on, turn the headlight switch to the D or D position, then turn the fog light switch to the D position.

To turn the fog lights on with the headlight switch in the "AUTO" position, the headlights or front clearance lights must be on, then turn the fog light switch to the D position. (Once the headlights,

WIPER AND WASHER SWITCH

front clearance lights and fog lights are turned on with the headlight switch in the "AUTO" position, they continue to illuminate even if the surroundings become bright.)

To turn them off, turn the fog light switch to the ☐ position again.

REAR FOG LIGHT

The rear fog light should be used only when visibility is seriously reduced (generally, to less than 100 m (328 ft)).

To turn the fog light on, turn the headlight switch to the ☐ position or turn the front fog lights (where fitted) on, then turn the fog light switch to the ☐ position.

To turn the fog light on with the headlight switch in the "AUTO" position, the headlights must be on, then turn the fog light switch to the ☐ position.

To turn off, turn the fog light switch to the ☐ position again.

WINDSCREEN WIPER AND WASHER OPERATION

⚠ WARNING

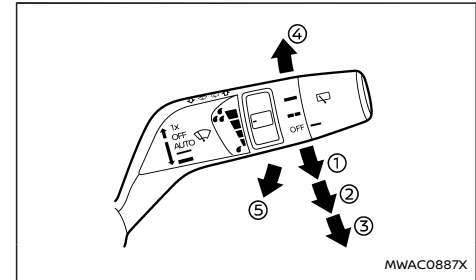
In freezing temperatures the washer solution may freeze on the windscreen and obscure your vision which may lead to an accident. Warm windscreen with the defogger before you wash the windscreen.

CAUTION

- **Do not operate the washer continuously for more than 30 seconds.**
- **Do not operate the washer if the reservoir tank is empty.**
- **Do not fill the window washer reservoir tank with washer fluid concentrates at full strength. Some methyl alcohol based washer fluid concentrates may permanently stain the grille if spilled while filling the window washer reservoir tank.**
- **Pre-mix washer fluid concentrates with water to the manufacturer's recommended levels before pouring the fluid into the window washer reservoir tank. Do not use the window washer reservoir tank to mix the washer fluid concentrate and water.**
- **Do not operate the windscreen wiper while the wiper arm is pulled up. The wiper arm may be damaged.**

If the windscreen wiper operation is interrupted by snow or ice, the wiper may stop moving to protect its motor. If this occurs, turn the wiper

switch to the OFF position and remove the snow or ice that is on and around the wiper arms. In approximately 1 minute, turn the switch on again to operate the wiper.



The windscreen wiper and washer operates when the power switch is in the ON position.

Push the lever down to operate the wiper at the following speed:

- ① AUTO — see "Rain-sensing auto wiper system" (P.130).
- ② Low — continuous low speed operation
- ③ High — continuous high speed operation

If the power switch is placed in the OFF position while the wiper operates in the high speed position, the wiper will not operate the next time the power switch is placed in the ON position. To operate the wiper, move the lever to any position other than high speed.

Push the lever up ④ to have one sweep operation of the wiper.

Pull the lever toward you ⑤ to operate the washer. Then the wiper will also operate several times.

The headlight cleaner (where fitted) will also operate with operation of the windscreen washer. (See "Headlight cleaner (where fitted)" (P.130).)

NOTE:

The Speed Dependent feature may be disabled. For additional information, refer to "Vehicle Settings" (P.97).

Headlight cleaner (where fitted)

Pull the lever toward the rear of the vehicle ⑤.

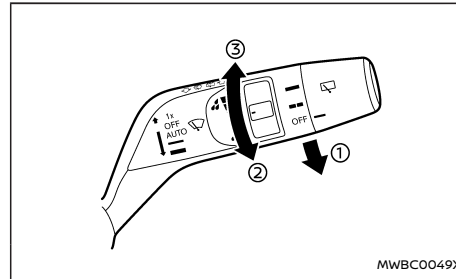
The headlight cleaner will operate with operation of the windscreen washer.

- The headlight cleaner operates with the windscreen washer operation. This operation activates once each time the power switch is turned off and on.
- After the first operation, the headlight cleaner operates once at every fifth operation of the windscreen washer.

CAUTION

Add the window washer fluid reservoir when the fluid is at a low level.

RAIN-SENSING AUTO WIPER SYSTEM



The rain-sensing auto wiper system can automatically turn on the wipers and adjust the wiper speed depending on the rainfall and the vehicle speed by using the rain sensor located on the upper part of the windscreen.

To set the rain-sensing auto wiper system, push the lever down to the "AUTO" position ①.

The rain sensor sensitivity level can be adjusted by turning the knob toward ② (Low) or ③ (High).

- High — High sensitive operation
- Low — Low sensitive operation

To turn the rain-sensing auto wiper system off, push up the lever to the "OFF" position, or pull down the lever to the other.

CAUTION

Do not touch the rain sensor and around it when the wiper switch is in the "AUTO" position and the power switch is in the ON position. The

wipers may operate unexpectedly and cause an injury or may damage a wiper.

- The rain-sensing auto wipers are intended for use during rain. If the switch is left in the "AUTO" position, the wipers may operate unexpectedly when dirt, fingerprints, oil film or insects are stuck on or around the sensor. The wipers may also operate when exhaust gas or moisture affect the rain sensor.
- When the windscreen glass is coated with water repellent, the speed of the rain-sensing auto wipers may be higher even though the amount of the rainfall is small.
- Be sure to turn off the rain-sensing auto wiper system when you use a car wash.
- The rain-sensing auto wipers may not operate if rain does not hit the rain sensor even if it is raining.
- Using genuine wiper blades is recommended for proper operation of the rain-sensing auto wiper system. (See "Windscreen wiper blades" (P.436) for wiper blade replacement.)

REAR WINDOW WIPER AND WASHER OPERATION

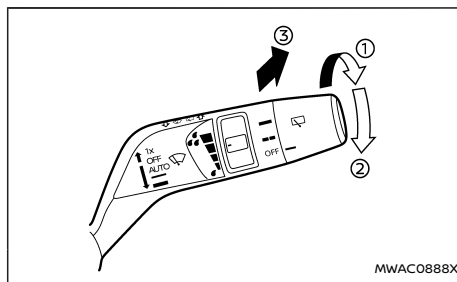
⚠ WARNING

In freezing temperatures the washer solution may freeze on the rear window glass and obscure your vision. Warm the rear window with the defogger before you wash the rear window.

CAUTION

- Do not operate the washer continuously for more than 30 seconds.
- Do not operate the washer if the reservoir tank is empty.
- Do not fill the window washer reservoir tank with washer fluid concentrates at full strength. Some methyl alcohol based washer fluid concentrates may permanently stain the grille if spilled while filling the window washer reservoir tank.
- Pre-mix washer fluid concentrates with water to the manufacturer's recommended levels before pouring the fluid into the window washer reservoir tank. Do not use the window washer reservoir tank to mix the washer fluid concentrate and water.

If the rear window wiper operation is interrupted by snow or ice, the wiper may stop moving to protect its motor. If this occurs, turn the wiper switch to the OFF position and remove the snow or ice that is on and around the wiper arms. In approximately 1 minute, turn the switch on again to operate the wiper.



The rear window wiper and washer operate when the power switch is in the ON position.

Turn the switch clockwise from the OFF position to operate the wiper.

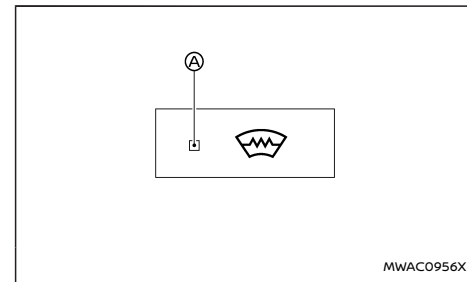
- ① Intermittent (INT) – intermittent operation (not adjustable)
- ② Low (ON) – continuous low speed operation
Push the switch forward ③ to operate the washer. Then the wiper will also operate several times.

Reverse Link feature:

When the windscreen wiper switch is on, moving the shift lever to the R (Reverse) position will operate the rear window wiper.

NOTE:

The Reverse Link feature may be disabled. For additional information, refer to "Vehicle Settings" (P.97).

HEATED WINDSCREEN (where fitted)

The heated windscreen button is located on the front air conditioner control panel.

To defog/defrost the windscreen, start the e-POWER system and push the heated windscreen button. The indicator light Ⓐ will illuminate.

Push the button again to turn the system off.

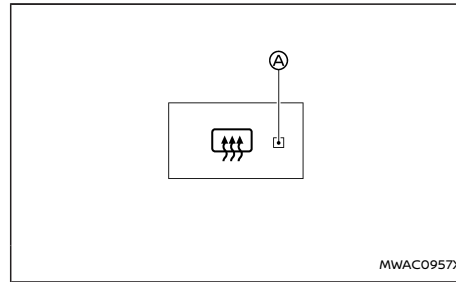
The system will turn off automatically after a period of time. If the windscreen clears before this time, push the button again to turn the system off.

NOTE:

- The system can only be activated while the e-POWER system is running.
- Before activating the system make sure to remove excess snow/ice from the windscreen.
- Electrical conductors embedded in the windscreen provide the heating of the windscreen. If damage occurs to the windscreen have the system checked by a NISSAN dealer or qualified workshop.

DEFOGGER SWITCH

- Reduced performance or deactivation of the heated windshield may be noticed to preserve the 12-volt battery. This is not a malfunction.
- NISSAN recommends using the system to support defogging of the windshield.



Example

The defogger switch is located on the front air conditioner control panel.

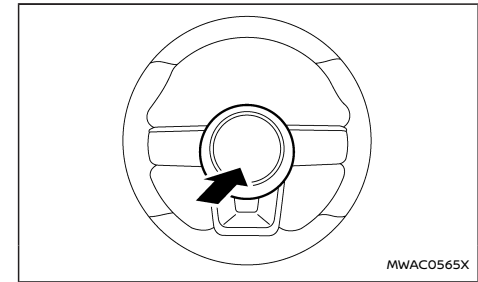
To defog/defrost the rear window glass and outside rearview mirrors, start the e-POWER system and push the switch on. The indicator light (A) will illuminate. Push the switch again to turn the defogger off.


It will automatically turn off in approximately 20 minutes.

CAUTION

- When operating the defogger continuously, be sure to start the e-POWER system. Otherwise, it may cause the 12-volt battery to discharge.
- When cleaning the inner side of the window, be careful not to scratch or damage the electrical conductors on the surface of the window.

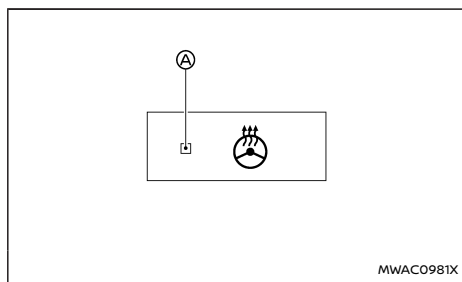
HORN



The horn switch  operates regardless of the power switch position except when the 12-volt battery is discharged.


When the horn switch is pushed and held, the horn will sound. Releasing the horn switch will cease the horn sound.

HEATED STEERING WHEEL SWITCH (where fitted)



Example

The heated steering wheel switch is located on the front air conditioner control panel.

Push the heated steering wheel switch to warm the steering wheel after the power switch is placed in the ON position. The indicator light  will illuminate. Push the switch again to turn the system off.

If the surface temperature of the steering wheel is below 20°C (68°F), the system will heat the steering wheel and cycle off and on to maintain a temperature above 20°C (68°F). The indicator light will remain on as long as the system is on (approximately 30 minutes).

Push the switch again to turn the heated steering wheel system off manually.

NOTE:

Once activated, your heated steering wheel will automatically turn on and off to maintain a temperature above 20°C (68°F).

When the temperature of the steering wheel is

above 50°C (122°F) and the heated steering wheel switch is turned on, the system will not heat the steering wheel. This is not a malfunction.

REAR DOOR ALERT (Where fitted)

The Rear Door Alert system functions under certain conditions to indicate there may be an object or passenger in the rear seat(s). Check the seat(s) before exiting the vehicle.

The Rear Door Alert system is initially disabled. The driver can enable the system using the vehicle information display. (See "Vehicle Settings" (P.97).)

When the system is enabled:

- The system is activated when a rear door is opened and closed. When the vehicle is started and the system is activated, a visual message appears in the vehicle information display. (See "25. [Rear Door Alert is Activated] indicator (where fitted)" (P.106).)
- If a rear door is opened and closed but the vehicle is not driven, the system will not be activated. A rear door must be opened and closed and the car driven for the system to activate.
- The time interval to activate the system between when the rear door is opened and closed and the vehicle is started is about 10 minutes. A longer interval does not indicate a malfunction.

When the Rear Door Alert system is activated:

- When the driver puts the vehicle in the P (Park) position, a notification message appears in the vehicle information display with the options to [Dismiss Message] or [Disable Alert] if desired.
 - Select [Disable Alert] to temporarily disable for that stop.
 - No selection or [Dismiss Message] will keep the alert enabled for that stop.

- If the alert is enabled when a driver exits the vehicle, a message will appear in the vehicle information display that states [Reminder Check Rear Seat.]

If [Horn & Alert] setting is selected:

- An audible horn sound will occur after a short time unless a rear door is opened and closed within a short time to deactivate the alert.
- If the doors are locked before the alert is deactivated by opening a rear door, the horn will sound.
- If the back door is opened before a rear door is opened, the horn will be delayed until after the back door is closed.

NOTE:

If [Alert Only] setting is selected, the message alert will still be shown in the vehicle information display but the horn will not sound.

⚠ WARNING

- If the driver selects [Disable Alert], no audible alert or a message will be provided regardless of rear door open/close status.
- There may be times when there is an object or passenger in the rear seat(s) but the audible alert does not sound. For example, this may occur if rear seat passengers enter or exit the vehicle during a trip.
- The system does not directly detect objects or passengers in the rear seat(s). Instead, it can detect when a rear door is

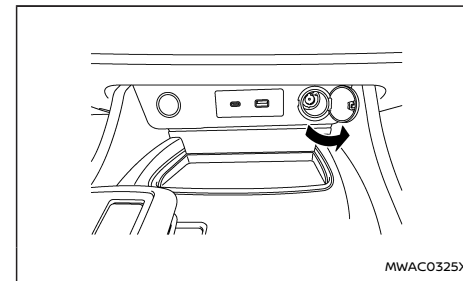
opened and closed, indicating that there may be something in the rear seat(s).

NOTE:

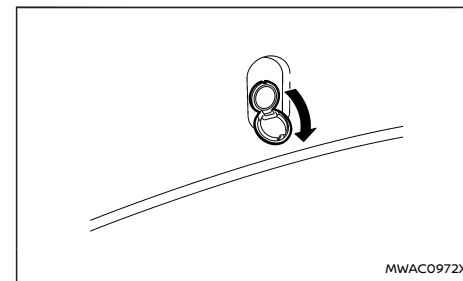
There may be times when the horn sounds but there are no objects or passengers in the rear seat(s).

(See "25. [Rear Door Alert is Activated] indicator (where fitted)" (P.106).)

POWER OUTLETS



Instrument panel (example)



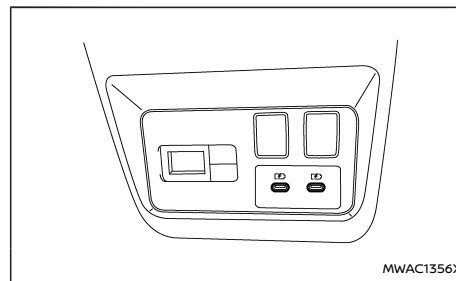
Luggage area (example)

The power outlets is located in the lower part of the instrument panel* and in the luggage area.

*: The layout in the illustration is for the Left-Hand Drive (LHD) model. For the Right-Hand Drive (RHD) model, the outlet is located on the opposite side.

CAUTION

- The outlet and plug may be hot during or immediately after use.
- Do not use with accessories that exceed a 12 volt, 120W (10A) power draw. Do not use double adapters or more than one electrical accessory.
- Use power outlet with the e-POWER system running to avoid discharging the vehicle 12-volt battery.
- Avoid using power outlet when the air conditioner, headlights or rear window defogger is on.
- This power outlet is not designed for use with a cigarette lighter unit.
- Push the plug in as far as it will go. If good contact is not made, the plug may over-heat.
- Before inserting or disconnecting a plug, be sure the electrical accessory being used is turned OFF.
- When not in use, be sure to close the cap. Do not allow water or any liquid to contact the outlet.

USB (Universal Serial Bus) CHARGING CONNECTOR (where fitted)**Example**

The USB charging connector is located on the back of the centre console box.

The USB charging connector can be used only for charging an external device.

Connect a USB device into the connector. Charging will start automatically. For USB charging connector, maximum output is up to 5 volt, 15W, 3A (for USB Type-C).

The external device will be charged continuously while the power switch is in the ON position.

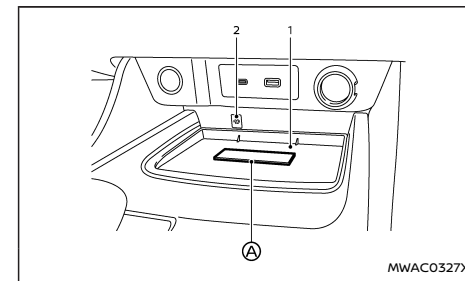
Some mobile devices cannot be charged depending on their specifications.

CAUTION

- Do not force a USB device into the connector. Depending on the USB connector, inserting the USB device tilted or upside down may damage the connector. Make

sure that the USB device is connected correctly into the connector.

- Do not use a reversible USB cable. Using the reversible USB cable may damage the connector.

WIRELESS CHARGER**Example**

1. Charging pad
2. Indicator

The wireless charger is located on the front of the centre console. Lay the smartphone on the pad of the wireless charger. Charging will start automatically. The smartphone will be charged continuously while the power switch is in the ON position.

⚠ WARNING

- Never put metallic materials between the wireless charger and a smartphone.
- Those who use a pacemaker or other medical equipment should contact the

electric medical equipment manufacturer for the possible influences before use.

- Never put cloth over the smartphone during charging process.
- Never charge a smartphone when it is wet.
- Never put metallic materials or small goods such as a cigarette lighter, Intelligent Key or memory drive.

CAUTION

- Do not put an RFID/NFC/credit card between the wireless charger and a smartphone. This could cause data corruption in the card.
- Do not use the wireless charger with dust accumulated or dirt on the pad.
- Do not hit the surface of the wireless charger.
- Do not spill liquid (water, drinks, etc.) on the charging pad.
- Do not use grease, oil or alcohol for cleaning charging pad.

Wireless charger Indicator

The indicator (🔌) will illuminate in orange when the charging process is started.

When the charging has completed, the indicator illuminates in green.

If a malfunction occurs or the charging process has stopped, the indicator will blink in orange for 8 seconds then turn off.

Operation of the wireless charger

To use the wireless charger, it is necessary to seat the smartphone well within the charging pad. To maximise charging performance, ensure the smartphone is fully seated on the centre of the charging pad over the “Qi” logo (📶). Because the location of the power receiver may vary depending on the smartphone, you will need to try and find the area that suits your smartphone.

Because some smartphone cases or accessories may adversely affect charging, remove them before wireless charging.

Turn off the vibration function of the smartphone before wireless charging.

NOTE:

- Only a Qi compatible smartphone can be used.
- The smartphone or the wireless charger may be warmed during charging process and the charging may stop by the protection function of the smartphone or the wireless charger. This is not a malfunction. If this occurs, restart charging after the smartphone or the wireless charger cooled down. The indicator will blink in orange then turn off.
- The wireless charging process may be stopped by the status of the smartphone (battery temperature, etc.).
- If a radio noise interference occurs during charging process, put the smartphone onto the centre (“Qi” logo) position of the wireless charger.

- The wireless charging process will stop during process of searching the Intelligent Key.
- The wireless charging process will not be started when a USB (Universal Serial Bus) cable is connected to the smartphone. The indicator may illuminate in orange or blink if the smartphone is put on the wireless charger with a USB cable connected. However, charging is not performed.
- Depending on the type of the smartphone, the indicator may remain illuminated in orange even when the charging process has been completed.

EMERGENCY SERVICES CALL ECALL/SOS SYSTEM (where fitted)

Your vehicle is equipped with the 112-based in-vehicle emergency services call system (eCall). In the event of a serious road accident emergency an automatic call can be made to the emergency services operator. The system can also be used manually to call the emergency services operator.

The 112-based eCall service is a public service of general interest and is accessible free of charge.

NISSAN is responsible only for the emergency communication system technical performance in the event of an accident within the warranty period.

AUTOMATIC ECALL

If the air bag control unit detects a frontal collision, side collision or rear collision (where fitted) the system automatically places an emergency call to the emergency call centre. At the same time, the vehicle information is also transferred. Once an emergency call is received by the emergency call centre, the operator tries to talk to the vehicle's occupant.

NOTE:

- **During the emergency call, the volume of the voice of the operator cannot be adjusted.**
- **During the emergency call, the volume of the vehicle audio will be muted.**

The eCall system is always enabled by default. It is activated automatically by means of in-vehicle sensors in the event of a severe accident.

The eCall system is not traceable and is not subject to any constant tracking in its normal operational status. Data in the internal memory of the system

is not available outside the in-vehicle system to any entities before the eCall is triggered.

Any processing of personal data through the 112-based eCall in-vehicle system shall comply with the personal data protection rules provided for in Directives 95/46/EC and 2002/58/EC of the European Parliament and of the Council, and in particular, shall be based on the necessity to protect the vital interests of the individuals in accordance with Article 7(d) of Directive 95/46/EC.

Processing of such data is strictly limited to the purpose of handling the emergency eCall to the single European emergency number 112.

Recipients of data processed by the 112-based eCall in-vehicle system are the relevant public safety answering points designated by the respective public authorities of the country on which territory they are located, to first receive and handle eCalls to the single European emergency number 112.

The following information will be sent to the emergency call centre by the vehicle emergency call system if a collision occurs:

- Vehicle Identification Number (VIN)
- Vehicle type
- Activation type (Automatic/Manual)
- Call type (Test/Emergency)
- Position (Trusted/Low confidence)
- Time stamp (when the collision or event occurred)
- Last three vehicle locations, and vehicle direction

- Vehicle speed
- Number of passengers (where fitted)

The 112-based eCall in-vehicle system is designed in such a way as to ensure that data in the system internal memory is automatically and continuously removed.

The vehicle location data is constantly overwritten in the internal memory of the system so as always to keep maximum of the last three up-to-date locations of the vehicle necessary for the normal functioning of the system.

The log of activity data in the 112-based eCall in-vehicle system is kept for no longer than necessary for attaining the purpose of handling the emergency eCall and in any case not beyond 13 hours from the moment an emergency eCall was initiated.

CAUTION

- **The intelligent emergency call will only be triggered if the vehicle air bag system is activated during the collision.**
- **If the intelligent emergency call has been triggered, please bring your vehicle to a NISSAN dealer or qualified workshop or qualified workshop. This is necessary because the intelligent emergency call system needs to be reset to avoid any unintended eCall being made.**
- **The mobile network provider that manages the connection from the vehicle to the emergency call centre is specified and controlled outside of the vehicle emergency call system.**

- Within the first minute of any emergency call the operator will determine if the call is genuine. Should the operator determine it is a non-genuine call they will stop the call, making no further attempts to call the vehicle back. This action does not prevent the occupant(s) of the vehicle from making a further manual emergency call.

The emergency call function cannot be used in the following conditions:

- The vehicle is outside the area where mobile network service is receivable.
- The vehicle is in a location with poor signal reception such as tunnels, underground parking garages, between buildings or in mountainous areas.
- The TCU (Telematics Control Unit) or other systems of your vehicle are not working properly.
- The available mobile network provider at the location of the vehicle is not specified for emergency call usage.
- The communication line of the emergency call centre is busy.

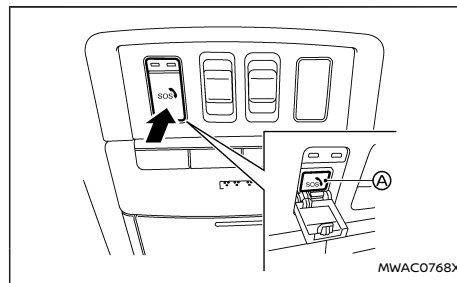
MANUAL ECALL (SOS button)

The manual eCall can be performed with the power switch placed in the ON position, by pushing the SOS call button located near the map lights.

After the power switch is placed in the OFF position, if an emergency call was not made, the eCall system is turned off.

CAUTION

- Park the vehicle in a safe location and apply the parking brake before operating the SOS button.
- Use this service only in case of an emergency. There may be a penalty for inappropriate use of the service.



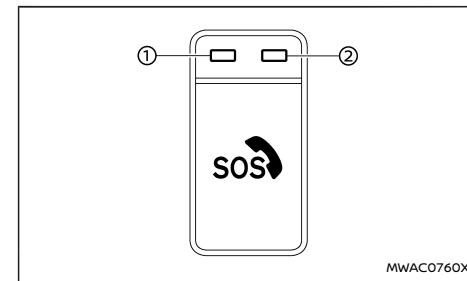
1. Place the power switch in the ON position.
2. Push to open the SOS cover.
3. Push the SOS button (A). An emergency call is sent to the emergency call centre. At the same time, the vehicle information is also transferred.
4. When the call is connected, you can speak to the emergency support staff.

If you want to cancel the emergency call, push and hold the SOS button for a few seconds. The call cannot be cancelled after connection.

NOTE:

- During the emergency call, the volume of the voice of the operator cannot be adjusted.
- During the emergency call, the volume of the vehicle audio will be muted.
- After the SOS button is pushed, it may take some time until the system initiates connection, depending on the technical environment and whether the TCU is being used by other services.
- To avoid disconnecting the call, do not turn the e-POWER system off.
- During the emergency call Bluetooth® Hands-Free Phone connection will be disabled and phone operation will only be available by mobile phone.
- If the emergency call is disconnected for some reason the emergency call centre may call back. This action does not prevent the occupant(s) of the vehicle from making another manual emergency call.

SYSTEM STATUS INDICATOR



The indicator lights ① and ② above the SOS button indicate the status of the vehicle emergency call system. If the indicator light is illuminated red or no indicator light is illuminated the emergency call may not connect to the emergency call centre when the SOS button is pressed. Also an intelligent Emergency call may not be sent when a collision occurs.

- During vehicle start up the system operates self diagnostics and the red indicator light is illuminated for up to 15 seconds.
- At any other time if the red indicator light is illuminated contact a NISSAN dealer or qualified workshop or qualified workshop for assistance. In the event of a critical system failure that would disable the 112-based eCall in-vehicle system, the red indicator light is illuminated as a warning.

NOTE:

If the indicator light is illuminated red or no indicator light is illuminated, emergency services (such as the police or other agencies) should be contacted using other normal communication devices (for example a phone) in the event of an accident.

MODALITIES FOR EXERCISING DATA SUBJECT'S RIGHTS

The data subject (the vehicle's owner) has a right of access to data and as appropriate to request the rectification, erasure or blocking of data, concerning him or her, the processing of which does not comply with the provisions of Directive 95/46/EC. Any third parties to whom the data have been disclosed have to be notified of such

rectification, erasure or blocking carried out in compliance with this Directive, unless it proves impossible or involves a disproportionate effort.

The data subject has a right to complain to the competent data protection authority if he or she considers that his or her rights have been infringed as a result of the processing of his or her personal data.

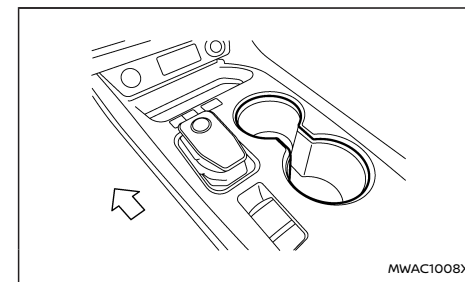
STORAGE

CUP HOLDERS

CAUTION

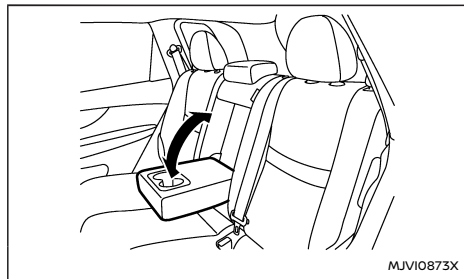
- **Avoid abrupt starting and braking when the cup holder is being used to prevent spilling the drink. If the liquid is hot, it can scald you or your passenger.**
- **Use only soft cups in the cup holder. Hard objects can injure you in an accident.**

Front

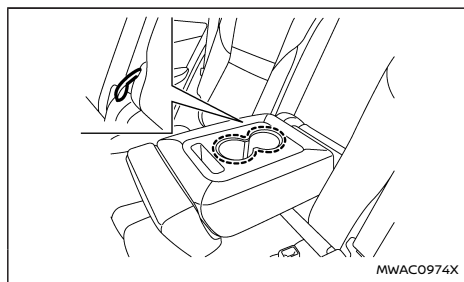


Centre console

Second row seat



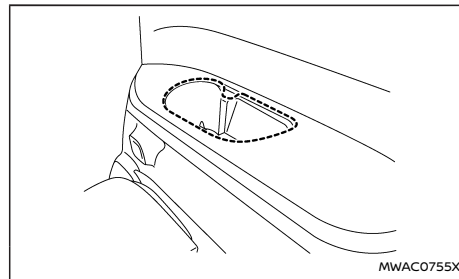
Two row model



Three row model

The cup holders are located in the fold-down armrest.

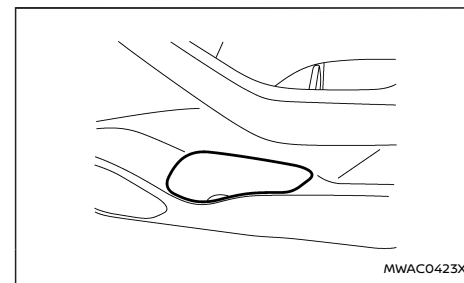
Third row seat (where fitted)



SOFT BOTTLE HOLDERS

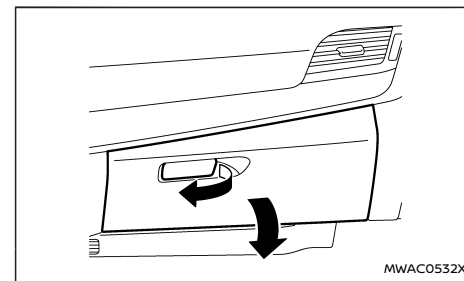
CAUTION

- Do not use bottle holder for any other objects that could be thrown about in the vehicle and possibly injure people during sudden braking or an accident.
- Do not use bottle holder for open liquid containers.



Door (front and second row seats)

GLOVE BOX



⚠ WARNING

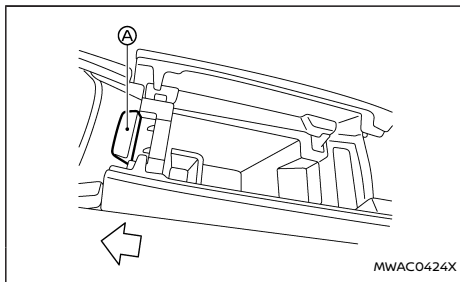
Keep glove box lid closed while driving to help prevent injury in an accident or a sudden stop.

To open the glove box, pull the handle.

To close, push the lid in until the lock latches.

The glove box light illuminates when the headlight switch is turned on.

CONSOLE BOX

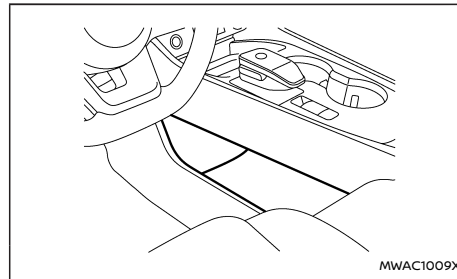


To open the console box lids, push the knob **A** in the rearward.

To close, push each lid down until the lock latches.

If something is put on top of either side of the lids, that side lid may not open. Remove any object and push the knob again to open the lid.

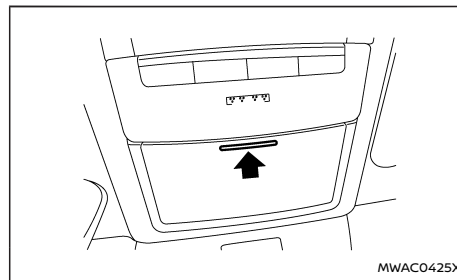
LOWER CONSOLE TRAY



CAUTION

Do not place any objects in lower console tray that could be thrown about in the vehicle and cause injury during sudden braking or collision.

SUNGLASSES HOLDER



WARNING

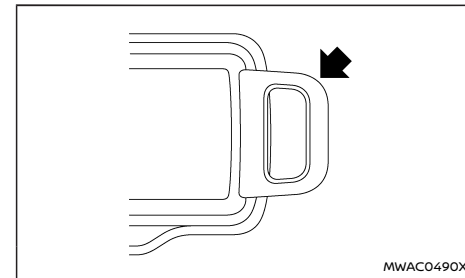
Keep the sunglasses holder closed while driving to avoid obstructing the driver's view and to help prevent an accident.

CAUTION

- Do not use for anything other than sunglasses.
- Do not leave sunglasses in the sunglasses holder while parking in direct sunlight. The heat may damage the sunglasses.

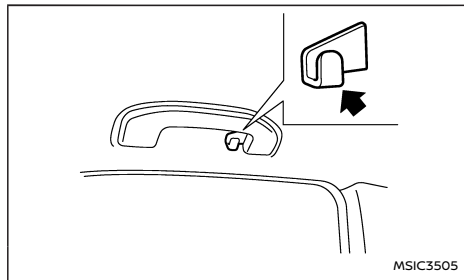
To open the sunglasses holder, push and release. Only store one pair of sunglasses in the holder.

CARD HOLDER



Slide a card in the card holder.

COAT HOOKS

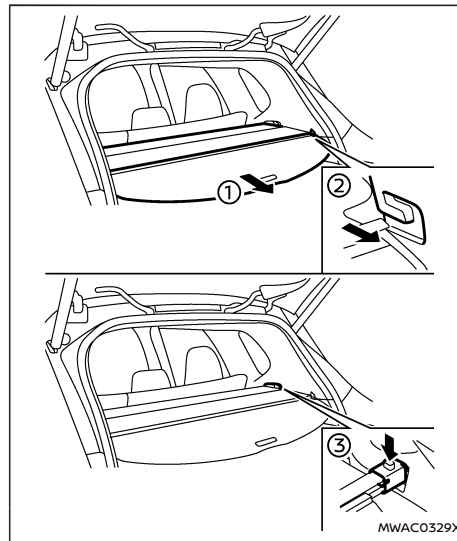


The coat hooks are located above the rear side windows.

CAUTION

Do not apply a total load of more than 1 kg (2 lb) to the hook.

TONNEAU COVER



The tonneau cover keeps the luggage compartment contents hidden from the outside.

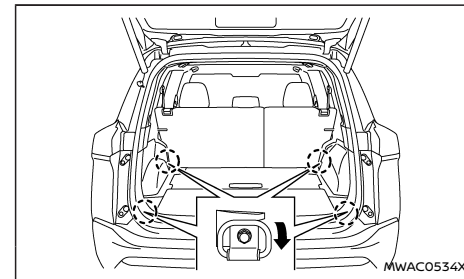
To use the tonneau cover, pull it out ① and insert both sides to the guide ②.

To remove the tonneau cover, stow the cover and push the button ③.

⚠ WARNING

- Never put anything on the tonneau cover, no matter how small. Any object on it could cause an injury in an accident or sudden stop.
- Do not leave the tonneau cover in the vehicle with it disengaged from the holder.
- The child restraint top tether strap may be damaged by contact with the tonneau cover or items in the luggage area. Remove the tonneau cover from the vehicle or secure it in the luggage area. Also secure any items in the luggage area. Your child could be seriously injured or killed in a collision if the top tether strap is damaged.

LUGGAGE HOOKS



To use the hook, pull it down as illustrated.

⚠ WARNING

- Always make sure that the cargo is properly secured. Use the suitable ropes and hooks.
- Unsecured cargo can become dangerous in an accident or sudden stop.
- Do not apply a total load of more than 3 kg (7 lb) to a single hook.

ADJUSTABLE LUGGAGE FLOOR (where fitted)

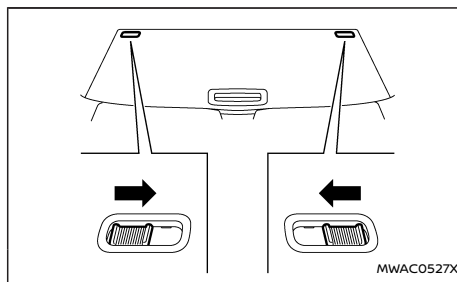
You can use the luggage compartment in different ways using the adjustable luggage boards.

⚠ WARNING

Do not put objects heavier than 75 kg (165 lbs) on the load floor while in the upper position.

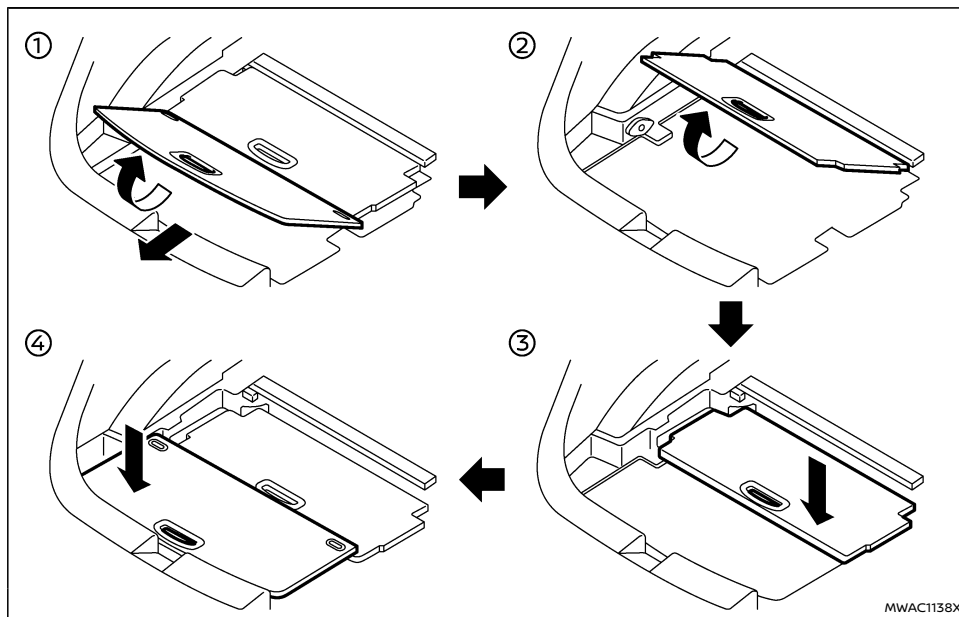
CAUTION

- Do not push the front edge of the luggage board forcibly. Doing so may cause the luggage board to be tilted, resulting in personal injury.
- Do not handle the luggage board forcibly as this may deform it.
- While in the upper position, do not recline the seatbacks.
- Do not place cargo higher than the seatbacks. In a sudden stop or collision, unsecured cargo could cause personal injury.



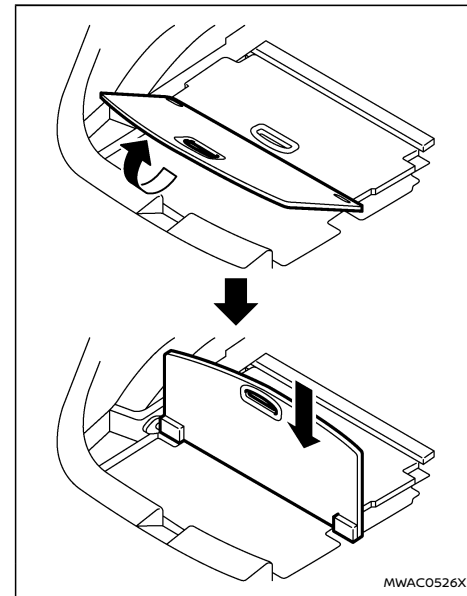
Before moving the rear (outer) luggage board, release the lock on the both sides of the board as shown (where fitted).

Two-stage mode



1. Remove the rear board from the luggage compartment ①.
2. Pull the front board upward to approximately 30° and then toward the rear of the vehicle ②.
3. Push the front board into the bottom of the luggage under space ③.
4. Replace the rear board ④.

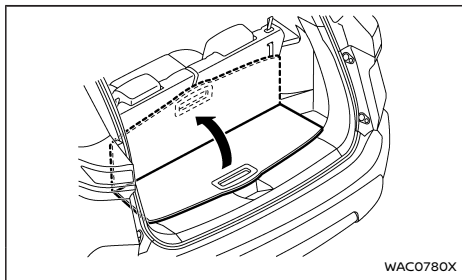
Vertical mode



1. Pull the rear board upward to 90°.
2. Push down the board until it stops.

LUGGAGE BOARD

Vertical mode (Three row model)

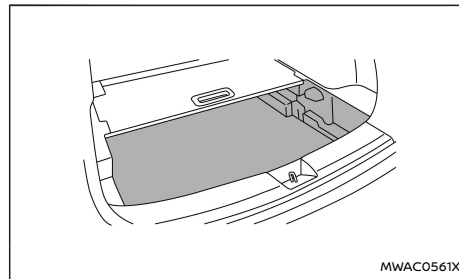


To use the vertical mode, insert the luggage board to slit of the finisher.

CAUTION

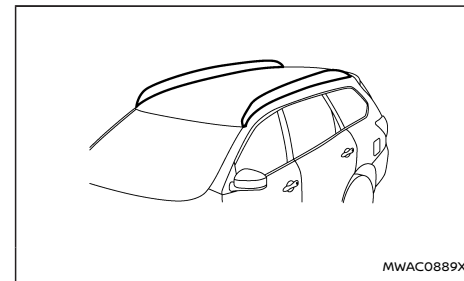
Do not place the luggage board at vertical position while driving. This could damage the luggage board. Place the luggage board at normal position while driving.

LUGGAGE UNDER SPACE (where fitted)



To use the luggage under space, pull off the rear board.

ROOF RACK (where fitted)



Do not apply any load directly to the roof side rails. Cross bars must be installed before applying load/cargo/luggage to the roof of the vehicle. For additional information, it is recommended that you contact a NISSAN dealer or qualified workshop.

The service load capacity for the roof side rails is 100 kg (221 lb), however do not exceed the accessory cross bars load capacity.

WARNING

- Always install the cross bars onto the roof side rails before loading cargo of any kind. Loading cargo directly onto the roof side rails or the vehicle's roof may cause vehicle damage.
- Drive extra carefully when the vehicle is loaded at or near the cargo carrying capacity, especially if the significant portion of that load is carried on the cross bars.
- Heavy loading of the cross bars has the

WINDOWS

potential to affect the vehicle stability and handling during sudden or unusual handling manoeuvres.

- Roof rack cross bars should be evenly distributed.
- Do not exceed maximum roof rack cross bars load.
- Properly secure all cargo with ropes or straps to help prevent it from sliding or shifting. In a sudden stop or collision, unsecured cargo could cause personal injury.

CAUTION

Use care when placing or removing items from the roof rack. If you cannot comfortably lift the items onto the roof rack from the ground, use a ladder or a stool.

POWER WINDOWS

⚠ WARNING

The driver is always responsible for all the power window operation including passenger's operation. Be sure to observe the following warnings for safety.

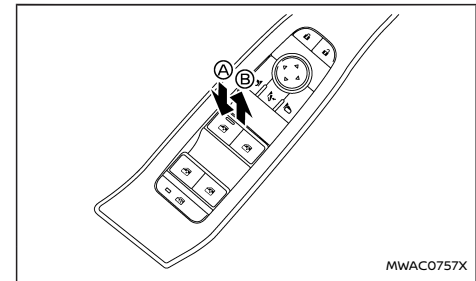
- Never allow anyone to extend any portion of their body or objects out of the opening while the vehicle is in motion. Otherwise they may be seriously damaged by coming into contact with objects outside the vehicle or when abruptly braking.
- Make sure that all passengers have their hands, etc. inside the vehicle before operating the windows. Do not intentionally activate the auto-reverse function. If their hands or faces are caught in the windows, it could cause serious injury.
- Never allow children to operate the power window. Improper operation by children could lead to an accident. Depress the window lock button since children or other persons could be caught in the power window and this may cause serious damage.
- When operating the power windows, let children know it and make sure that their hands, arms, etc. are not placed near the power windows. Otherwise they may be caught in the power windows.
- Make sure that the power switch is in the OFF position and do not leave the Intelligent Key and children unattended inside

the vehicle. They could unknowingly activate switches or controls. Unattended children could become involved in serious accidents.

- To help avoid risk of injury or death through unintended operation of the vehicle and or its systems, including entrapment in windows or inadvertent door lock activation, do not leave children, people who require the assistance of others or pets unattended in your vehicle. Additionally, the temperature inside a closed vehicle on a warm day can quickly become high enough to cause a significant risk of injury or death to people and pets.

The power windows operate when the power switch is in the ON position.

Driver's window switch



MWAC0757X

Example

The driver's switch, the main switch, can control all windows.

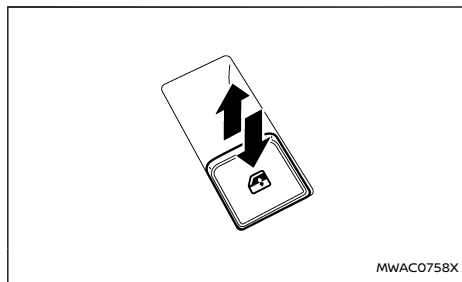
To open a window, push down ① the power window switch.

To close a window, pull up ② the power window switch.

Locking passengers' windows:

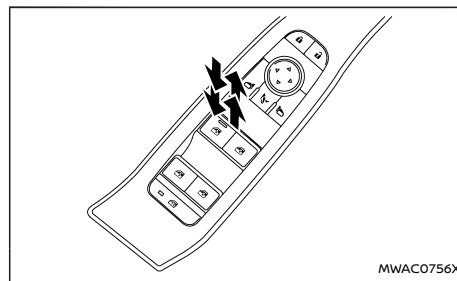
When the window lock button is pushed (the indicator illuminates), the rear passenger's windows cannot be operated with the rear passenger's power window switch. The rear passenger's windows can only be operated with the main switch (driver side switches). To cancel the passenger's windows lock, push the window lock button again.

Passenger side power window switch



The passenger's switch can control its corresponding window. When the window lock button on the driver's switch is pushed, the rear passenger's switch cannot be operated.

Automatic function



Example

The automatic function enables a window to fully open or close without holding the switch down or up.

To fully open the window, push the power window switch down to the second detent and release the switch. To fully close the window, pull the power window switch up to the second detent and release the switch. The switch does not have to be held during window operation.

To stop the window open/close operation during the automatic function, push down or pull up the switch in opposite directions.

Auto-reverse function:

⚠ WARNING

There is a small distance just before the closed position which cannot be detected. Make sure that all passengers have their hands, etc. inside the vehicle before closing the windows.

The auto-reverse function enables a window to automatically reverse when something is caught in the window as it is closing by the automatic function. When the control unit detects an obstacle, the window will be lowered immediately.

Depending on the environment or driving conditions, the auto-reverse function may activate if an impact or load similar to something being caught in the window occurs.


Window timer:



The window timer allows the window switch to be operated for a short time even if the power switch is placed in the OFF position. The window timer will be cancelled when the driver's or front passenger's side door is opened or the preset time has expired.

Operating windows with Intelligent Key


The windows can be opened or closed by pushing the UNLOCK or LOCK button on the Intelligent Key. This function will not operate while the window timer is activated or when the windows need to be initialised. For details about the Intelligent Key button usage, see "How to use remote keyless entry function" (P.168).


Opening:


To open the windows, push the UNLOCK  button on the Intelligent Key for about 3 seconds after the door is unlocked.

To stop opening, release the UNLOCK  button. If the window open operation is stopped on the way while pushing the UNLOCK  button, release and push the button again until the windows open completely.

Closing:

To close the windows, push the LOCK  button on the Intelligent Key for about 3 seconds after the door is locked.

To stop closing, release the LOCK  button.

If the window close operation is stopped on the way while pushing the LOCK  button, release and push the button again until the windows close completely.

When power window switch does not operate

If the power window automatic function does not operate properly, perform the following procedure to initialise the power window functions.

1. Close the door.
2. Place the power switch in the ON position.
3. Pull the power window switch and hold it to fully close the window.*1
4. Release the power window switch.
5. Pull the power window switch and hold it for approximately 5 seconds or more.*2
6. Push the power window switch down and hold it to fully open the window.
7. Release the power window switch.
8. Push the power window switch down and hold it for approximately 5 seconds or more.*2
9. Pull the power window switch and hold it to fully close the window.*1
10. Operate the window by the automatic function (window open and close) to confirm that the initialisation is complete.

*1: If the window stops before reaching the fully closed position, release the switch, then pull and hold it again to fully close the window.

*2: After pulling or pushing the power window switch and holding it for approximately 5 seconds or more, the window will move again.

If the window cannot automatically be closed since the auto-reverse function activated due to a malfunction, perform the following procedure to cancel the auto-reverse function.

1. Pull the power window switch up until the auto-reverse function is activated, then the window will reverse automatically.
2. Repeat the procedure twice.
3. Pull the power window switch and hold it to close the window to confirm that the cancellation is completed.

⚠ WARNING

When the auto-reverse function is cancelled, the window will not automatically reverse even if the control unit detects an obstacle. Make sure that all passengers have their hands, etc. inside the vehicle before closing the windows.

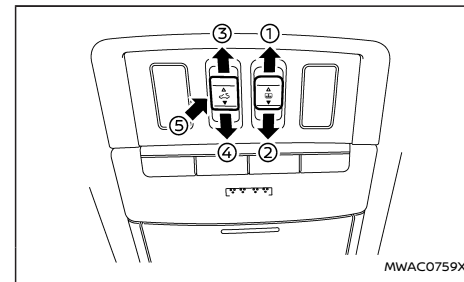
If the power window functions do not operate properly after performing the procedure above, have your vehicle checked by a NISSAN dealer or qualified workshop.

SUNROOF (where fitted)**⚠ WARNING**

- In an accident you could be thrown from the vehicle through an open sunroof. Always use seat belts and child restraints.
- Do not allow anyone to stand up or extend any portion of their body out of the sunroof opening while the vehicle is in motion or while the sunroof is closing.

CAUTION

- Remove water drops, snow, ice or sand from the sunroof before opening.
- Do not place any heavy object on the sunroof or surrounding area.

AUTOMATIC SUNROOF AND SUNSHADE

Sliding sunshade and sunroof

When the sunshade switch is pushed to the OPEN position ①, the sunshade will open. (If the sunshade starts to open from the position between close and half open, the sunshade will stop half. When the switch is pushed again, the sunshade will open fully.) When the sunroof switch is pushed to the OPEN position ③, the sunroof opens to the comfort mode position. (If the sunshade is close, the sunshade will open half first. When the switch is pushed again, the sunroof will open fully.)

When the sunroof switch is pushed to the CLOSE position ④, the sunroof will automatically close. When the sunshade switch is pushed to the CLOSE position ②, the sunshade will close. (If the sunshade starts to close from the position between full and half open, the sunshade will stop half. When the switch is pushed again, the sunshade will close fully. However, if the sunroof is open or tilted up, the sunshade will not close beyond half.)

To stop the sunshade or sunroof during the operation, push the sunroof switch to either of the OPEN ①, ③, CLOSE ②, ④ or UP ⑤ position.

Tilting sunroof

To tilt up the sunroof, push the sunroof switch to the up position ⑤.

To tilt down the sunroof, push the switch to the CLOSE position ④.

Comfort mode

This is the position used when driving with the sunroof open. When driving with the sunroof fully open, wind noise may be very loud. Use the comfort mode position when driving.

Auto-reverse function

WARNING

There are some small distances just before the closed position which cannot be detected. Make sure that all passengers have their hands, etc. inside the vehicle before closing the sunroof and sunshade.

The auto-reverse function enables the sunroof and sunshade to automatically reverse when something is caught in the sunroof and sunshade as it is closing. When the control unit detects an obstacle, the sunroof and sunshade will open immediately.

Depending on the environment or driving conditions, the auto-reverse function may activate if an impact or load similar to something being caught in the sunroof and sunshade occurs.

If the auto-reverse function activates consecutively or the 12-volt battery is discharged, the sunroof and sunshade may not close properly. In this case, push and hold the switch to the CLOSE position ④ to close the sunroof.

If the sunroof does not operate

If the sunroof and sunshade do not operate properly, perform the following procedure to initialise the operation system.

1. If the sunroof and sunshade are open, close them fully by repeatedly pushing the sunroof switch to the CLOSE ② and ④ position.
2. Push and hold the sunroof switch to the CLOSE ④ position for 10 seconds.
The sunroof will be tilted up and the sunshade will close slightly and then stop.
3. Release the sunroof switch once, and immediately push the sunroof switch again and hold it to the CLOSE position ④.

The sunroof and sunshade will move as follows:

Sunshade fully open → sunroof tilt down → sunroof fully open → sunroof fully close → sunshade fully close

4. Release the sunroof switch after the sunroof and sunshade stopped.
5. Check if the sunroof switch operates normally.

WARNING

The driver is always responsible for operating the sunroof properly, including the operation by all passengers. Failure to follow the warnings and instructions for proper use of the sunroof could result in serious injury or death.

- **Do not allow children to operate the sunroof. Improper operation by children may cause an accident. If children or**

others get caught in the sunroof, it could cause serious injury.

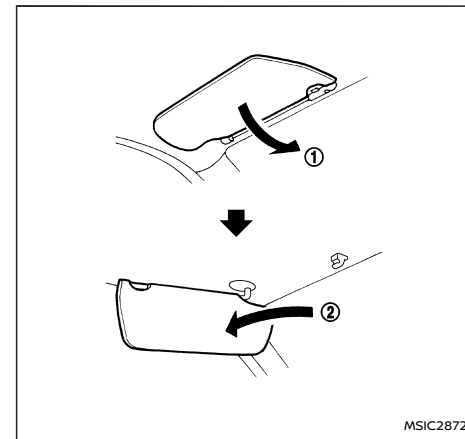
- To help avoid risk of injury or death through unintended operation of the sunroof, place the power switch in the OFF position when leaving the vehicle, and do not leave children and the Intelligent Key inside the vehicle.
- Do not activate the auto-reverse function intentionally. If hands or face, etc. get caught in the sunroof, it could cause serious injury.

CAUTION

- Do not place objects (such as newspapers, handkerchiefs, etc.) on the sunshade when it is extending or retracting causing improper operation or damage to the sunshade.
- Do not push the sunshade arm with your hands, etc., as this may deform it. Improper operation or damage to the sunshade may result.
- Do not put any object into the sunshade inlet port as this may result in improper operation or damage the sunshade.
- Do not hang any object on the arm rail as this may result in improper operation or damage the sunshade.
- Do not forcefully pull the sunshade. Doing so may elongate the sunshade. Improper operation or damage to the sunshade may result.

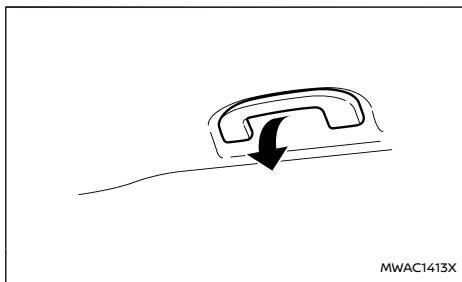
If the sunroof does not operate properly after performing the procedure above, have your vehicle checked by a NISSAN dealer or qualified workshop.

SUN VISORS



1. To block glare from the front, swing down the main sun visor ①.
2. To block glare from the side, remove the main sun visor from the centre mount and swing it to the side ②.

ASSIST GRIPS

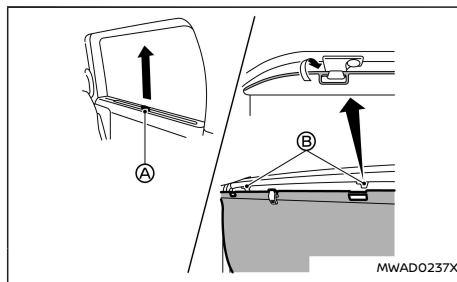


The assist grips are located above the front and rear side windows.

CAUTION

Do not use the assist grip when getting into or out of the vehicle. This may damage the assist grip and cause you to fall.

REAR SUNSHADE (where fitted)



CAUTION

- Do not release the rear sunshade during operation. This could damage the sunshade or cause injury.
- Do not forcefully pull the sunshade. Doing so may elongate the sunshade. This could cause improper operation or could damage the sunshade.
- Do not place objects on or near the rear sunshade. This could cause improper operation or could damage the sunshade.

The rear sunshades are equipped on the rear seat windows.

To raise the sunshade, pull the knob (A) up and hang the sunshade on the hooks (B).

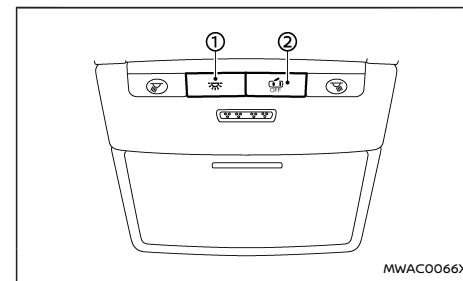
To store the sunshade, remove the sunshade from the hooks and lower it.

INTERIOR LIGHTS

CAUTION

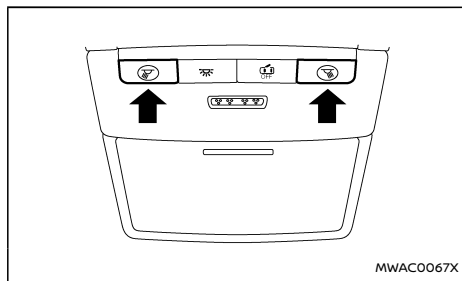
- Do not leave the light switch on when the e-POWER system is not running for extended periods of time to prevent the 12-volt battery from being discharged.
- Turn off the lights when you leave the vehicle.

INTERIOR LIGHT SWITCH



- ① The interior light can be turned ON regardless of door position. The light will go off after a period of time unless the power switch is placed in the ON position when any door is opened.
- ② The interior lights can be set to operate when the doors are opened. To turn off the interior lights when a door is open, push the switch, the interior lights will not illuminate, regardless of door position. The lights will go off when the power switch is placed in the ON position, or the driver's door is closed and locked.

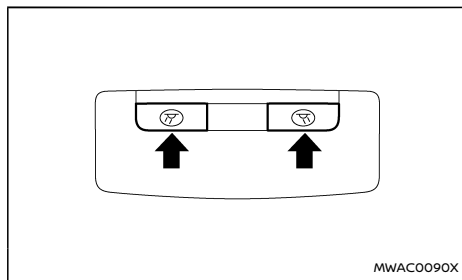
MAP LIGHTS



Push the button to turn the map lights on. To turn them off, push the button again.

The lights will also turn off after a period of time when the lights remain illuminated to prevent the 12-volt battery from becoming discharged.

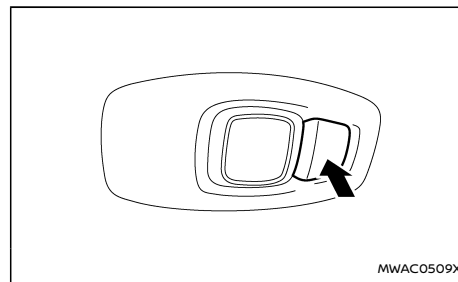
ROOM LIGHTS (where fitted)



Push the button to turn the room lights on. To turn them off, push the button again.

The lights will also turn off after a period of time when the lights remain illuminated to prevent the 12-volt battery from becoming discharged.

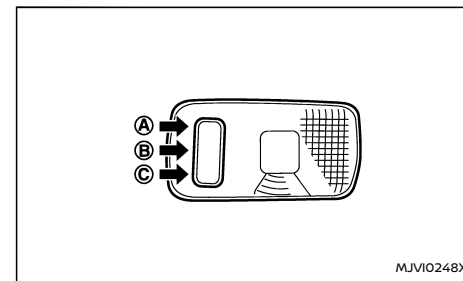
REAR PERSONAL LIGHTS (where fitted)



To turn the rear personal lights on, push the button. To turn them off, push the button again.

The lights will also turn off after a period of time when the lights remain illuminated to prevent the 12-volt battery from becoming discharged.

CARGO LIGHT



The cargo light has a three-position switch.

ON position

When the cargo light switch is in the ON position (A), the cargo light illuminates, regardless of any condition.

DOOR position

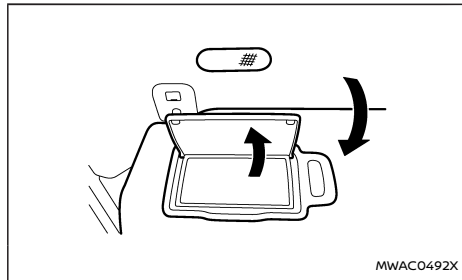
When the cargo light switch is in the DOOR position (B), the cargo light illuminates when the back door is opened.

OFF position

When the cargo light switch is in the OFF position (C), the cargo light does not illuminate, regardless of any condition.

The light will also turn off after a period of time when the light remains illuminated to prevent the 12-volt battery from becoming discharged.

VANITY MIRROR LIGHTS



Example

The light over the vanity mirror will turn on when the cover on the vanity mirror is opened.

When the cover is closed, the light will turn off.

The light will also turn off after a period of time when the light remains illuminated to prevent the 12-volt battery from becoming discharged.

MEMO

3 Pre-driving checks and adjustments

Keys	156	Motion-activated back door (where fitted)	176
Intelligent Key	156	Garage mode system (where fitted)	177
Doors	157	Auto closure (where fitted)	177
Super Lock system (where fitted)	157	Back door release lever	178
Locking with key	158	Fuel-filler lid	178
Unlocking with inside handle (where fitted)	158	Opening the fuel-filler lid	178
Locking with power door lock switch	158	How to refuel	178
Child safety rear door lock	159	When refuelling from a portable fuel container	179
Intelligent Key system	160	Steering wheel	180
Intelligent Key operating range	161	Tilt and telescopic operation	180
Door locks/unlocks precaution	161	Mirrors	181
Intelligent Key operation	162	Inside rearview mirror	181
Walk away lock function	164	Outside rearview mirrors	186
Approach unlock function	164	Vanity mirror	187
Battery saver system	164	Memory seat (where fitted)	187
Troubleshooting guide	166	Memory storage function	187
How to use remote keyless entry function	168	Entry/Exit function	188
Hazard indicator operation	170	System operation	188
Security system	171	Parking brake	189
Theft warning system (where fitted)	171	Automatic operation	189
NISSAN Anti-Theft System (NATS)	172	Manual operation	190
Bonnet	173	Automatic brake hold	191
Back door	174	How to activate/deactivate Automatic brake	
Operating manual back door (where fitted)	174	hold function	191
Operating power back door (where fitted)	174	How to use Automatic brake hold function	192

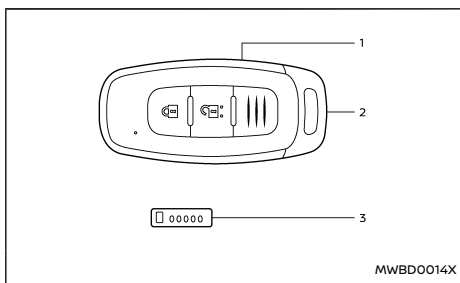
KEYS

Your vehicle can only be driven with the keys specific to your vehicle. A key number plate is supplied with your key. Record the key number and keep the key number plate in a safe place, except in the vehicle, in case of the need to duplicate the keys.

The key can only be duplicated using an original key or the original key number. The key number is required when you have lost all of the keys and do not have the original key to duplicate from. If the key is lost, or you need extra keys, provide an original key or the key number to a NISSAN dealer or qualified workshop.

CAUTION

Do not leave the keys inside the vehicle when leaving the vehicle.



Example

1. Intelligent Key (2)
2. Mechanical key (in the Intelligent Key) (2)
3. Key number plate (1)

INTELLIGENT KEY

Your vehicle can only be driven with the Intelligent Keys, which are registered to your vehicle's Intelligent Key system components and NISSAN Anti-Theft System (NATS*) components. As many as 4 Intelligent Keys can be registered and used with one vehicle. The new keys must be registered by a NISSAN dealer or qualified workshop prior to use with the Intelligent Key system and NATS of your vehicle. Since the registration process requires erasing all memory in the Intelligent Key components when registering new keys, be sure to take all Intelligent Keys that you have to the NISSAN dealer or qualified workshop.

*: immobiliser

CAUTION

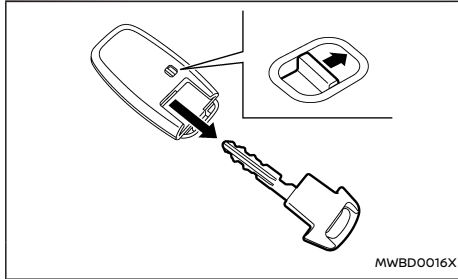
- Be sure to carry the Intelligent Key with you. Do not leave the vehicle with the Intelligent Key inside.
- Be sure to carry the Intelligent Key with you when driving. The Intelligent Key is a precision device with a built-in transmitter. To avoid damaging it, please note the following.
 - The Intelligent Key is water resistant; however, wetting may damage the Intelligent Key. If the Intelligent Key gets wet, immediately wipe until it is completely dry.
 - Do not bend, drop or strike it against another object.
 - If the outside temperature is below -10°C (14°F) degrees, the battery of the

Intelligent Key may not function properly.

- Do not place the Intelligent Key for an extended period in a place where temperatures exceed 60°C (140°F).
- Do not change or modify the Intelligent Key.
- Do not use a magnet key holder.
- Do not place the Intelligent Key near an electric appliance such as a television set, personal computer or mobile phone.
- Do not allow the Intelligent Key to come into contact with water or salt water, and do not wash it in a washing machine. This could affect the system function.
- If an Intelligent Key is lost or stolen, NISSAN recommends erasing the ID code of that Intelligent Key. This will prevent the Intelligent Key from unauthorised use to unlock the vehicle. For information regarding the erasing procedure, please contact a NISSAN dealer or qualified workshop

DOORS

Mechanical key



To remove the mechanical key, release the lock knob at the back of the Intelligent Key.

To install the mechanical key, firmly insert it into the Intelligent Key until the lock knob returns to the lock position.

Use the mechanical key to lock or unlock the driver's door. (See "Doors" (P.157).)

CAUTION

Always carry the mechanical key installed in the Intelligent Key.

⚠ WARNING

- Before opening any door, always look for and avoid oncoming traffic.
- To help avoid risk of injury or death through unintended operation of the vehicle and or its systems, including entrapment in windows or inadvertent door lock activation, do not leave children, people who require the assistance of others or pets unattended in your vehicle. Additionally, the temperature inside a closed vehicle on a warm day can quickly become high enough to cause a significant risk of injury or death to people and pets.

SUPER LOCK SYSTEM (where fitted)


⚠ WARNING

For Super Lock system equipped models, failure to follow the precautions below may lead to hazardous situations. Make sure the Super Lock system activation is always safely conducted.

- When the vehicle is occupied, never lock the doors with the Intelligent Key. Doing so will trap the occupants, since the Super Lock system prevents the doors from being opened from the inside of the vehicle.
- Only operate the Intelligent Key lock button when there is a clear view of the vehicle. This is to prevent anybody from

being trapped inside the vehicle through the Super Lock system activation.

Locking the doors with the Intelligent Key or the lock sensor (on the front door - where fitted) will lock all doors including the back door and activate the Super Lock system.

To activate the Super Lock system, double-press the LOCK  button on the Intelligent Key or lock the doors by double-pressing the lock sensor. Hazard indicator lights flash longer to indicate Super Lock activation.

This means that none of the doors can be opened from the inside in order to prevent theft.

The system will be released when the door is unlocked with the Intelligent Key or the capacitive unlock sensor (on the front door handles - where fitted).

The Super Lock system will not activate when the doors are locked with the power door lock switch.

Emergency situations

If the Super Lock system is activated due to a traffic accident or other unexpected circumstances while you are in the vehicle:

- Place the power switch in the ON position, the Super Lock system will be released and all the doors can be unlocked with the power door lock switch. You can then open the doors.
- Unlock the door using the Intelligent Key. The Super Lock system will be released and you can open the door.

- Open or break the driver's door window and then insert the key into the outside door key cylinder and turn it towards the rear of the vehicle. The driver's door will unlock and can be opened from inside the vehicle.

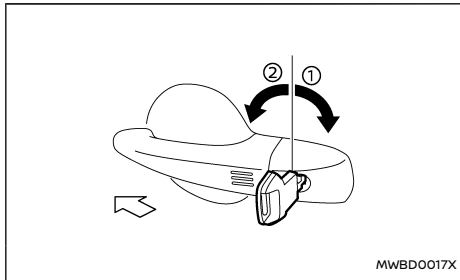
Locking without activating the Super Lock system

⚠ WARNING

Do not leave the key inside the vehicle when leaving the vehicle.

Locking the doors using the door key cylinder, or by a single press of the LOCK button on the Intelligent Key, or by a single press of lock sensor (where fitted) will not activate the Super Lock system.

LOCKING WITH KEY



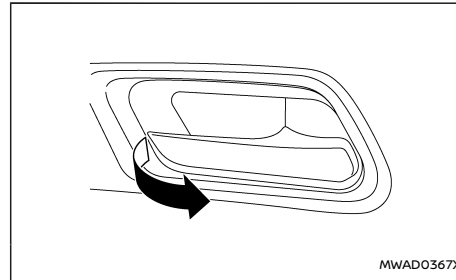
To lock the driver's door, turn the driver's door key cylinder to the rear of the vehicle ①.

Locking the driver's door will simultaneously lock all doors.

To unlock the driver's door, turn the driver's door key cylinder to the front of the vehicle ②.

You can also lock or unlock the other doors and the back door by using the Intelligent Key function. (See "Intelligent Key system" (P.160).)

UNLOCKING WITH INSIDE HANDLE (where fitted)



To unlock and open the door, pull the inside door handle as illustrated.

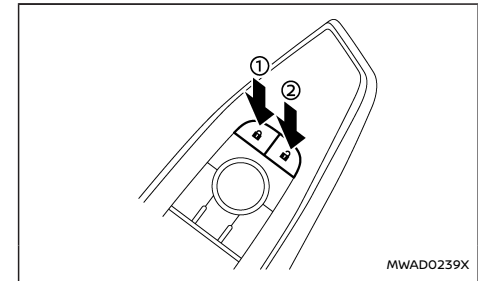
To switch the door unlock mode from one to another, push and hold the LOCK and UNLOCK button on the Intelligent Key or see "Vehicle Settings" (P.97).

- Selective door unlock mode
Only the corresponding door will be unlocked.
- All door unlock mode
 - Front inside door handle:
All doors will be unlocked.

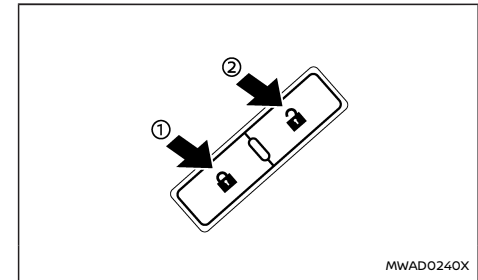
- Rear inside door handle:
Only the corresponding door will be unlocked.

The doors cannot be opened by using the inside door handle when the Super Lock system (where fitted) is activated.

LOCKING WITH POWER DOOR LOCK SWITCH




Driver's armrest



Front passenger's armrest

Operating the power door lock switch (located on the driver's and front passenger's doors) will lock or unlock all the doors.

To lock the doors, push the power door lock switch to the lock position ①.



The door lock indicator light  on the roof console comes on when the doors are locked.

To unlock the doors, push the power door lock switch to the unlock position ②.

CAUTION

Never leave the Intelligent Key in the vehicle when you leave the vehicle.

NOTE:

Models without the Super Lock system: If a door is manually opened from inside after having pressed the Intelligent Key LOCK  button, the door will unlock and the door lock indicator light  goes out.

Lockout protection

Lockout protection function helps to prevent the keys from being accidentally locked inside the vehicle.

When the power door lock switch is pushed to the lock position with any door open, all doors will not lock automatically and a chime will sound after the door is closed.

NOTE:

The doors may not lock when the Intelligent Key is in the same hand that is operating the lock sensor (where fitted) to lock the door. Put the



Intelligent Key in a purse, pocket or your other hand.

CAUTION

The lockout protection may not function under the following conditions:

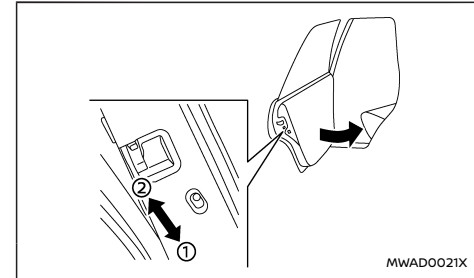
- **When the Intelligent Key is placed on top of the instrument panel.**
- **When the Intelligent Key is placed inside the glove box or a storage bin.**
- **When the Intelligent Key is placed inside the door pockets.**
- **When the Intelligent Key is placed inside or near metallic materials.**

Super Lock equipped models (RHD models)

If the doors are locked by double-pressing the Intelligent Key LOCK  button or by double-pressing a lock sensor (where fitted), the Super Lock system will be activated. The door lock indicator light  on the roof console comes on to indicate that all doors are locked, but it will not be possible to use the UNLOCK button of the power door lock switch to unlock the doors.

Locking the doors with the power door lock switch will not activate the Super Lock system.

CHILD SAFETY REAR DOOR LOCK

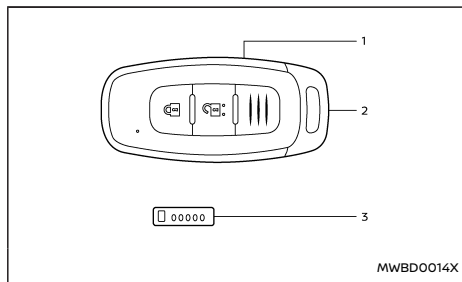


Child safety rear door locks help prevent the rear doors from being opened accidentally, especially when small children are in the vehicle.

When the levers are in the lock position ①, the rear doors can be opened only from the outside.

To disengage, move the levers to the unlock position ②.

INTELLIGENT KEY SYSTEM



Example

1. Intelligent Key (2)
2. Mechanical key (in the Intelligent Key) (2)
3. Key number plate (1)

⚠ WARNING

- **Radio waves could adversely affect electric medical equipment. Those who use a pacemaker should contact the electric medical equipment manufacturer for the possible influences before use.**
- **The Intelligent Key transmits radio waves when the buttons are pushed. The radio waves may affect aircraft navigation and communication systems. Do not operate the Intelligent Key while on an aeroplane. Make sure the buttons are not operated unintentionally when the unit is stored during a flight.**

The Intelligent Key system can operate all the door locks using the integrated key fob function, touching lock or capacitive unlock sensor (where

fitted) or pushing the request switch (where fitted) on the vehicle without taking the key out from a pocket or purse. The operating environment and/or conditions may affect the Intelligent Key system operation.

Be sure to read the following before using the Intelligent Key system.

CAUTION

- **Be sure to carry the Intelligent Key with you when operating the vehicle.**
- **Never leave the Intelligent Key in the vehicle when you leave the vehicle.**

The Intelligent Key is always communicating with the vehicle as it receives radio waves. The Intelligent Key system transmits weak radio waves. Environmental conditions may interfere with the operation of the Intelligent Key system under the following operating conditions.

- When operating near a location where strong radio waves/noises are transmitted, such as a TV tower, power station and broadcasting station.
- When in possession of wireless equipment, such as a mobile phone, transceiver, and CB radio.
- When the Intelligent Key is in contact with or covered by metallic materials.
- When any type of radio wave remote control is used nearby.
- When the Intelligent Key is placed near an electric appliance such as a personal computer.

- When the vehicle is parked near a parking meter.

In such cases, correct the operating conditions before using the Intelligent Key function or use the mechanical key.

Although the life of the battery varies depending on the operating conditions, the battery's life is approximately 2 years. If the battery is discharged, replace it with a new one.

When the Intelligent Key battery is low, an indicator illuminates in the vehicle information display. (See "4. [Key Battery Low] warning" (P.104).)

Since the Intelligent Key is continuously receiving radio waves, if the key is left near equipment which transmits strong radio waves/noises, such as signals from a TV and personal computer, the battery life may become shorter.

For information regarding replacement of a battery, see "Intelligent Key battery" (P.439).

As many as 4 Intelligent Keys can be registered and used with one vehicle. For information about the purchase and use of additional Intelligent Keys, it is recommended that you contact a NISSAN dealer or qualified workshop.

CAUTION

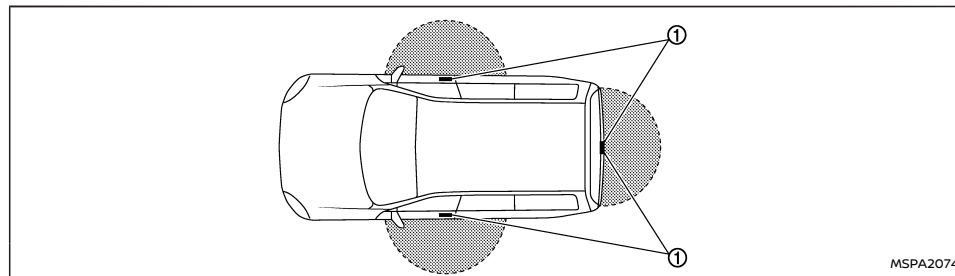
- **Do not allow the Intelligent Key, which contains electrical components, to come into contact with water or salt water. This could affect the system function.**
- **Do not drop the Intelligent Key.**
- **Do not strike the Intelligent Key sharply against another object.**

- Do not change or modify the Intelligent Key.
- Wetting may damage the Intelligent Key. If the Intelligent Key gets wet, immediately wipe until it is completely dry.
- If the outside temperature is below -10°C (14°F) degrees, the battery of the Intelligent Key may not function properly.
- Do not place the Intelligent Key for an extended period in an area where temperatures exceed 60°C (140°F).
- Do not attach the Intelligent Key with a key holder that contains a magnet.
- Do not place the Intelligent Key near equipment that produces a magnetic field, such as a TV, audio equipment, personal computers, mobile phone or wireless charger.

If an Intelligent Key is lost or stolen, NISSAN recommends erasing the ID code of that Intelligent Key from the vehicle. This may prevent the unauthorised use of the Intelligent Key to operate the vehicle. For information regarding the erasing procedure, it is recommended that you contact a NISSAN dealer or qualified workshop.

The Intelligent Key function can be disabled. For information about disabling the Intelligent Key function, it is recommended that you contact a NISSAN dealer or qualified workshop.

INTELLIGENT KEY OPERATING RANGE



MSPA2074

The Intelligent Key functions can only be used when the Intelligent Key is within the specified operating range from the lock or capacitive unlock sensors/request switch ①.

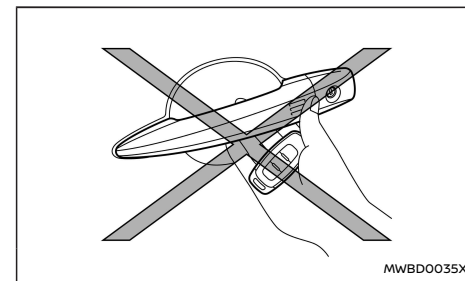
When the Intelligent Key battery is discharged or strong radio waves/noises are present near the operating location, the Intelligent Key system's operating range becomes narrower, and the Intelligent Key may not function properly.

The operating range is within 80 cm (31.50 in) from each sensor or request switch ①.

If the Intelligent Key is too close to the door glass, handle or rear bumper, the sensors or the request switch may not function.

When the Intelligent Key is within the operating range, it is possible for anyone who does not carry the Intelligent Key to use the lock or capacitive unlock sensors or request switch to lock/unlock the doors including the back door.

DOOR LOCKS/UNLOCKS PRECAUTION

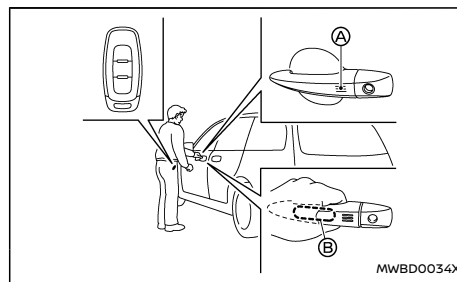
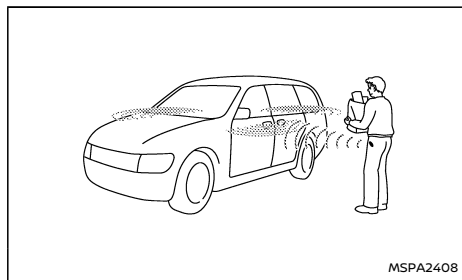


- Do not use the lock or capacitive unlock sensors or request switch with the Intelligent Key held in your hand as illustrated. The close distance to the door handle will cause the Intelligent Key system to have difficulty recog-

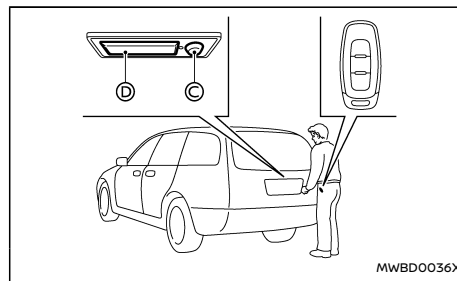
nising that the Intelligent Key is outside the vehicle.

- After locking with the lock sensors or the request switch, verify the doors are securely locked by testing them.
- To prevent the Intelligent Key from being left inside the vehicle, make sure you carry the key with you and then lock the doors.
- Do not pull the door handle before unlocking it by the capacitive unlock sensor or the request switch.

INTELLIGENT KEY OPERATION



Example



Example

You can lock or unlock the doors without taking the key out from your pocket or bag.

When you carry the Intelligent Key with you, you can lock or unlock all doors by using the lock sensor **A** (located on the front door handles) or back door request switch **C** within the range of operation.

When you lock or unlock the doors, the hazard

indicator will flash as a confirmation. For details, see "Hazard indicator operation" (P.170).

Welcome light and farewell light function

- When you lock or unlock the doors or the back door, the clearance lights and the tail lights will illuminate for a period of time.
- With the doors locked and when approaching or leaving the vehicle with the Intelligent Key, the clearance lights, tail lights and number plate lights illuminate (where fitted). (If you approach or leave the vehicle several times without unlocking the door, the light may not illuminate to prevent unintended activation of the function.)
- The welcome light and farewell light function can be disabled. For information about disabling the welcome light and farewell light function, see "Vehicle Settings" (P.97).

Locking doors

1. Push the P position switch to engage the P (Park) position. Place the power switch in the OFF position and make sure you carry the Intelligent Key with you.
2. Close all doors.
3. Touch the lock sensor **A** or push the back door request switch **C** while carrying the Intelligent Key with you.
4. All doors and the back door will lock.

For models with the Super Lock system:

To activate the Super Lock system, lock the doors by double-pressing the lock sensor **A**.

The hazard indicator lights flash longer to indicate Super Lock system activation.

NOTE:

- Lock sensors for all doors can be deactivated when the "I-Key Door Lock" is turned off in the Vehicle Setting of the vehicle information display. For additional information, see "Vehicle Settings" (P.97).
- Doors lock with the lock sensor or back door request switch while the power switch is not in the OFF position
- Doors do not lock by touching the driver's door lock sensor while the driver's door is open. However, doors lock with the mechanical key even if any door is open.
- Doors do not lock with the lock sensor or back door request switch with the Intelligent Key inside the vehicle and a beep sounds to warn you. However, when an Intelligent Key is inside the vehicle, doors can be locked with another Intelligent Key.
- Doors do not lock with the lock sensor while the e-POWER system is running.
- If the door handle becomes wet while the Intelligent Key is within the effective range, the door may lock and unlock repeatedly. In this case, follow the following correction procedures to wash the vehicle:
 - Place the Intelligent Key in a location 2 m (6 ft) or more away from the vehicle. (Take care to ensure that the key is not stolen.)
 - If the Intelligent Key is inside the vehicle and a door handle becomes wet during a car wash, a buzzer will sound outside the



vehicle. To turn off the alarm, take the Intelligent Key from inside the vehicle.

- The lock sensor may not work properly if it comes in contact with ice, snow, mud, etc. Clean the lock sensor and attempt to operate it again.
- If the door handle becomes wet, such as rain, the door may delay or prevent lock operation. In this case, try to touch firmly the sensor for at least 1 second.
- The lock sensor may not react immediately when the door handle gets wet from rain, etc. Keep touching the lock sensor until the doors lock, or touch the lock sensor after grasping the door handle.




CAUTION

- After locking the doors using the lock sensor or back door request switch, make sure that the doors have been securely locked by operating the door handles or the back door opener switch.
- When locking the doors using the lock sensor or back door request switch, make sure to have the Intelligent Key in your possession before operating the lock sensor or back door request switch to prevent the Intelligent Key from being left in the vehicle.
- The lock sensor or back door request switch is operational only when the Intelligent Key has been detected by the Intelligent Key system.



Unlocking doors

To switch the door unlock mode from one to another, push and hold the LOCK  and UNLOCK  button on the Intelligent Key or see "Vehicle Settings" (P.97).

Selective door unlock mode:

1. Carry the Intelligent Key with you.
2. Wrap the driver's or front passenger's door handle (capacitive unlock sensor)  or push the back door request switch .
3. Only the corresponding door will be unlocked.
4. Touch the lock sensor  within 5 seconds after releasing the door handle.
5. All doors will be unlocked.

All door unlock mode:

1. Carry the Intelligent Key with you.
2. Wrap the front door handle (capacitive unlock sensor)  or push the back door request switch .
3. All doors will be unlocked.
4. Operate the door handles to open the doors.


CAUTION

If a door handle is pulled while unlocking the doors, that door may not be unlocked. Returning the door handle to its original position will unlock the door. If the door does not unlock, after returning the door handle, touch the capacitive unlock sensor or push the request switch to unlock the door.


Automatic relock:

All doors will be locked automatically unless one of the following operations is performed within 30 seconds after touching the capacitive unlock sensor or pushing the request switch while the doors are locked.

- Opening any doors.
- Pushing the power switch.

If during the preset time period, the UNLOCK  button on the Intelligent Key is pushed, all doors will be locked automatically after another 30 seconds.

Opening back door

1. Carry the Intelligent Key.
2. Push the back door opener switch .
3. The back door will unlock and then open.

WALK AWAY LOCK FUNCTION

When you walk away from the vehicle with the Intelligent Key, the vehicle will be locked automatically by the walk away lock function. This function is disabled by the default setting. You can enable this function by the vehicle information display. For additional information, see "Vehicle Settings" (P.97).

NOTE:

- **When the doors are locked by the walk away lock function, the hazard indicator flashes once. Be sure to confirm the door locks before you leave the vehicle.**

- **The walk away lock function may not operate under the following conditions:**

- **When the door(s) and/or the back door are not closed securely.**
- **When the e-POWER system is running.**
- **When the Intelligent Key is placed inside of the vehicle.**
- **When you place the Intelligent Key outside of the vehicle for a period of time. (When a door is opened and closed, the walk away lock function will be reactivated.)**

APPROACH UNLOCK FUNCTION

When you approach the vehicle with the Intelligent Key, the vehicle (all the doors) will be unlocked automatically by the approach unlock function. This function is disabled by the default setting. You can enable this function by the vehicle information display. When this function is activated, selective unlock is disabled. For additional information, see "Vehicle Settings" (P.97).

NOTE:

- **When you approach the vehicle from the front, the approach unlock function may not operate unless you get close to the door.**
- **The approach unlock function may not operate under the following conditions:**
 - **When the Intelligent Key is placed inside of the vehicle.**
 - **When you place the Intelligent Key outside of the vehicle for a period of time. (When a door is unlocked and locked, the**

approach unlock function will be reactivated.)

- **When the engine is running.**
- **When 8 days have passed since the vehicle was locked.**
- **When you lock the vehicle with the power door lock switch.**
- **If the approach unlock function is activated while the selective unlock function is turned on, the selective unlock function is deactivated automatically. If the selective unlock function is activated while the approach unlock function is turned on, the approach unlock function is deactivated automatically.**

Once the approach unlock function is activated, the selective unlock function needs to be activated with the vehicle information display if you want to use the selective unlock function.

BATTERY SAVER SYSTEM

When the following condition is met for a period of time, the battery saver system will cut off the power supply to prevent 12-volt battery discharge.

- The power switch is in the ON position. (See "Power switch positions" (P.236).)

Warning lights and audible reminders

To help prevent the vehicle from moving unexpectedly by erroneous operation of the Intelligent Key listed on the following chart or to help prevent the vehicle from being stolen, chime or beep sounds inside and outside the vehicle and the

warning display appears on the vehicle information display.

When a chime or beep sounds or the warning display appears, be sure to check the vehicle and Intelligent Key.

See "Troubleshooting guide" (P.166) and "Vehicle information display" (P.92).

TROUBLESHOOTING GUIDE

Verify the location of all Intelligent Keys that are programmed for the vehicle. If another Intelligent Key is in range or inside the vehicle, the vehicle system may respond differently than expected.

Symptom		Possible cause	Action to take
When stopping the e-POWER system	The Shift to Park warning appears on the display and the inside warning chime sounds continuously.	The shift position is not in the P (Park) position.	Push the P position switch to engage the P (Park) position.
	[Press and Hold to Power Off] message appears on the display.	The Intelligent Key is not inside the vehicle.	Carry the Intelligent Key inside the vehicle and push the power switch once to stop the e-POWER system.
		There is not the Intelligent Key or the battery charge is low.	Rapidly push the power switch 3 consecutive times or push and hold the power switch for more than 2 seconds to stop the e-POWER system.
When opening the driver's door to get out of the vehicle	The door/back door open warning appears on the display.	The power switch is in the ON position.	Place the power switch in the OFF position.
When closing the door after getting out of the vehicle	The No key detected warning appears on the display, the outside chime sounds three times and the inside warning chime sounds for approximately 3 seconds.	The e-POWER system is running.	Place the power switch in the OFF position.
	The Rear Door Alert warning message (where fitted) appears on the display, the horn sounds three times, pauses, and sounds three more times, or a Check Rear Seat warning appears on the display.	The Rear Door Alert is activated.	Check the rear seat for all articles, clear the Rear Door Alert warning message by using the steering switches.
When touching the lock sensor (where fitted) or pushing the back door request switch to lock doors	The outside chime sounds for approximately 3 seconds.	The Intelligent Key is inside the vehicle.	Carry the Intelligent Key with you.
When pushing the power switch to start the e-POWER system	The Key Battery Low warning appears on the display.	The Intelligent Key battery charge is low.	Replace the battery with a new one. (See 'Intelligent Key battery' (P.439).)

	Symptom	Possible cause	Action to take
When pushing the power switch	The Key System Fault warning appears on the display.	It warns of a malfunction with the Intelligent Key system.	It is recommended that you contact a NISSAN dealer or qualified workshop.

HOW TO USE REMOTE KEYLESS ENTRY FUNCTION

⚠ WARNING

- Radio waves could adversely affect electric medical equipment. Those who use a pacemaker should contact the electric medical equipment manufacturer for the possible influences before use.
- The Intelligent Key transmits radio waves when the buttons are pushed. The radio waves may affect aircraft navigation and communication systems. Do not operate the Intelligent Key while on an aeroplane. Make sure the buttons are not operated unintentionally when the unit is stored during a flight.

CAUTION

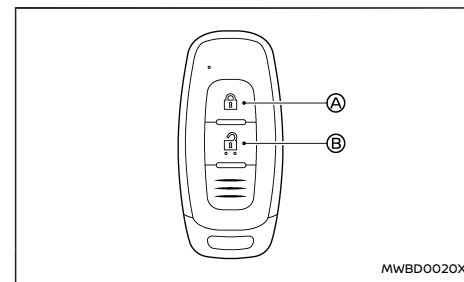
- Do not allow the Intelligent Key, which contains electrical components, to come into contact with water or salt water. This could affect the system function.
- Do not drop the Intelligent Key.
- Do not strike the Intelligent Key sharply against another object.
- Do not change or modify the Intelligent Key.
- Wetting may damage the Intelligent Key. If the Intelligent Key gets wet, immediately wipe until it is completely dry.
- If the outside temperature is below -10°C (14°F) degrees, the battery of the Intelligent Key may not function properly.

- Do not place the Intelligent Key for an extended period in an area where temperatures exceed 60°C (140°F).
- Do not attach the Intelligent Key with a key holder that contains a magnet.
- Do not place the Intelligent Key near equipment that produces a magnetic field, such as a TV, audio equipment, personal computers, mobile phone or wireless charger.

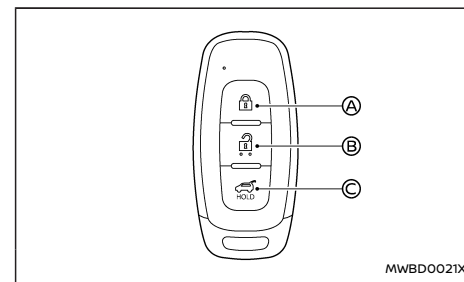
The remote keyless entry function can operate all door locks using the remote keyless entry function of the Intelligent Key. The remote keyless entry function can operate at a distance of approximately 1 m (3.3 ft) from the vehicle. (The operating distance depends upon the conditions around the vehicle.)

The remote keyless entry function will not operate:

- When the Intelligent Key is not within the operational range.
 - When the Intelligent Key battery is discharged.
- The remote keyless entry function can also operate the vehicle alarm.



Type A





Type B

- Ⓐ LOCK button
- Ⓑ UNLOCK button
- Ⓒ Power back door button





When you lock or unlock the doors or the back door, the hazard indicator will flash as a confirmation. For details, see "Hazard indicator operation" (P.170).

Locking doors





1. Place the power switch in the OFF position.
 2. Carry the Intelligent Key with you.*
 3. Close all the doors.
 4. Push the LOCK  button  on the Intelligent Key.
 5. All the doors and the back door will lock.
- *: Doors will lock with the Intelligent Key while the power switch is in the ON position.

Operate the door handles to confirm that the doors have been securely locked.

Unlocking doors

To switch the door unlock mode from one to another, push and hold the LOCK   and UNLOCK   buttons on the Intelligent Key or see "Vehicle Settings" (P.97).

Selective door unlock mode:



1. Push the UNLOCK  button  on the Intelligent Key.
2. The driver's door will be unlocked.
3. Push the UNLOCK  button  again within 5 seconds.
4. All doors will be unlocked.
5. Operate the door handles to open the doors.

All door unlock mode:

1. Push the UNLOCK  button  on the Intelligent Key.
2. All doors will be unlocked.

3. Operate the door handle to open the door.

Automatic relock:

All doors will be locked automatically unless one of the following operations is performed within 30 seconds after pushing the UNLOCK  button  while the doors are locked.



- Opening any door (including the back door).
- Pushing the power switch.



Opening or closing windows



The windows can be opened or closed with the Intelligent Key. This function will not operate while the window timer is activated or the windows need to be initialised.

See "Power windows" (P.146).



Opening:



To open the windows, push the UNLOCK  button  on the Intelligent Key for **about 3 seconds** after the door is unlocked.

To stop opening, release the UNLOCK  button .



If the window open operation is stopped on the way while pushing the UNLOCK  button , release and push the button again until the window opens completely.

Closing:



To close the windows, push the LOCK  button  on the Intelligent Key for **about 3 seconds** after the door is locked.

To stop closing, release the LOCK  button .



If the window close operation is stopped on the

way while pushing the LOCK  button , release and push the button again until the window closes completely.





Opening/closing back door (where fitted)

1. Push the power back door  button  for more than 1 second.
2. The back door will automatically open.

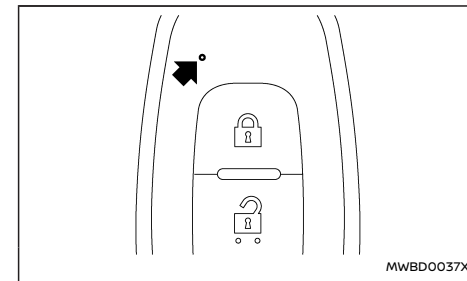
The outside chime sounds 3 times.

To close the back door, push the power back door  button  for more than 1 second.

The back door will automatically close.

If the  button  is pushed while the back door is being opened or closed, the back door will immediately stop. Pushing the  button  again will reverse the direction of the back door. However, when the back door is near the fully open position, it moves in the closing direction and when the back door is near the fully close position, it moves in the opening direction.

Intelligent Key button operation light



MWB0037X



The light blinks only when you push any button on the Intelligent Key. The light illumination only signifies that the Intelligent Key has transmitted a signal. You may look and/or listen to verify that the vehicle has performed the intended operation. If the light does not blink, your battery may be too weak to communicate to the vehicle. If this occurs, the battery may need to be replaced.

For additional information regarding the replacement of a battery, see "Intelligent Key battery" (P.439).

HAZARD INDICATOR OPERATION

When you lock or unlock the doors, the hazard indicator will flash as a confirmation.

The following descriptions show how the hazard indicator will activate when locking or unlocking the doors.

Operation	DOOR LOCK	DOOR UNLOCK
Touching the lock or capacitive unlock sensor or pushing back door request switch	HAZARD - once	HAZARD - twice
Walk away lock or approach unlock	HAZARD - once	HAZARD - twice
Pushing  or  button	HAZARD - once	HAZARD - twice

SECURITY SYSTEM

Your vehicle is equipped with the following security systems:

- Theft warning (where fitted)
- NISSAN Anti-theft System (NATS)*

(*: Immobiliser)

THEFT WARNING SYSTEM (where fitted)

The theft warning system provides visual and audio alarm signals if parts of the vehicle are disturbed.

For models with ultrasonic sensor and tilt sensor (where fitted)

How to activate system:

1. Close all windows and sunroof (where fitted).
2. Place the power switch in the OFF position.
3. Carry the Intelligent Key with you and get out of the vehicle.
4. Make sure the bonnet and the back door are closed. Close and lock all doors with the Intelligent Key, the lock sensor (on the front door handles) or the request switch.

If the bonnet is open, the buzzer will sound. The buzzer will stop when the bonnet is correctly closed.

Even when the driver and/or passengers are in the vehicle, the system will activate with all doors locked and the power switch off. Place the power switch in the ON position to turn the system off.

If the system malfunctions, the short beep sounds 5 times or the hazard indicator blinks

for about 10 seconds. Have the system checked by a NISSAN dealer or qualified workshop.

Theft warning system operation:


The warning system will give the following alarm:

- The hazard indicator lights blink and the horn sounds intermittently for approximately 30 seconds.
- The alarm automatically turns off after approximately 30 seconds. However, the alarm reactivates if the vehicle is tampered with again.

The alarm is activated when:

- operating the door or the back door without using the Intelligent Key, the capacitive unlock sensor (on the front door handles) or the request switch.
- opening the bonnet (where fitted).
- the volumetric sensing system (ultrasonic sensor) is triggered (when it is activated).
- the power supply is disconnected.
- the vehicle inclination is detected by the tilt sensor (when it is activated) (where fitted).

How to stop alarm:

- The alarm will stop by unlocking a door with the capacitive unlock sensor, the request switch or the UNLOCK  button on the Intelligent Key.
- The alarm will stop if the power switch is placed in the ON position.

Operation of the ultrasonic sensor and tilt sensor (where fitted):

The ultrasonic sensor (volumetric sensing) detects

movement in the passenger's compartment. The tilt sensor (where fitted) detects the vehicle inclination. When the theft warning system is set to the armed position, it will automatically switch on the ultrasonic sensor and tilt sensor (where fitted).

It is possible to exclude the ultrasonic sensor and tilt sensor (where fitted) (for example, when transporting the vehicle on a ferry).

To exclude the ultrasonic sensor and tilt sensor (where fitted):

1. Push the ◀ ▶ button on the steering wheel until [Settings] appears in the vehicle information display and then push the scroll dial. Use the scroll dial to select [Vehicle Settings]. Then push the scroll dial.
2. Select [Alarm System]. Then push the scroll dial. The following options are available:

- [Always ON]

When selected, the ultrasonic sensor and tilt sensor (where fitted) will activate each time the alarm is set.

- [Ask on Exit]

When selected, the system provides the choice to disable the ultrasonic sensor and tilt sensor (where fitted) after the power switch is placed in the OFF position.

- [Disable Once]

When selected, the ultrasonic sensor and tilt sensor (where fitted) will be disabled until the next time the power switch is placed in the ON position.

Select [Disable Once] or [Ask on Exit]. Then push the scroll dial.

3. Close the doors, bonnet and back door. Lock them using the Intelligent Key, the lock sensor or the request switch.

The ultrasonic sensor and tilt sensor (where fitted) are now excluded from the theft warning system. All other functions of the system remain activated until the theft warning system is disarmed again.

For models without ultrasonic sensor and tilt sensor (where fitted)

How to activate system:

1. Close all windows and sunroof (where fitted).

The system can be armed even if the windows are open.

2. Place the power switch in the OFF position.
3. Remove the Intelligent Key from the vehicle.
4. Close all doors, bonnet and back door. Lock all doors. The doors can be locked with the Intelligent Key, the lock sensor (on the front door handles), request switch, power door lock switch or mechanical key.

Even when the driver and/or passengers are in the vehicle, the system will activate with all doors, bonnet, and back door locked with the power switch in the OFF position. When placing the power switch in the ON position, the system will be released.

Theft warning system operation:


The vehicle security system will give the following alarm:

- The hazard indicator lights blink and the horn sounds intermittently.
- The alarm automatically turns off after approximately 27 seconds. However, the alarm reactivates if the vehicle is tampered with again.

The alarm is activated by:

- Unlocking the door or opening the back door without using the button on the Intelligent Key, the capacitive unlock sensor (on the front door handles) (where fitted), the request switch (where fitted) or the mechanical key. (Even if the door is opened by releasing the door inside lock knob, the alarm will activate.)
- Opening the bonnet.

How to stop alarm:

- The alarm will stop only by unlocking a door by pushing the UNLOCK  button on the Intelligent Key.
- The alarm will not stop if the power switch is placed in the ON position.

NISSAN ANTI-THEFT SYSTEM (NATS)

The NATS (NISSAN Anti-Theft System) will not allow the e-POWER system to start without the use of the registered key.

If the e-POWER system does not start using the registered Intelligent Key, it may be due to interference caused by:

- Another Intelligent Key.
- Automated toll road device.

- Automated payment device.
- Other devices that transmit similar signals.

Start the e-POWER system using the following procedure:

1. Remove any items that may be causing the interference away from the Intelligent Key.
2. Start the e-POWER system again.

If this procedure allows the e-POWER system to start, NISSAN recommends placing the registered Intelligent Key separate from other devices to avoid interference.

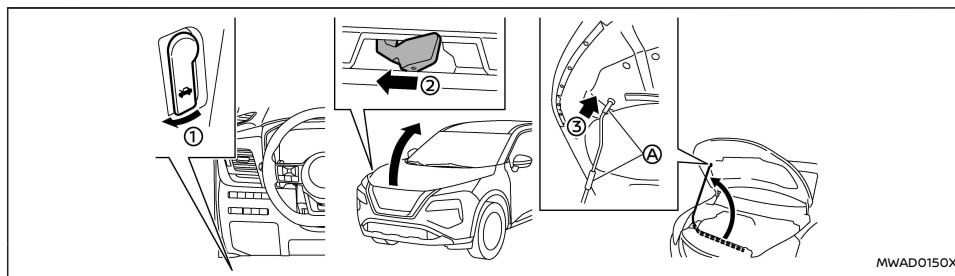
BONNET

⚠ WARNING

- Make sure the bonnet is completely closed and latched before driving. Failure to do so could cause the bonnet to fly open and result in an accident.
- Never open the bonnet if steam or smoke is coming from the engine compartment to avoid injury.

CAUTION

The engine will start if the bonnet is opened when the e-POWER system is running (to avoid accidents when performing maintenance).



MWAD0150X

1. Pull the bonnet lock release handle ① located below the driver's side instrument panel; the bonnet springs up slightly.
2. Push the lever ② underneath the front of the bonnet sideways as illustrated with your fingertips.
3. Raise the bonnet.
4. Remove the support rod and insert it into the slot ③.

Hold the coated parts ④ when removing or resetting the support rod. Avoid direct contact with the metal parts, as they may be hot immediately after the engine has been stopped.

When closing the bonnet:

1. While supporting the bonnet, return the support rod to its original position.
2. Slowly lower the bonnet to about 20 to 30 cm (8 to 12 in) above the bonnet lock, then let it drop.

BACK DOOR

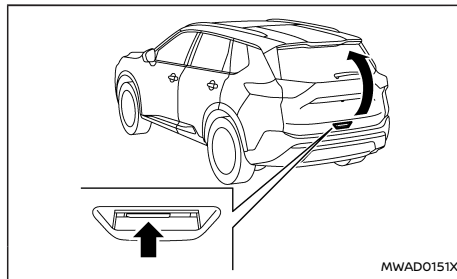
⚠ WARNING

- Always be sure the back door has been closed securely to prevent it from opening while driving.
- Do not drive with the back door open. This could allow dangerous exhaust gases to be drawn into the vehicle. For additional information, refer to “Exhaust gas (carbon monoxide)” (P.229).
- To help avoid risk of injury or death through unintended operation of the vehicle and or its systems, including entrapment in windows or inadvertent door lock activation, do not leave children, people who require the assistance of others or pets unattended in your vehicle. Additionally, the temperature inside a closed vehicle on a warm day can quickly become high enough to cause a significant risk of injury or death to people and pets.
- Always be sure that hands and feet are clear of the door frame to avoid injury while closing the back door.

CAUTION


Do not use accessory carriers that attach to the back door. Doing so will cause damage to the vehicle.

OPERATING MANUAL BACK DOOR (where fitted)



To open the back door, unlock it. Pull up the back door to open.

The back door can be unlocked by:

- pushing the UNLOCK  button on the Intelligent Key.
- pushing the back door request switch (where fitted).
- touching the capacitive unlock sensor (where fitted).

To close the back door, pull down until it securely locks.

OPERATING POWER BACK DOOR (where fitted)

To operate the power back door, the vehicle must be in the P (Park) position.

The power back door will not operate if the 12-volt battery voltage is low.

If the back door is open approximately 150 mm (5.9 in) or less from the fully closed position, power

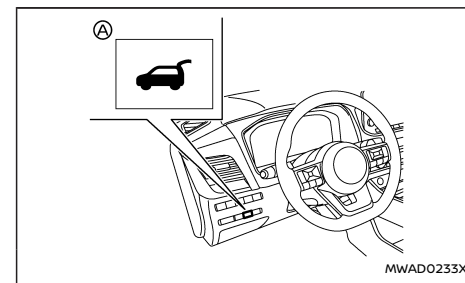
back door cannot be performed by any switch operations. To operate the power back door, manually close the back door.

The power back door operation can be activated or deactivated in the vehicle information display. (See “Vehicle Settings” (P.97).)

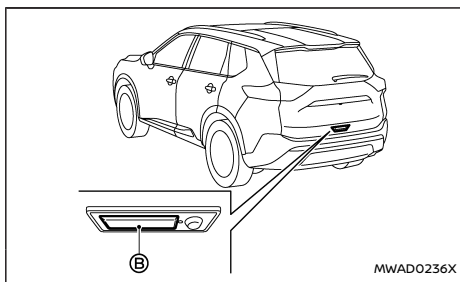
NOTE:

- For models with motion-activated back door: When washing, waxing or maintaining your vehicle, placing or replacing the body cover, splashing water to the area around the kick motion sensor, or using the tow bar (where fitted), turn off the power back door.
- If the power open or close operation is performed consecutively, the safety mode activates and the operation cannot be performed for a certain period of time. In this case, wait for a while and then perform the operation.

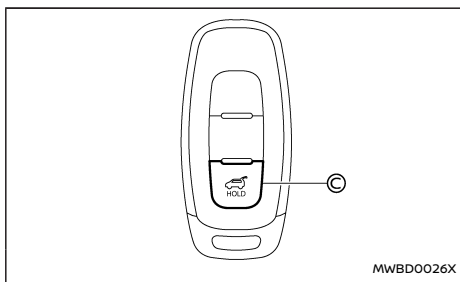
Power open (using switches)



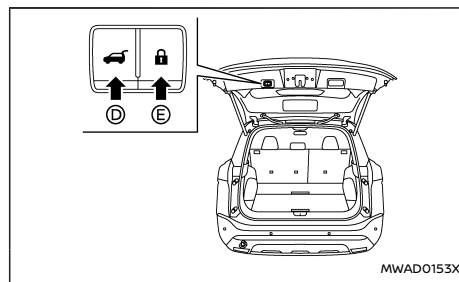
Power back door switch — Instrument panel



Back door opener switch



Power back door button - Key (example)



Power back door close and lock switches — Back door

When the back door is fully closed, the back door will fully open automatically by:

- pushing the power back door switch (A) on the instrument panel for more than 1 second
- pushing the back door opener switch (B)
- pushing the power back door button (C) on the key for more than 1 second

The outside chime sounds when the back door starts opening.

NOTE:

The back door can be opened by the power back door switch (A) or the power back door button (C) even if the back door is locked. The back door can be unlocked and opened independently of the other doors, even when they are locked. The back door must be unlocked (or the Intelligent Key must be within range) to open with the back door opener switch (B).

Power close (using switches)

When the back door is fully opened, the back door will fully close automatically by:

- pushing the power back door switch (A) on the instrument panel for more than 1 second
- pushing the power back door button (C) on the key for more than 1 second
- pushing the power back door close switch (D) on the lower part of the back door

The outside chime sounds when the back door starts closing.

Power close and lock

When the back door is fully opened and the Intelligent Key is carried with you near the back door, all the doors and the back door will lock and the back door will fully close automatically by pushing the power back door lock switch (E) on the lower part of the back door.

The outside chime sounds when the back door starts closing.

Stop and reverse function (where fitted)

The power back door will stop immediately if one of the following actions is performed during power open or close.

- pushing the power back door switch (A)
- pushing the back door opener switch (B)
- pushing the power back door close switch (D) on the lower part of the back door
- pushing the power back door button (C) on the key

And then the power back door will move in the

reverse direction if one of the above actions is performed again.

The outside chime sounds when the back door starts to reverse.

Auto reverse function

The auto-reverse function enables the back door to automatically reverse when something is caught in the back door as it is opening or closing. When the control unit detects an obstacle, the back door will reverse and stop.

If a second obstacle is detected, the back door motion will stop.

A pinch sensor is mounted on each side of the back door. If an obstacle is detected by the pinch sensor during power close, the back door will reverse and stop.

NOTE:

If the pinch sensor is damaged or removed, the power close function will not operate.

⚠ WARNING

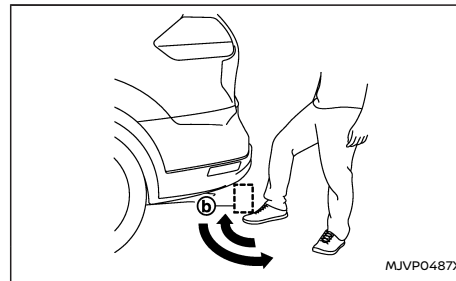
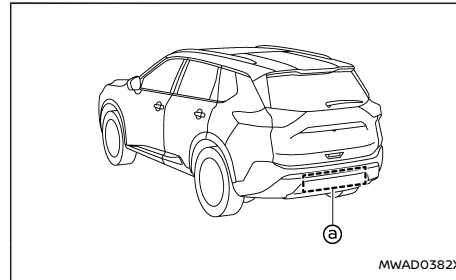
There is a small distance immediately before the closed position that cannot be detected. Make sure that all passengers keep their hands, etc., clear from the back door opening before closing the back door.

Manual mode

If power operation is not available, the back door can be operated manually. Power operation may not be available if the 12-volt battery voltage is low or if the back door is open approximately 150 mm

(5.9 in) or less from the fully closed position. When the power back door is turned off, the back door can be opened manually by pushing the back door opener switch. If the power back door opener switch is pushed during power open or close, the power operation will be cancelled and the back door can be operated manually. This will allow normal power operation functions to resume.

MOTION-ACTIVATED BACK DOOR (where fitted)



The back door can be operated using a quick kicking motion under the centre of the rear bumper.

The kick motion sensor (a) is located on the back of the rear bumper. When you move your foot under and then away from the operating range (b) similar to a kicking motion, while carrying the Intelligent Key with you, the back door will open or close automatically.

Proper operation technique



- While at the rear of the vehicle, begin making a quick forward kicking motion.
- Raise your foot straight under the centre of the rear bumper then immediately return your foot to the ground in a continuous motion.
- You do not need to hold your foot under the bumper or move it side to side. Immediately return your foot to the ground.
- The kicking motion should be straight, smooth and consistent.
- After your kick motion is complete, step back and allow the back door to open/close.
- Three beeps will sound and the back door will begin moving within 2 seconds after the kick.

⚠ WARNING

- **Prevent unintentional back door opening/closing. There may be conditions when opening/closing the back door is not desired. Keep the Intelligent Key out of range of the back door, (2 m (7 ft) or more) or inside the vehicle, when washing or working around the back of the vehicle, or when using the tow bar (where fitted).**

- Do not perform a kick motion near the tow bar, tongue or hitch receiver (where fitted). Doing so may cause injury.

NOTE:

- The kick motion sensor  may not function under the following conditions:
 - When operating near a location where strong radio waves are transmitted, such as a TV tower, power station or broadcasting station.
 - When the vehicle is parked near a parking meter.
- The power back door may not operate when your foot remains in the operating range .

CAUTION

- When the Intelligent Key is carried with you near the back door, even someone, who does not carry the Intelligent Key, may be able to open or close the back door with a kick motion.
- Do not perform a kick motion near the exhaust system components while they are hot. You may severely burn yourself.
- Do not perform a kick motion on an unstable place (for example, on a slope or a muddy ground, etc.).

Power open or close function

The back door will fully open automatically using the kick motion sensor.

1. Carry the Intelligent Key.
2. Move your foot under and away from the rear bumper similarly to a kicking motion within the operation range of the kick motion sensor.
3. The back door will automatically open or close.


Stop and reverse function

The power back door will stop immediately if a kick motion is performed during power open or close. The back door can be stopped even if you do not carry the Intelligent Key.

And then the power back door will move in the reverse direction if a kick motion is performed again. The power back door can be reversed when you carry the Intelligent Key.

GARAGE MODE SYSTEM (where fitted)

The back door can be set to open to a specific height by performing the following:

1. Open the back door.
2. Pull the back door down to the desired position and hold the back door (the back door will have some resistance when being manually adjusted).
3. While holding the back door in position, press and hold the power back door close switch  located on the back door for approximately 3 seconds or until 2 beeps are heard.

The back door will open to the selected position setting. To change the position of the back door, repeat steps 1-3 for setting the position of the back door.

CAUTION

Do not set the height of the back door below approximately 1/3 of the way to the floor using garage mode. Even if you set the height below approximately 1/3 of the way to the floor, the height will automatically be set to approximately 1/3 of the way to the floor.

AUTO CLOSURE (where fitted)

When the back door reaches the secondary position, the closure motor engages and pulls the back door to its primary latch position.

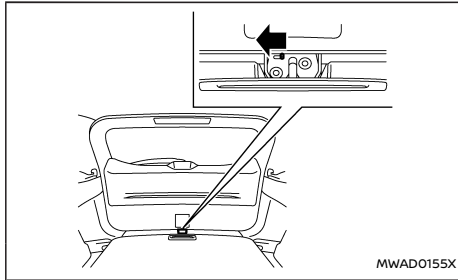
Do not apply excessive force when the auto closure is operating. Excessive force applied may cause the mechanism to malfunction.

CAUTION

- The back door will automatically close from the secondary position. To avoid pinching, keep hands and fingers away from back door opening.
- Do not let children operate the back door.

FUEL-FILLER LID

BACK DOOR RELEASE LEVER



If the back door cannot be opened due to a discharged 12-volt battery, follow these steps.

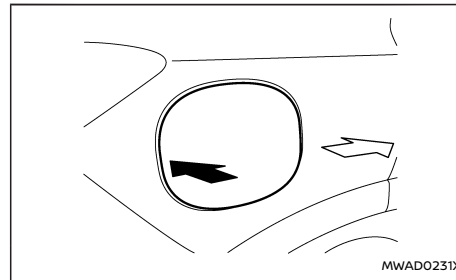
1. Fold the rear seats down. (See "Seats" (P.26).)
2. Insert a suitable tool in the access opening. Move the release lever to the left. The back door will be unlatched.
3. Push the back door up to open.

Contact a NISSAN dealer or qualified workshop as soon as possible for repair.

CAUTION

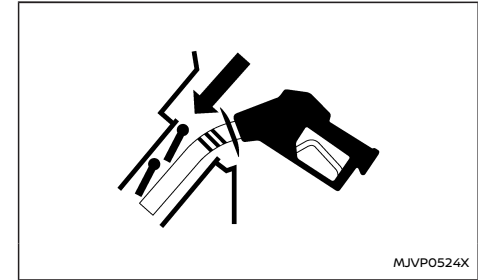
- Avoid applying direct water pressure, such as high-pressure sprayer, on or around the fuel-filler lid.
- Be sure to close the fuel-filler lid before using an automatic car wash or a high-pressured car wash.
- Never use fuel additives. Additives may cause damage to the engine.

OPENING THE FUEL-FILLER LID



To open the fuel-filler lid, push the middle left side of the lid.

HOW TO REFUEL



The fuel tank is not equipped with a fuel-filler cap. After opening the fuel-filler lid, insert the fuel pump nozzle directly into the fuel-filler opening. When the fuel pump nozzle is pulled out, the fuel-filler opening will be sealed.

To refuel:

Be sure to insert the fuel pump nozzle into the fuel-filler opening at one motion and as far as it will go before fuelling.

Never move the nozzle during refuelling.

Pull out the nozzle approximately 5 seconds after the fuel pump nozzle shuts off automatically (initial shut-off).

Close the fuel-filler lid after refuelling.

If you need to refuel from a portable fuel container, use the funnel supplied with your vehicle. (See "When refuelling from a portable fuel container" (P.179).)

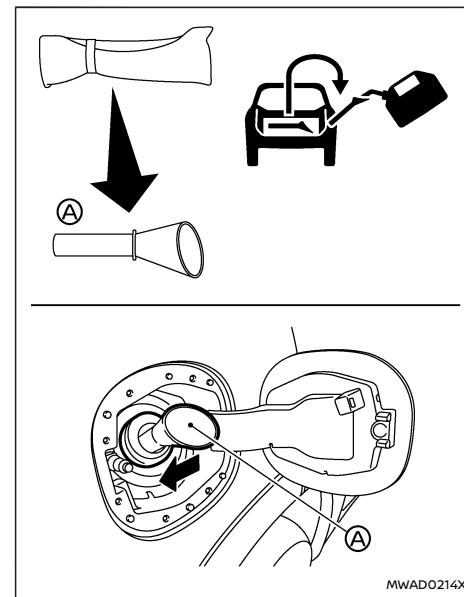
CAUTION

- Do not attempt to open the flaps on the fuel-filler opening using any tool other than the fuel pump nozzle.
- This fuel-filler opening is only conformable to normal fuel pump nozzles at gas stations. Using a nozzle with a small diameter may damage the opening and the fuel system.
- If fuel is spilled on the vehicle body, flush it away with water to avoid paint damage.

⚠ WARNING

- Petrol is extremely flammable and highly explosive under certain conditions. You could be burned or seriously injured if it is misused or mishandled. Always stop e-POWER system and do not smoke or allow open flames or sparks near the vehicle when refuelling.
- Do not attempt to top off the fuel tank after the fuel pump nozzle shuts off automatically. Continued refuelling may cause fuel overflow, resulting in fuel spray and possibly a fire.
- Never pour fuel into the throttle body to attempt to start your vehicle.
- Do not fill a portable fuel container in the vehicle. Static electricity can cause an explosion of flammable liquid, vapour or gas in any vehicle. To reduce the risk of serious injury or death when filling portable fuel containers:

- Always place the container on the ground when filling.
- Do not use electronic devices when filling.
- Keep the pump nozzle in contact with the container while you are filling it.
- Use only approved portable fuel containers for flammable liquid.

WHEN REFUELLING FROM A PORTABLE FUEL CONTAINER

If you need to refuel from a portable fuel container, use the funnel (A) stored in the tool bag (located under the luggage board).

Be sure to insert the funnel into the fuel-filler opening slowly and fully. Insert the nozzle of the portable fuel container into the opening along the funnel and fill the fuel tank.

STEERING WHEEL

After refuelling, remove the funnel from the fuel-filler opening. Wipe the funnel clean and return it to the tool bag.

CAUTION

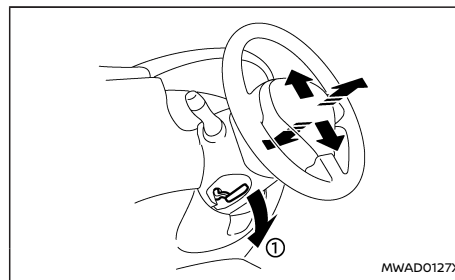
- Do not insert the nozzle of the portable fuel container directly into the fuel-filler opening. Doing so may damage the opening and the fuel system.
- Use only the funnel provided with your vehicle. Otherwise, the fuel-filler opening and the fuel system may be damaged.

⚠ WARNING

- Do not adjust the steering wheel while driving. You could lose control of your vehicle and cause an accident.
- Do not adjust the steering wheel any closer to you than is necessary for proper steering operation and comfort. The driver's air bag inflates with great force. If you are unrestrained, leaning forward, sitting sideways or out of position in any way, you are at greater risk of injury or death in a crash. You may also receive serious or fatal injuries from the air bag if you are up against it when it inflates. Always sit back against the seatback and as far away as practical from the steering wheel. Always use the seat belts.

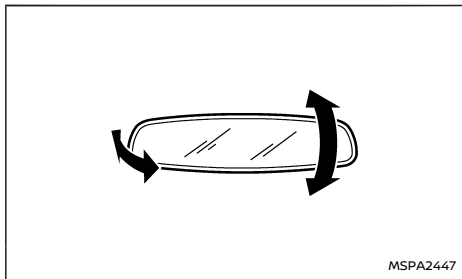
Pull the lock lever ① down and adjust the steering wheel up, down, forward or rearward to the desired position. Push the lock lever up securely to lock the steering wheel in place.

TILT AND TELESCOPIC OPERATION



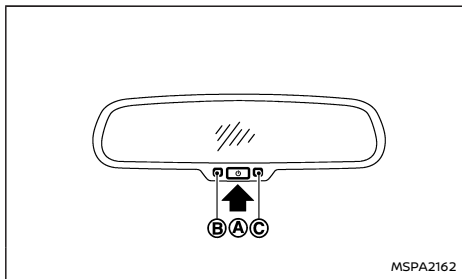
MIRRORS

INSIDE REARVIEW MIRROR



Adjust the angle of the inside rearview mirror to the desired position.

Automatic anti-glare type (where fitted)



The inside rearview mirror is designed so that it automatically changes reflection according to the intensity of the headlights of the following vehicle.

The anti-glare system will be automatically turned on when the power switch is placed in the ON position.

When the anti-glare system is turned on, the indicator light (B) will illuminate and excessive glare from the headlights of the vehicle behind you will be reduced.

Push the (A) switch (A) to make the inside rearview mirror operate normally. The indicator light will turn off. Push the (A) switch again to turn the system on.

Do not hang any objects on the mirror or apply glass cleaner. Doing so will reduce the sensitivity of the sensor (C), resulting in improper operation.

Intelligent Rear View Mirror (where fitted)

⚠ WARNING

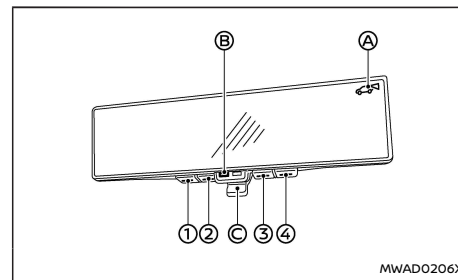
Failure to follow the warnings and instructions for proper use of the Intelligent Rear View Mirror could result in serious injury or death.

- The Intelligent Rear View Mirror is a convenience feature but it is not a substitute for proper vehicle operation. The system has areas where objects cannot be viewed. Check the blind spot of the Intelligent Rear View Mirror before vehicle operation. The driver is always responsible for safe driving.
- Do not disassemble or modify the Intelligent Rear View Mirror, the camera unit or wirings. If you do, it may result in accidents or fire. In case you notice smoke or smell coming from the Intelligent Rear View Mirror, stop using the system immediately. See a NISSAN dealer for servicing.
- Do not operate the Intelligent Rear View Mirror while driving. Doing so can be a distraction and it could lose control of your vehicle and cause an accident or serious injury.
- Do not gaze into the Intelligent Rear View Mirror display during driving. It may cause a distraction and it could lose control of your vehicle and cause an accident or serious injury. Gazing into the display screen during driving also can be a cause of carsick for passengers.
- Do not put a cigarette or flames to the Intelligent Rear View Mirror, the camera unit or wirings. It may cause a fire.
- Be sure to adjust the Intelligent Rear View Mirror before driving. Switch the system to the conventional rearview mirror mode and be properly seated on the driver's seat. Then adjust the rearview mirror so as to see the rear window properly. Driving without adjusting the rearview mirror may cause difficulty in watching the display at Intelligent Rear View Mirror mode (camera view mode) due to the reflection from the surface of the mirror.
- If the indicator light of the mirror turns off at the Intelligent Rear View Mirror mode (camera view mode), immediately switch the system to the conventional rearview mirror mode. If the indicator light does not illuminate after switching to the Intelligent

Rear View Mirror mode again, the system may malfunction. Have the system checked by a NISSAN dealer.

- If the Intelligent Rear View Mirror malfunctions, immediately switch the system to the conventional rearview mirror mode. Have the system checked by a NISSAN dealer.
- When strong light (for example, sunlight or high beams from following vehicles) enters the camera, a light beam or a glaring light may appear on the display screen of the Intelligent Rear View Mirror. In that case, switch the system to the conventional rearview mirror mode appropriately.
- If dirt, rain or snow accumulates on the exterior glass surface covering the camera, the Intelligent Rear View Mirror may not display objects clearly. Use of the rear window wiper/washer may improve visibility, but if not, switch the Intelligent Rear View Mirror to the conventional rearview mirror mode until a time the glass covering the camera can be cleaned.

Components:



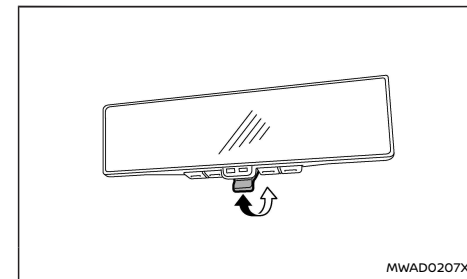
- ① MENU button
- ② Second button
- ③ Third button
- ④ Fourth button
- Ⓐ Indicator
- Ⓑ Indicator light
- Ⓒ Mode select lever

Intelligent Rear View Mirror provides a clear rearview from a camera located on the rear of the vehicle. Intelligent Rear View Mirror has two modes: conventional rearview mirror mode and Intelligent Rear View Mirror mode (camera view mode). You can switch these two modes by the mode select lever ③.

When the Intelligent Rear View Mirror mode is selected, the indicator Ⓐ is displayed, and the indicator light Ⓑ illuminates. (If a malfunction occurs in the Intelligent Rear View Mirror, the

indicator Ⓐ will turn off or not appear when the Intelligent Rear View Mirror mode is selected.)

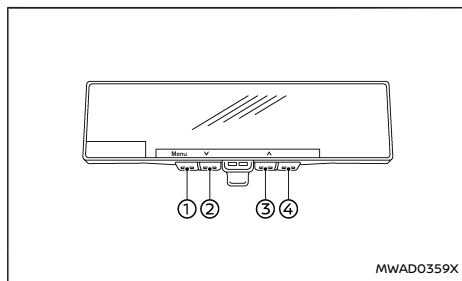
How to change the mode:



The mode can be switched when the power switch is in the ON position.

- Pull the mode select lever to switch to the Intelligent Rear View Mirror mode (camera view mode).
- Push the mode select lever to switch to the conventional rearview mirror mode.

How to make settings of Intelligent Rear View Mirror (MENU button operation):



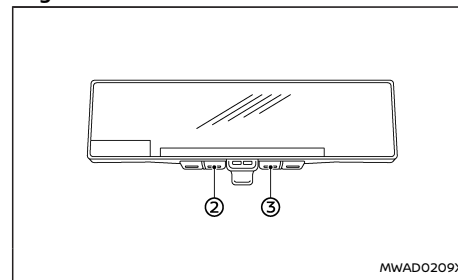
You can choose display settings of the Intelligent Rear View Mirror such as brightness, camera angle and textual indication ON or OFF.

When the Intelligent Rear View Mirror mode (camera view mode) is on, push the MENU button ① to display the setting menu. The following items can be adjusted:

- Brightness
- Down/Up
- Left/Right
- Rotation
- Indication
- Language
- Switch Backlight
- Licence

Push ② or ③ button to select an item and then push the ④ button.

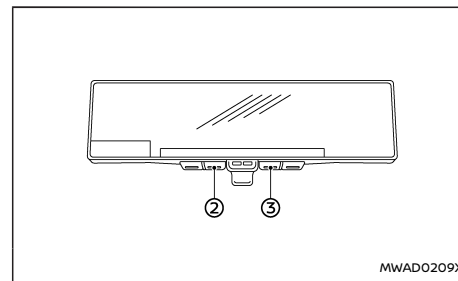
Brightness



The brightness of the display screen can be adjusted.

- Push the button ② to dim the screen.
- Push the button ③ to brighten the screen.

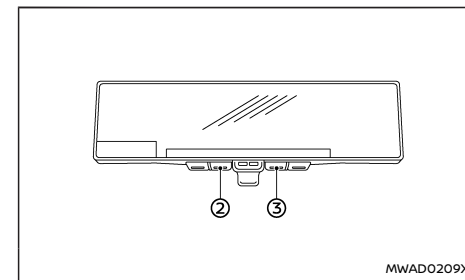
Down/Up



The vertical camera angle of the display screen can be adjusted.

- Push the button ② to down the camera angle.
- Push the button ③ to up the camera angle.

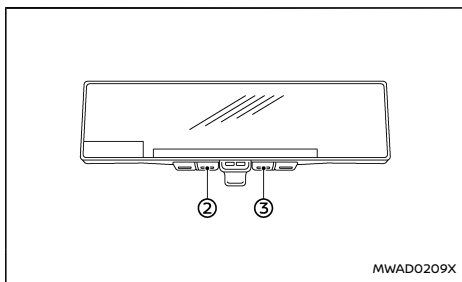
Left/Right



The horizontal camera angle of the display screen can be adjusted.

- Push the button ② to move the camera angle to the left.
- Push the button ③ to move the camera angle to the right.

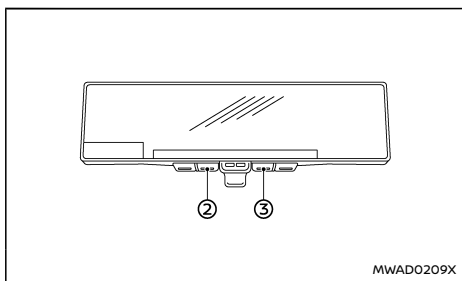
Rotation



The camera angle of the display screen can be rotated.

- Push the button ② to rotate the camera angle to the left.
- Push the button ③ to rotate the camera angle to the right.

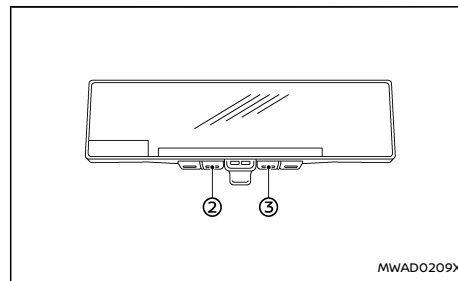
Indication



The textual indication can be turned on or off on the Intelligent Rear View Mirror display screen.

- Push the button ② to disable the textual indication on the display screen.
- Push the button ③ to enable the textual indication on the display screen.

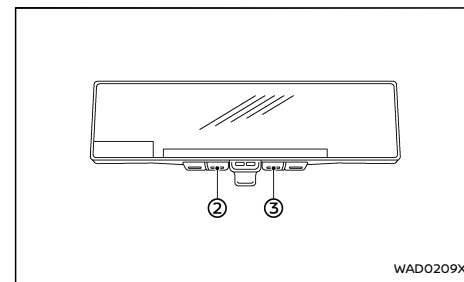
Language



You can select the language of the textual indication on the Intelligent Rear View Mirror display screen.

Select the language by using the ② or ③ button. The language setting will be retained even if the e-POWER system is restarted.

Switch Backlight



The illumination of the buttons can be turned on or off.

- Push the button ② to turn off the illumination.
- Push the button ③ to turn on the illumination.

Licence

The licence information is displayed.

Intelligent Rear View Mirror system precautions:

NOTE:

- **Long-term use of this system in stopping e-POWER system may cause battery to be discharged.**
- **Do not attach an antenna of wireless device near the Intelligent Rear View Mirror. Electric wave from wireless device may cause disturbed image in the Intelligent Rear View Mirror.**
- **Do not push the buttons excessively or operating the lever roughly may cause a system failure or the Intelligent Rear View Mirror itself to drop.**

- Never turn the body of Intelligent Rear View Mirror horizontally by 20° or more, or vertically by 30° or more. It may damage the Intelligent Rear View Mirror.
- Do not apply strong shocks to the body of Intelligent Rear View Mirror. It may cause a system failure.
- Do not apply heavy load to the camera and camera-cover on the rear of the vehicle. It may cause the camera to be removed or may cause a system failure.
- If it is difficult to see the Intelligent Rear View Mirror display screen because of a strong external light, switch the mode to the conventional rearview mirror mode for better use.
- When LED headlights are viewed on the Intelligent Rear View Mirror display, the images may flicker. This is normal.
- Due to diffused reflection from external environment, images on the screen may flicker. This is not a malfunction.
- A quick movement of a thing may not be able to display on the camera view screen. This is not a malfunction.
- Turn on the headlights at twilight or in a tunnel, etc. When headlights are turned on, the display and the camera systems automatically switched to the night mode, which can prevent dazzling.
- The Intelligent Rear View Mirror mode (camera view mode) display is different from the conventional rearview mirror. Objects in the display may differ from actual distance. Do

not solely rely on the Intelligent Rear View Mirror. Always rely on your own operation to avoid accidents.

- Immediately after the Intelligent Rear View Mirror is switched from one mode to another, you may have difficulty in focusing on the image in the mirror/display screen with your eyes. Be cautious using the Intelligent Rear View Mirror until your eyes get accustomed to the selected mode. If it is necessary to correct eye focusing, the use of multifocal glasses, etc. is recommended.
- It may take time for you to focus on the camera view display depending on your condition.
- If the brightness of the camera view display is adjusted to excessive bright level, it may cause an eyestrain in the driving. Adjust the brightness properly.
- Use the rear window wiper when it rains. If the camera view image is still unclear when the rear window wiper is in operation, check the deterioration of the rear window wiper blade.
- When using the rear window wiper, images on the screen may flicker. This is not a malfunction.
- Defog the rear window with defogger when rear window is fogged. Use the conventional rearview mirror mode until the rear window is fully defogged.
- The display of the Intelligent Rear View Mirror may become hot. This is not a malfunction.

- The colour of an object in the distance or in the dark may be difficult to be recognised. This is not a malfunction.
- When the temperature is high, the brightness may be decreased or image may not be displayed on the camera view display. This is not a malfunction.
- When the temperature is low, the image may be distorted on the camera view display. This is not a malfunction.

System maintenance (Intelligent Rear View Mirror):

- Always keep the mirror and camera area of the rear window clean.
- Clean the mirror and the camera lens with a dry soft cloth.
- When cleaning the camera area of the rear window, use a soft cloth dampened with water and a few neutral detergent. And after that, dry it up with dry soft cloth.
- If the image on the Intelligent Rear View Mirror display screen is still unclear even after cleaning the camera area of the rear window, an oil film may be adhering to the rear window glass. Clean the rear window glass with an oil film remover.
- Never use alcohol, benzine, thinner, or any similar material to clean the mirror or camera lens. It will cause a discoloration, deterioration or a system malfunction.
- Do not cover the front of the mirror. It may interfere with brightness adjustment or switching images on the camera view display.

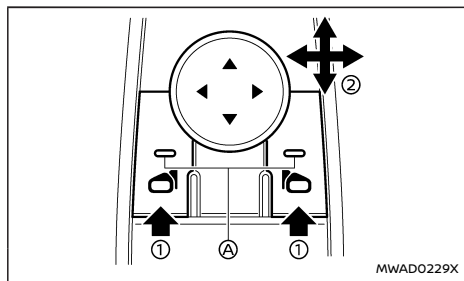
- Do not attach a sticker (including transparent material) on the camera area of the rear window.

OUTSIDE REARVIEW MIRRORS

⚠ WARNING

- Never touch the outside rearview mirrors while they are in motion. Doing so may pinch your fingers or damage the mirror.
- Never drive the vehicle with the outside rearview mirrors folded. This reduces rear view visibility and may lead to an accident.
- Objects viewed in the outside mirror are closer than they appear (where fitted).
- The picture dimensions and distance in the outside mirrors are not real.

Adjusting



The outside rearview mirror control switch is located on the driver's armrest.

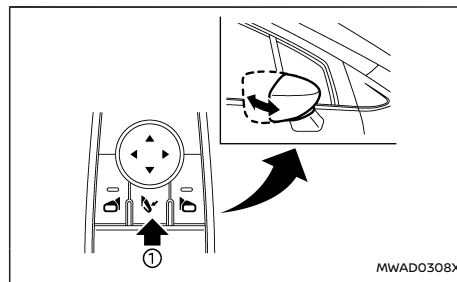
The outside rearview mirror will operate when the power switch is in the ON position.

Push either the right or left switch to select the right or left side mirror ① (the indicator light ④ on the selected mirror switch illuminates), then adjust ② using the control switch.

Defogging

The outside rearview mirrors will be heated when the rear window defogger switch is operated. (See "Defogger switch" (P.132).)

Folding



The outside rearview mirror remote control operates when the power switch is in the ON position.

The outside rearview mirrors automatically fold when the outside rearview mirror folding switch ① is pushed in. To unfold, push the switch again.

CAUTION

- Continuously performing the fold/unfold operation of the outside rearview mirror may cause the switch to stop the operation.
- Do not touch the mirrors while they are moving. Your hand may be pinched, and the mirror may malfunction.
- Do not drive with the mirrors stored. You will be unable to see behind the vehicle.
- If the mirrors were folded or unfolded by hand, there is a chance that the mirror will move forward or backward during driving. If the mirrors were folded or unfolded by hand, be sure to adjust them again electrically before driving.

Automatic fold:

The outside rearview mirrors automatically fold when the doors are locked with the Intelligent Key, the lock sensors (where fitted) or the request switch (where fitted). The mirrors unfold when the doors are unlocked with the Intelligent Key, the capacitive unlock sensors (where fitted) or the request switch (where fitted), or when the power switch is placed in the ON position.

Reverse tilt-down feature (where fitted)

When reversing the vehicle, the outside mirror will turn downward automatically to provide better rear visibility. Depending on the model, the outside mirror on one side (selected) or both sides will move.

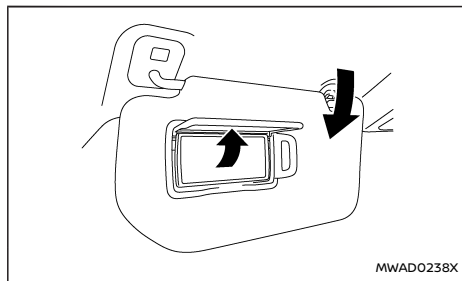
MEMORY SEAT (where fitted)

1. Place the power switch in the ON position.
2. Move the shift lever to the R (Reverse) position.
3. Choose the right or left outside mirror by operating the outside mirror control switch.
4. The outside mirror surface moves downward.

When one of the following conditions has occurred, the outside mirror surface will return to its original position.

- The shift lever is moved out of the R (Reverse) position.
- The vehicle speed exceeds 8 km/h (5 MPH).
- The selected outside mirror is deselected using the outside mirror control switch.
- The power switch is placed in the OFF position.
- The e-POWER system is stopped.

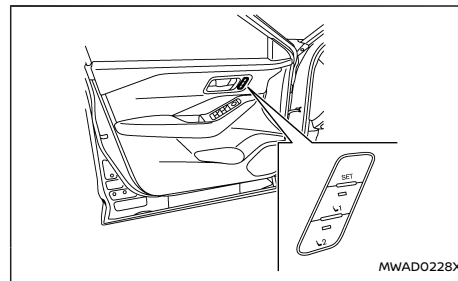
VANITY MIRROR



To use the vanity mirror, pull down the sun visor and pull up the cover.

The Memory seat system has the following features:

- Memory storage function
- Entry/exit function



SET/memory switches (driver's side shown; passenger side similar)

MEMORY STORAGE FUNCTION

Two positions for the driver's seat, front passenger's seat (where fitted) and outside mirrors (where fitted) can be stored in the memory switch. Follow these procedures to use the memory system.

1. Adjust the driver's seat or the front passenger's seat (where fitted) and outside mirrors (where fitted) to the desired positions by manually operating each adjusting switch. For additional information, refer to "Seats" (P.26) and "Outside rearview mirrors" (P.186).
2. Push the SET switch and, within 5 seconds, push the memory switch (1 or 2).

3. The indicator light for the pushed memory switch will come on and stay on for approximately 5 seconds.
4. The chime will sound if the memory has been stored.

NOTE:

If a new memory position is stored in the same memory switch, the previous memory position will be overwritten by the new stored position.

Confirming memory storage

Push the SET switch. If a memory position has not been stored in the switch (1 or 2) the indicator light for the respective switch will come ON for approximately 0.5 seconds. If a memory position has been stored in the switch (1 or 2) then the indicator light for the respective switch will stay ON for approximately 5 seconds.

Recalling switch memory positions

To recall the manually stored positions, push the memory switch (1 or 2). The driver's seat, front passenger's seat (where fitted) and the outside mirrors (where fitted) will move to the positions stored in the memory switch.

Linking log-in function to a stored memory position (models with navigation system)

The log-in function can be linked to a stored memory position with the following procedure.

1. Place the power switch in the ON position while carrying the Intelligent Key that was registered to the vehicle with a log-in function.

NOTE:



Make sure the Intelligent Key is far apart. Otherwise, the vehicle may detect the wrong Intelligent Key.


- Adjust the position of the driver's seat and outside mirrors (where fitted). (See "Seats" (P.26) and "Outside rearview mirrors" (P.186).)
- Place the power switch in the OFF position.

The next time you log in (selecting the user on the display) after placing the power switch in the ON position while carrying the Intelligent Key, the system will automatically adjust to the memorised driving position. (See the separate NissanConnect Owner's Manual.)

Linking an Intelligent Key to a stored memory position (models without navigation system)

Each Intelligent Key can be linked to a stored memory position (memory switch 1 or 2) with the following procedure.

- Follow steps 1-3 in the "Memory storage function" (P.187) for storing the memory position.
- The indicator light for the pushed memory switch will come on. While the indicator light is on for 5 seconds, push the LOCK  button and the UNLOCK  button on the Intelligent Key in succession. The indicator light of the linked memory switch will blink. After the indicator light goes off, the Intelligent Key is linked to that memory setting.

Once it is linked, when power switch is placed in the OFF position, pushing the UNLOCK  button

on the Intelligent Key will move the driver's seat and outside mirrors (where fitted) to the linked memory switch position.

NOTE:

If a new memory position is stored in the linked memory switch, then the Intelligent Key will link the new position and overwrites the previous position.

ENTRY/EXIT FUNCTION

This system is designed so that the driver's seat will automatically move when the shift position is in the P (Park) position. This allows the driver to get into and out of the driver's seat more easily.

The driver's seat will slide backward:

- When the driver's door is opened with the power switch placed in the OFF position.
- When the power switch is changed from ON to OFF with the driver's door open.

The driver's seat will return to the previous position:

- When the power switch is placed in the ON position while the shift position is in the P (Park) position.

The entry/exit function can be cancelled through [Vehicle Settings] in the vehicle information display by performing the following:

- Switch the [Exit Seat Slide] from ON to OFF. For additional information, refer to "Vehicle Settings" (P.97).

SYSTEM OPERATION

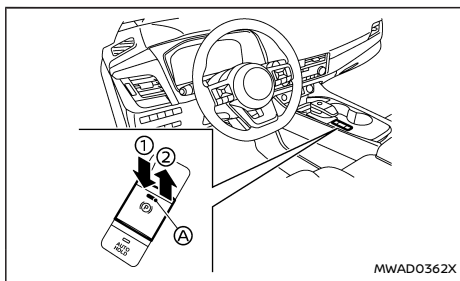
The memory seat system will not work or will stop operating under the following conditions:

- When the vehicle speed is above 7 km/h (4 MPH).
- When any of the memory switches are pushed while the memory seat system is operating.
- When the switch for the driver's seat is pushed while the memory seat system is operating.
- When the seat has already been moved to the memorised position.
- When no seat position is stored in the memory switch.
- When the shift lever is moved from P (Park) to any other position.

PARKING BRAKE

⚠ WARNING

- Never drive the vehicle with the parking brake applied. The brake will overheat and fail to operate and will lead to an accident.
- Never release the parking brake from outside the vehicle. If the vehicle moves, it will be impossible to push the footbrake pedal and will lead to an accident.
- Never use the shift lever in place of the parking brake. When parking, be sure the parking brake is fully applied.
- To help avoid risk of injury or death through unintended operation of the vehicle and/or its systems, do not leave children, people who require the assistance of others or pets unattended in your vehicle. Additionally, the temperature inside a closed vehicle on a warm day can quickly become high enough to cause a significant risk of injury or death to people and pets.



- ① Release
 - ② Apply
- Ⓐ Indicator light

The electronic parking brake can be applied or released automatically or by operating the parking brake switch.

AUTOMATIC OPERATION

The electronic parking brake is automatically released as soon as the vehicle starts while the accelerator pedal is depressed under the following conditions.

- While the e-POWER system is running.
- When the shift position is in the D (Drive) or R (Reverse) position.
- When the driver's door is closed.

The electronic parking brake is automatically released within 5 seconds after the shift position is placed in the D (Drive) or R (Reverse) position even if the driver's door is opened. Be sure to close the door before starting the vehicle.

⚠ WARNING

- Without the vehicle stationary, the electronic parking brake will not be automatically applied even if the e-POWER system is turned off with the power switch.
- Before leaving the vehicle, place the shift position in the P (Park) position and check that the electronic parking brake warning light is illuminated to confirm that the electronic parking brake is applied. The electronic parking brake warning light will

remain on for a period of time after the driver's door is locked.

CAUTION

When parking in an area where the outside temperature is below 0°C (32°F), the electronic parking brake, if applied, may freeze in place and may be difficult to release.

For safe parking, it is recommended that you place the shift position in the P (Park) position and securely block the wheels.

NOTE:

- To keep the electronic parking brake released after the e-POWER system is turned off, place the power switch in the OFF position, depress the brake pedal and push down the parking brake switch before opening the driver's door.
- If a malfunction occurs in the electronic parking brake system (for example, due to 12-volt battery discharge), it is recommended to contact a NISSAN dealer or qualified workshop.
- Under the following conditions, the electronic parking brake will automatically be applied and the braking force of Automatic brake hold will be released.

Automatic brake hold indicator light turns off.

- The braking force is applied by Automatic brake hold function for 3 minutes or longer.

- The vehicle is in the P (Park) position.
- Electric parking brake is applied manually.
- The driver's seat belt is unfastened.
- The driver's door is opened.
- The power switch is placed in the OFF position.
- A malfunction occurs in Automatic brake hold function.
- **Make sure that the electronic parking brake system warning light is OFF before starting the vehicle.**

MANUAL OPERATION

To apply: When the vehicle is stopped, pull the parking brake switch ② up. (The electronic parking brake will apply even if the power switch is placed in the OFF position.) The indicator light ④ on the switch and the electronic parking brake warning light ③ (red) will illuminate.

To release: With the power switch in the ON position, depress the brake pedal and push the parking brake switch down ①. The indicator light ④ and the electronic parking brake warning light (red) will turn off.

Before driving, check that the electronic parking brake warning light (red) turns off. For additional information, see "Warning lights, indicator lights and audible reminders" (P.83).

NOTE:

- **While the electronic parking brake is applied or released, an operating sound is heard from the lower side of the rear seat. This is normal and does not indicate a malfunction.**
- **When the electronic parking brake is frequently applied and released in a short period of time, the electronic parking brake system warning light may blink and the electronic parking brake may not operate in order to prevent the electronic parking brake system from overheating. If this occurs, operate the parking brake switch again after waiting approximately 1 minute.**
- **If the electronic parking brake must be applied while driving in an emergency, pull up and hold the parking brake switch. When you release the parking brake switch, the electronic parking brake will be released.**
- **While pulling up the parking brake switch during driving, the electronic parking brake is applied and a chime sounds. The electronic parking brake warning light (red) and the indicator light on the parking brake switch illuminate. This does not indicate a malfunction. The electronic parking brake warning light (red) and the indicator light on the parking brake switch will turn off when the electronic parking brake is released.**
- **When pulling the parking brake switch up with the power switch in the OFF position, the indicator light on the parking brake switch will continue to illuminate for a short period of time.**

When towing a trailer

Depending on the weight of the vehicle and trailer and the steepness of the slope, there may be a tendency for the vehicle to move backwards when starting from a standstill. When this occurs, you can use the parking brake switch in the same way as a conventional lever type parking brake.

Before starting on sloping roads when towing a trailer, be sure to read the following to prevent the vehicle from moving backward unintentionally.

- **Release the parking brake switch as soon as the e-POWER system is delivering enough torque to the wheels.**

AUTOMATIC BRAKE HOLD

Automatic brake hold function maintains the braking force without the driver having to depress the brake pedal when the vehicle is stopped at a traffic light or intersection. As soon as the driver depresses the accelerator pedal again, Automatic brake hold function is deactivated and the braking force is released. The operating status of Automatic brake hold can be displayed.

WARNING

- Automatic brake hold function is not designed to hold the vehicle on a steep hill or slippery road. Never use Automatic brake hold function when the vehicle is stopped on a steep hill or slippery road. Failure to do so may cause the vehicle to move.
- Warnings may appear to request that the driver retake control by depressing the brake pedal.
- When Automatic brake hold function is activated but fails to maintain the vehicle at a standstill, depress the brake pedal to stop the vehicle. If the vehicle unexpectedly moves due to outside conditions, the chime may sound and warnings may appear.
- Be sure to deactivate Automatic brake hold function when using a drive-thru car wash or towing your vehicle.
- Make sure the vehicle is in the P (Park) position and apply the electronic parking brake when parking your vehicle, riding on or off the vehicle, or loading or unloading luggage. Failure to do so could cause the

vehicle to move or roll away unexpectedly and result in serious personal injury or property damage.

- If any of the following conditions occur, Automatic brake hold function may not function. Have the system checked promptly. It is recommended that you visit a NISSAN dealer or qualified workshop for this service.
 - A warning message appears.
 - The indicator light on Automatic brake hold switch does not illuminate when the switch is pushed.

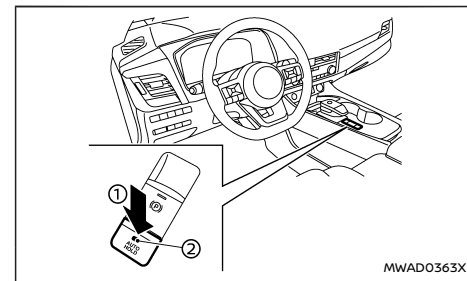
Failure to operate the vehicle in accordance with these conditions could cause the vehicle to move or roll away unexpectedly and result in serious personal injury or property damage.

- Automatic brake hold function will not be activated if the slip indicator light, electronic parking brake warning light, brake system warning light (yellow), or master battery system fault warning message appears.
- To maintain the braking force to keep the vehicle to a standstill, a noise may be heard. This is not a malfunction.
- Automatic brake hold function is operated by applying sufficient braking force to hold the vehicle in its place, so there are cases when this hold function is maintained even if the accelerator pedal is depressed. In

this situation, it is advised to depress the brake pedal first, then to turn off the Automatic brake hold switch. This will cancel the hold function.

HOW TO ACTIVATE/DEACTIVATE AUTOMATIC BRAKE HOLD FUNCTION

How to activate Automatic brake hold function



1. With the power switch in the ON position, push the automatic brake hold switch ①. The indicator light on Automatic brake hold switch ② illuminates.
2. When Automatic brake hold function goes into standby, Automatic brake hold indicator light (white) illuminates.

To use Automatic brake hold function, the following conditions need to be met.

- The driver's seat belt is fastened.

- The electronic parking brake is released.
- The vehicle is not in the P (Park) position.
- The vehicle is not parked on a steep hill.

NOTE:

Automatic brake hold function retains the last state until the driver changes the option even if the power switch is turned off.

How to deactivate Automatic brake hold function

While Automatic brake hold function is activated, push Automatic brake hold switch to turn off Automatic brake hold indicator light and deactivate Automatic brake hold function. To deactivate Automatic brake hold function while the braking force has been maintained by Automatic brake hold function, depress the brake pedal and push Automatic brake hold switch.

 **WARNING**

Make sure to firmly depress and hold the brake pedal when turning off Automatic brake hold function while the braking force is applied. When Automatic brake hold function is deactivated, the braking force will be released. This could cause the vehicle to move or roll away unexpectedly.

Failure to prevent the vehicle from rolling may result in serious personal injury or property damage.

HOW TO USE AUTOMATIC BRAKE HOLD FUNCTION**To maintain braking force automatically**

With Automatic brake hold function activated and Automatic brake hold indicator light (white) illuminated, depress the braking pedal to stop the vehicle, and the indicator light (green) illuminates. The braking force is automatically applied without your foot depressed on the brake pedal. While the braking force is maintained, Automatic brake hold indicator light (green) illuminates.

Automatic brake hold indicator light (green) will not illuminate if the brake pedal is not depressed with sufficient force to hold the vehicle or is released too quickly when the vehicle is stopped.

Confirm Automatic brake hold indicator light (green) is illuminated before removing your foot from the brake pedal.

To start the vehicle from a standstill

With the vehicle not in the P (Park) or the N (Neutral) position, the braking force will automatically be released to restart the vehicle. Automatic brake hold indicator light (white) illuminates and Automatic brake hold returns to standby.

Parking

When the vehicle is in the P (Park) position with the braking force maintained by Automatic brake hold function, the electronic parking brake will automatically be applied and the braking force of Automatic brake hold will be released. Automatic brake hold indicator light turns off. When the electronic parking brake is applied with the brak-

ing force maintained by Automatic brake hold function, the braking force of Automatic brake hold will be released. Automatic brake hold indicator light turns off.

NOTE:

- **Under the following conditions, the electronic parking brake will automatically be applied and the braking force of Automatic brake hold will be released. Automatic brake hold indicator light turns off.**
 - **The braking force is applied by Automatic brake hold function for 3 minutes or longer.**
 - **The vehicle is in the P (Park) position.**
 - **Electric parking brake is applied manually.**
 - **The driver's seat belt is unfastened.**
 - **The driver's door is opened.**
 - **The power switch is placed in the OFF position.**
 - **A malfunction occurs in Automatic brake hold function.**
- **When the vehicle stops, but the braking force is not automatically applied, depress the brake pedal firmly until Automatic brake hold indicator light (green) illuminates.**
- **When the vehicle stops on a slope, depress the brake pedal firmly until Automatic brake hold indicator light (green) illuminates.**

4 Monitor, heater, air conditioner, audio and phone systems

Apple CarPlay and Android Auto (where fitted)	194	How to switch the display	213
NISSANCONNECT (where fitted)	194	Adjusting the screen	213
SAFETY INFORMATION	195	Intelligent Around View Monitor system limitations	214
NAVIGATION (where fitted)	196	System maintenance	216
AUDIO OPERATION PRECAUTIONS	197	Moving Object Detection (MOD) (where fitted)	216
HOW TO UPDATE MAP DATA (where fitted)	197	MOD system operation	217
UPDATING SYSTEM SOFTWARE (where fitted)	197	Turning MOD on and off	218
REGULATORY INFORMATION	197	MOD system limitations	218
TRADEMARKS	199	System maintenance	219
LICENCES	199	Vents	219
Safety precautions	200	Centre vents	219
Rear view monitor (where fitted)	201	Side vents	219
Rear view monitor system operation	202	Rear vents	220
How to read the displayed lines	202	Heater and air conditioner	220
Difference between predictive and actual distances	202	Operating tips	220
How to park with predictive course lines	204	Automatic air conditioner (models with rear control)	221
Rear view monitor settings	205	Servicing air conditioner	223
Rear view monitor system limitations	205	Radio antenna	223
System maintenance	206	Car phone or CB radio	224
Intelligent Around View Monitor (where fitted)	207		
Intelligent Around View Monitor system operation	208		
Difference between predictive and actual distances	210		
How to park with predictive course lines	212		

Apple CarPlay AND Android Auto (where fitted)

WARNING

- **Stop your vehicle in a safe location and apply the parking brake before connecting your mobile device to the vehicle or operating your connected mobile device for setup.**
- **Laws in some jurisdictions may restrict the use of some of the applications and features, such as social networking and texting. Check local regulations for any requirements.**
- **If you are unable to devote full attention to vehicle operation while using your mobile device, pull off the road to a safe location and stop your vehicle.**

Apple CarPlay:

With Apple CarPlay, your in-vehicle system can be used as a display and a controller for some of the iPhone functions. Apple CarPlay features Siri which enables operations via voice controls. Wireless Apple CarPlay (where fitted) is also available for certain iPhone models. Refer to the NissanConnect Owner's Manual and visit the Apple website for information about the functions that are available and other details.

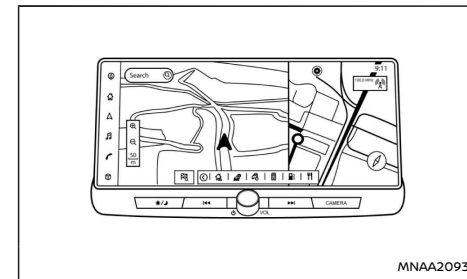
NOTE:

To ensure efficient wireless charging (where fitted) , do not use wireless Apple CarPlay and wireless charging simultaneously for long periods. Use a USB connection in these circumstances.

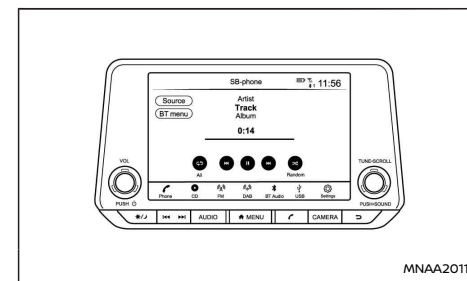
Android Auto:

With Android Auto, your in-vehicle system can be used as a display and a controller for some of your Android phone functions. Android Auto supports Talk to Google which enables operations via voice controls. Refer to the NissanConnect Owner's Manual and visit the Android Auto website for information about the functions that are available and other details.

NISSANCONNECT (where fitted)



Type A



Type B

For details, see the separately provided NissanConnect Owner's Manual.

- Online:
 - **TYPE A**
Go to: <https://uqr.to/1mwf8>
Or scan the QR code



WAE0858X

— TYPE B

Go to: <https://uqr.to/1mztd>
Or scan the QR code



WAE0858X

- Printed version: Please contact your NISSAN dealer or qualified workshop.

SAFETY INFORMATION

This system is primarily designed to help you support pleasant driving as outlined in this manual. However, you, the driver, must use the system safely and properly. Information and the availability of services may not always be up to date. The system is not a substitute for safe, proper and legal driving.

Before using the system, please read the following safety information. Always use the system as outlined in this manual.

WARNING

- To operate the system, first park the vehicle in a safe location and set the parking brake. Operating the system while driving can distract the driver and may result in a serious accident.
- Exercise extreme caution at all times so full attention may be given to vehicle operation. If the system does not respond immediately, please be patient and keep your eyes on the road. Inattentive driving may lead to a crash resulting in serious injuries or death.
- Do not rely on route guidance (where fitted) alone. Always be sure that all driving manoeuvres are legal and safe in order to avoid accidents.
- Do not disassemble or modify this system. If you do, it may result in accidents, fire or electrical shock.
- If you notice any foreign objects in the

system hardware, spill liquid on the system or notice smoke or a smell coming from it, stop using the system immediately and it is recommended you contact a NISSAN dealer or qualified workshop. Ignoring such conditions may lead to accidents, fire or electrical shock.

CAUTION

- Some jurisdictions may have laws limiting the use of video screens while driving. Use this system only where it is legal to do so.
- Extreme temperature conditions (below -20°C (-4°F) and above 70°C (158°F)) could affect the performance of the system.
- The display screen may break if it is hit with a hard or sharp object. If the display screen breaks, do not touch it. Doing so could result in an injury.

NOTE:

Do not keep the system running with the e-POWER system stopped. Doing so may discharge the vehicle battery (12V battery). When you use the system, always keep the e-POWER system running.

Models with NissanConnect Services:

NissanConnect Services may not be available in some regions. Completing the NissanConnect Services registration is necessary to use NissanConnect Services related functions.

Hands-free telephone control

WARNING

- Use a phone after stopping your vehicle in a safe location. If you have to use a phone while driving, exercise extreme caution at all times so full attention may be given to vehicle operation.
- If you find yourself unable to devote full attention to vehicle operation while talking on the phone, pull off the road to a safe location and stop your vehicle before doing so.

CAUTION

To avoid draining the vehicle battery (12V battery), use a phone only after starting the e-POWER system.

Hands-free text messaging assistant

WARNING

- Use the text messaging feature after parking your vehicle in a safe location. If you have to use the feature while driving, exercise extreme caution at all times so full attention may be given to vehicle operation.
- Laws in some jurisdictions may restrict the use of "Text-to-Speech." Check local regulations before using this feature.
- Laws in some jurisdictions may restrict the use of some of the applications and

features, such as social networking and texting. Check local regulations for any requirements.

- If you are unable to devote full attention to vehicle operation while using the text messaging feature, pull off the road to a safe location and stop your vehicle.

CAUTION

This feature is disabled if the connected device does not support it. See the phone's Owner's Manual for details and instructions.

Liquid crystal display

The display on this unit is a liquid crystal display and should be handled with care.

WARNING

Never disassemble the display. Some parts utilise extremely high voltage. Touching them may result in serious personal injury.

Maintenance of display:

To clean the display screen, use a dry, soft cloth. If additional cleaning is necessary, use a small amount of neutral detergent with a soft cloth. Never spray the screen with water or detergent. Dampen the cloth first, then wipe the screen.

CAUTION

- To clean the display, never use a rough cloth, alcohol, benzene, thinner or any kind of solvent or paper towel with a chemical

cleaning agent. They will scratch or deteriorate the panel.

- Do not splash any liquid, such as water or car fragrance, on the display. Contact with liquid will cause the system to malfunction.

NAVIGATION (where fitted)

The navigation system is primarily designed to help you reach your destination. However, you, the driver, must use the system safely and properly. Information concerning road conditions, traffic signs and the availability of services may not always be up to date. The system is not a substitute for safe, proper, and legal driving.

WARNING

- Do not rely on route guidance alone. Always be sure that all driving manoeuvres are legal and safe in order to avoid accidents.
- Always stop the vehicle in a safe location before modifying the route conditions. Modifying the route conditions while driving may cause an accident.
- The navigation system's visual and voice guidance is for reference purposes only. The contents of the guidance may be inappropriate depending on the situation.
- Follow all traffic regulations when driving along the suggested route (e.g. one-way traffic).

AUDIO OPERATION PRECAUTIONS

CAUTION

- Operate the audio system only when the e-POWER system is running. Operating the audio system for extended periods of time with the e-POWER system turned off can discharge the vehicle battery (12V battery).
- Do not allow the system to get wet. Excessive moisture such as spilled liquids may cause the system to malfunction.

HOW TO UPDATE MAP DATA (where fitted)

⚠ WARNING

TO AVOID RISK OF DEATH OR SERIOUS PERSONAL INJURY WHEN UPDATING THE MAP SOFTWARE:

If you choose to park the vehicle within range of a Wi-Fi connection (where fitted) or a TCU (Telematics Control Unit) (where fitted), park the vehicle in a secure, safe, well-ventilated location that is open to the air. During the update process, if you choose to park your vehicle, it should be kept in a well ventilated area to avoid exposure to carbon monoxide. Do not breathe exhaust gases; they contain colourless and odourless carbon monoxide. Carbon monoxide is dangerous. It can cause unconsciousness or death.

UPDATING SYSTEM SOFTWARE (where fitted)

⚠ WARNING

TO AVOID RISK OF DEATH OR SERIOUS PERSONAL INJURY WHEN UPDATING THE SYSTEM SOFTWARE:

If you choose to park the vehicle within range of a Wi-Fi connection (where fitted), park the vehicle in a secure, safe, well-ventilated location that is open to the air. During the update process, if you choose to park your vehicle, it should be kept in a well ventilated area to avoid exposure to carbon monoxide. Do not breathe exhaust gases; they contain colourless and odourless carbon monoxide. Carbon monoxide is dangerous. It can cause unconsciousness or death.

How to update from the system menu

⚠ WARNING

To operate the system for software update, first park the vehicle in a safe location.

REGULATORY INFORMATION

Radio approval number and information

For Europe:**Type A:**

Hereby, Robert Bosch GmbH declares that the radio equipment type AIV12SBXM is in compliance with Directive 2014/53/EU.

The full text of the EU declaration of conformity is available at the following internet address:

<https://eu-doc.bosch.com>



Hereby, Robert Bosch GmbH declares that the radio equipment type AIV12SBXM is in compliance with of Radio Equipment Regulations 2017.

**Frequency Band**

2400 MHz - 2480 MHz

5490 MHz - 5600 MHz

5650 MHz - 5710 MHz ≤ 100 mW

5735 MHz - 5835 MHz ≤ 25 mW

Radiated Power (EIRP)

Bluetooth < 10 mW

WLAN < 100 mW

Hints/Restrictions

Internal Antenna

Internal antenna not accessible by user. Any change by the user will violate the legal approval of this product.

Type B:

Hereby, Robert Bosch GmbH declares that the

radio equipment type AIVIP33A0 is in compliance with Directive 2014/53/EU.

The full text of the EU declaration of conformity is available at the following internet address:

<https://eu-doc.bosch.com>



Hereby, Robert Bosch GmbH declares that the radio equipment type AIVIP33A0 is in compliance with of Radio Equipment Regulations 2017.



Frequency Band

2400 MHz - 2480 MHz

Radiated Power (EIRP)

Bluetooth < 10 mW

WLAN < 100 mW

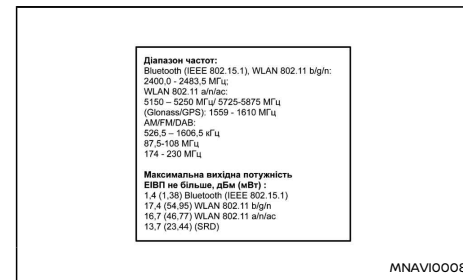
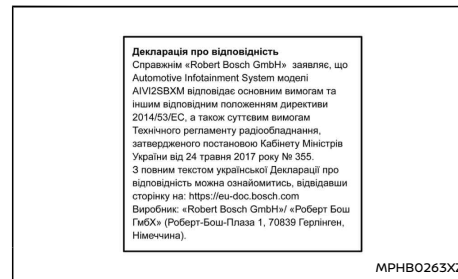
Hints/Restrictions

Internal Antenna

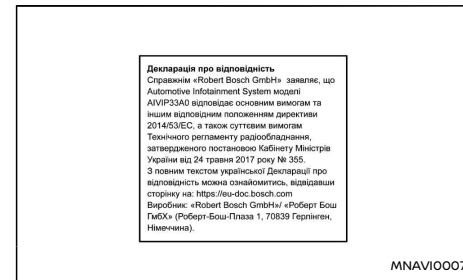
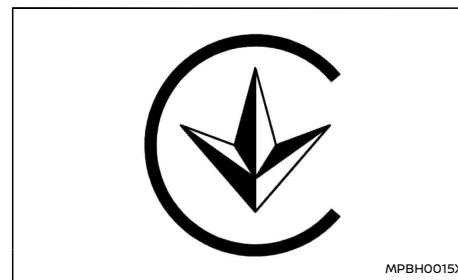
Internal antenna not accessible by user. Any change by the user will violate the legal approval of this product.

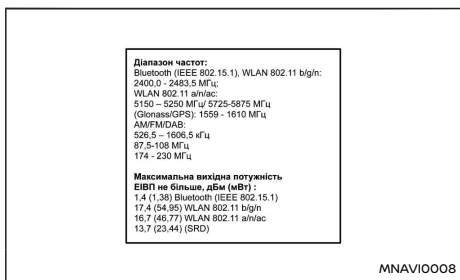
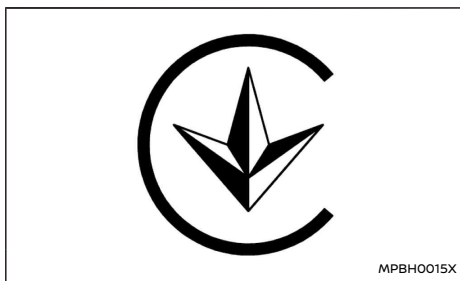
For Ukraine:

Type A:



Type B:





TRADEMARKS



Apple, iPhone, iPod, and iPod touch are trademarks of Apple Inc., registered in the U.S. and other countries. Apple CarPlay is a trademark of Apple Inc. Use of the Apple CarPlay logo means that a vehicle user interface meets Apple performance standards. Apple is not responsible for the operation of this vehicle or its compliance with safety and regulatory standards. Please note that the use of this product with iPhone or iPod may affect wireless performance.



Music recognition technology and related data are provided by Gracenote®. Gracenote is the industry standard in music recognition technology and

related content delivery. For more information, visit www.gracenote.com. Music related data from Gracenote, Inc., copyright © 2000 to present Gracenote. Gracenote Software, copyright © 2000 to present Gracenote.

One or more patents owned by Gracenote apply to this product and service. See the Gracenote website for a nonexhaustive list of applicable Gracenote patents. Gracenote, the Gracenote logo and logotype are either a registered trademark or a trademark of Gracenote, Inc. in the United States and/or other countries.

App Store

Apple and the Apple logo are trademarks of Apple Inc., registered in the U.S. and other countries. App Store is a service mark of Apple Inc.

Siri

Siri is a trademark of Apple Inc., registered in the U.S. and other countries.

Google/Android/Google Play/Android Auto

Google, Android, Google Play, Android Auto, and other marks are trademarks of Google LLC.

LICENCES

SOFTWARE LICENCES

Open Source Software Licences

<http://oss.bosch-cm.com/nissan.html>

SAFETY PRECAUTIONS

Telematics Control unit (TCU) (where fitted)

<http://opensourceautomotive.com/IC/tZ7T3eE6AiV4>

or

<https://www.oss-valeo.com/nissan/default.html>

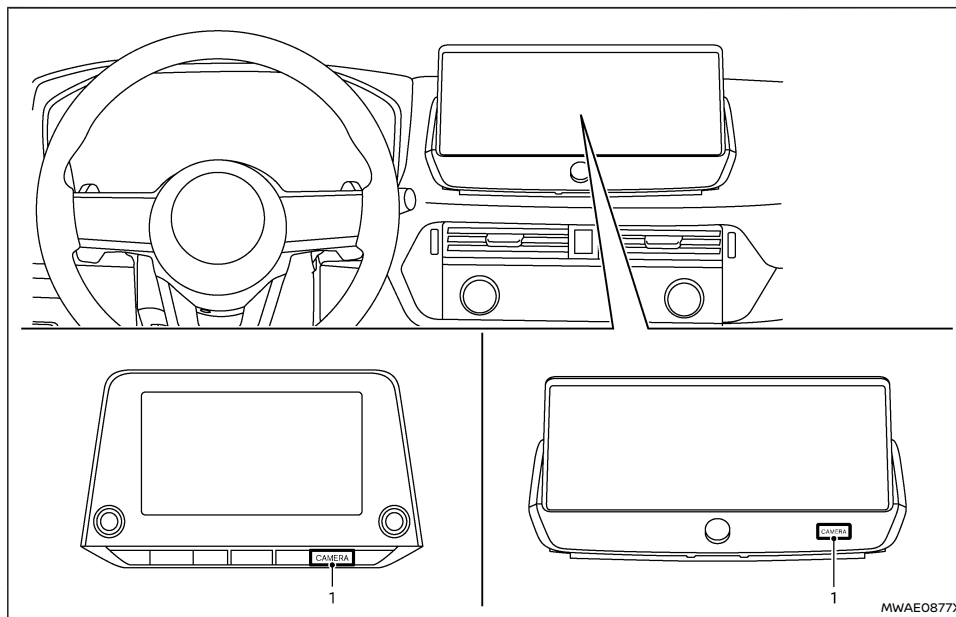
WARNING

- Do not adjust the display controls, heater and air conditioner controls or audio controls while driving so that full attention may be given to vehicle operation.
- If you noticed any foreign objects entering the system hardware, spilled liquid on the system, or noticed smoke or fumes coming out from the system, or any other unusual operation is observed, stop using the system immediately and contact the nearest NISSAN dealer or qualified workshop. Ignoring such conditions may lead to an accident, fire or electric shock.
- Do not disassemble or modify this system. If you do, it may lead to an accident, fire, or electric shock.
- Park the vehicle in a safe location and apply the parking brake to view images on the front centre display screen.

CAUTION

Do not use the system when the e-POWER system is not running for extended periods of time to prevent 12-volt battery discharge.

REAR VIEW MONITOR (where fitted)



1. <CAMERA> button

⚠ WARNING

- Failure to follow the warnings and instructions for proper use of the rear view monitor could result in serious injury or death.
- The rear view monitor is a convenience

feature and is not a substitute for proper reversing. Always turn and look out the windows, and check mirrors to be sure that it is safe to move before operating the vehicle. Always reverse slowly.

- The system is designed as an aid to the driver in showing large stationary objects

directly behind the vehicle, to help avoid damaging the vehicle.

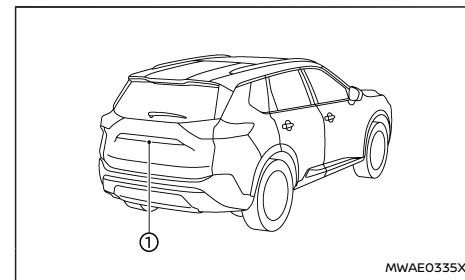
- The distance guide line and the vehicle width line should be used as a reference only when the vehicle is on a level paved surface. The distance viewed on the monitor is for reference only and may be different than the actual distance between the vehicle and displayed objects.

CAUTION

There is a transparent cover over the camera lens. Do not scratch the cover when cleaning dirt or snow from it.

The rear view monitor system automatically shows a rear view of the vehicle when the shift lever is placed in the R (Reverse) position.

The radio can still be heard while the rear view monitor is active.

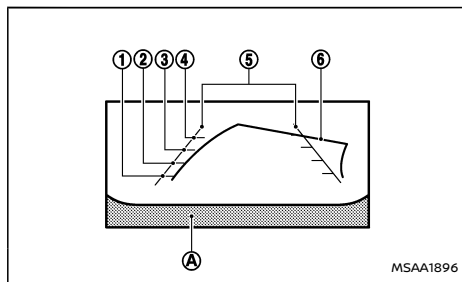


To display the rear view, the rear view monitor system uses a camera ① located just above the vehicle's number plate.

REAR VIEW MONITOR SYSTEM OPERATION

When the power switch is placed in the ON position, move the shift lever to the R (Reverse) position to operate the rear view monitor.

HOW TO READ THE DISPLAYED LINES



Guiding lines which indicate the vehicle width and distances to objects with reference to the bumper line ① are displayed on the monitor.

Distance guide lines:

Indicate distances from the vehicle body.

- Red line ①: approximately 0.5 m (1.5 ft)
- Yellow line ②: approximately 1 m (3 ft)
- Green line ③: approximately 2 m (7 ft)
- Green line ④: approximately 3 m (10 ft)

Vehicle width guide lines ⑤:

Indicate the vehicle width when reversing.

Predictive course lines ⑥:

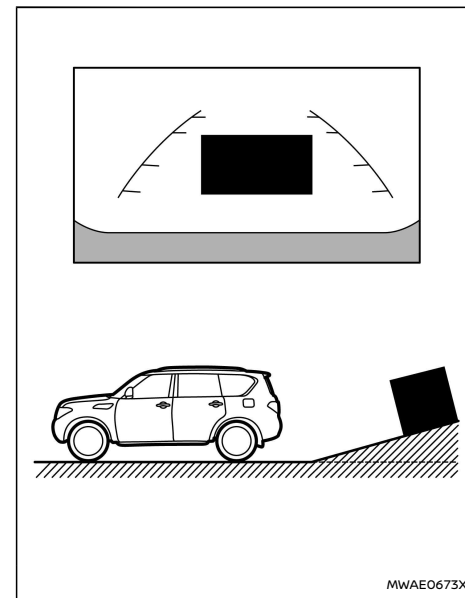
Indicate the predictive course when reversing. The predictive course lines will be displayed on the monitor when the shift lever is in the R (Reverse) position and if the steering wheel is turned. The predictive course lines will move depending on how much the steering wheel is turned and will not be displayed while the steering wheel is in the straight ahead position.

The vehicle width guide lines and the width of the predictive course lines are wider than the actual width and course.

DIFFERENCE BETWEEN PREDICTIVE AND ACTUAL DISTANCES

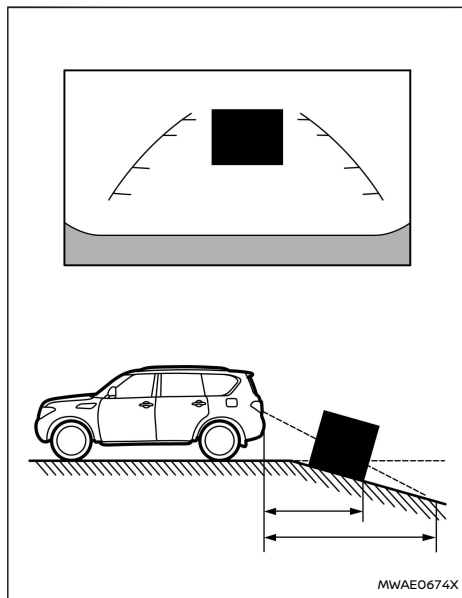
The displayed guide lines and their locations on the ground are for approximate reference only. Objects on uphill or downhill surfaces or projecting objects will be actually located at distances different from those displayed in the monitor relative to the guide lines (refer to illustrations). When in doubt, turn around and view the objects as you are reversing, or park and exit the vehicle to view the positioning of objects behind the vehicle.

Reversing on a steep uphill



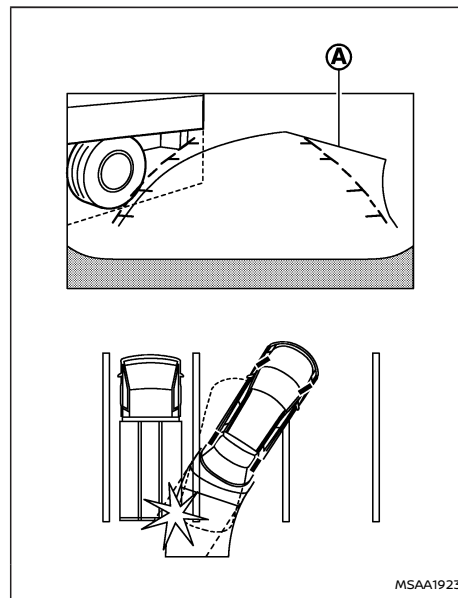
When reversing the vehicle up a hill, the distance guide lines and the vehicle width guide lines are shown closer than the actual distance. Note that any object on the hill is farther than it appears on the monitor.

Reversing on a steep downhill



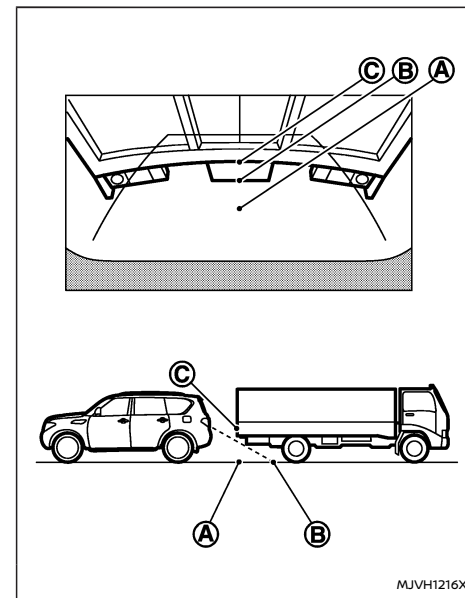
When reversing the vehicle down a hill, the distance guide lines and the vehicle width guide lines are shown farther than the actual distance. Note that any object on the hill is closer than it appears on the monitor.

Reversing near a projecting object



The predictive course lines ① do not touch the object in the display. However, the vehicle may hit the object if it projects over the actual reversing course.

Reversing behind a projecting object

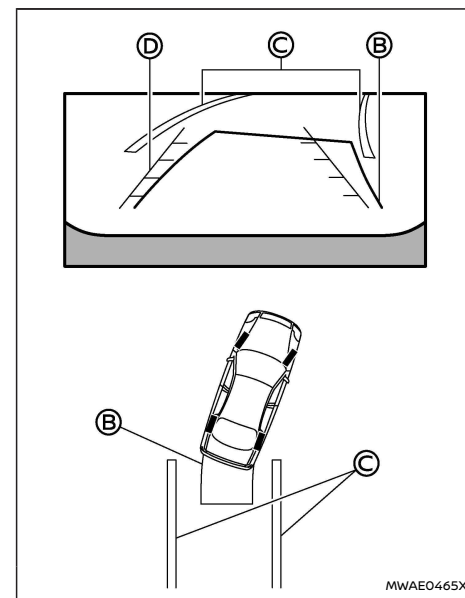
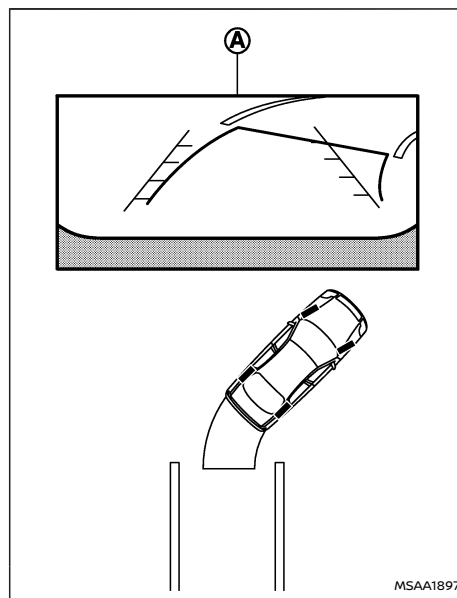


The position ③ is shown farther than the position ② in the display. However, the position ③ is actually at the same distance as the position ①. The vehicle may hit the object when reversing to the position ① if the object projects over the actual reversing course.

HOW TO PARK WITH PREDICTIVE COURSE LINES

⚠ WARNING

- If the tyres are replaced with different sized tyres, the predictive course lines may be displayed incorrectly.
- On a snow-covered or slippery road, there may be a difference between the predictive course line and the actual course line.
- If the 12-volt battery is disconnected or becomes discharged, the predictive course lines may be displayed incorrectly. If this occurs, please perform the following procedures:
 - Turn the steering wheel from lock to lock while the e-POWER system is running.
 - Drive the vehicle on a straight road for more than 5 minutes.
- When the steering wheel is turned with the power switch in the ON position, the predictive course lines may be displayed incorrectly.



1. Visually check that the parking space is safe before parking your vehicle.
2. The rear view of the vehicle is displayed on the screen (A) when the shift lever is moved to the R (Reverse) position.
3. Slowly reverse the vehicle adjusting the steering wheel so that the predictive course lines (B) enter the parking space (C).
4. Manoeuvre the steering wheel to make the vehicle width guide lines (D) parallel to the parking space (C) while referring to the predictive course lines.

5. When the vehicle is parked in the space completely, place the shift position in the P (Park) position and apply the parking brake.

REAR VIEW MONITOR SETTINGS

To set up the rear view monitor, push the <CAMERA> button while the shift lever is out of the R (Reverse) position to display the Camera Setting screen.

Available setting items:

- Predictive course line
Predictive course lines can be turned on/off.
- Display setting
The brightness, contrast, tint, colour and black level can be adjusted.

NOTE:

Do not adjust any of the display settings of the rear view monitor while the vehicle is moving. Make sure the parking brake is firmly applied.

The predictive course lines can also be turned on and off by pushing the <CAMERA> button while the shift lever is in the R (Reverse) position.

REAR VIEW MONITOR SYSTEM LIMITATIONS

WARNING

Listed below are the system limitations for the rear view monitor. Failure to operate the vehicle in accordance with these system limitations could result in serious injury or death.

- The system cannot completely eliminate blind spots and may not show every object.

- **Underneath the bumper and the corner areas of the bumper cannot be viewed on the rear view monitor because of its monitoring range limitation. The system will not show small objects below the bumper, and may not show objects close to the bumper or on the ground.**
- **Objects viewed in the rear view monitor differ from actual distance because a wide-angle lens is used.**
- **Objects in the rear view monitor will appear visually opposite compared to when viewed in the rear view and outside rearview mirrors.**
- **Use the displayed lines as a reference. The lines are highly affected by the number of occupants, fuel level, vehicle position, road conditions and road grade.**
- **Make sure that the back door is securely closed when reversing.**
- **Do not put anything on the rear view camera. The rear view camera is installed above the number plate.**
- **When washing the vehicle with high-pressure water, be sure not to spray it around the camera. Otherwise, water may enter the camera unit causing water condensation on the lens, a malfunction, fire or an electric shock.**
- **Do not strike the camera. It is a precision instrument. Otherwise, it may malfunction or cause damage resulting in a fire or an electric shock.**

The following are operating limitations and do not represent a system malfunction:

- When the temperature is extremely high or low, the screen may not clearly display objects.
- When strong light directly shines on the camera, objects may not be displayed clearly.
- Vertical lines may be seen in objects on the screen. This is due to strong reflected light from the bumper.
- The screen may flicker under fluorescent light.
- The colours of objects on the rear view monitor may differ somewhat from the actual colour of objects.
- Objects on the monitor may not be clear in a dark environment.
- There may be a delay when switching between views.
- If dirt, rain or snow accumulates on the camera, the rear view monitor may not display objects clearly. Clean the camera.
- Do not use wax on the camera lens. Wipe off any wax with a clean cloth dampened with a diluted mild cleaning agent, then wipe with a dry cloth.

If the camera image is not displayed properly

If the following condition persists even with the shift position switched to R (Reverse) and the rear view monitor system activated, the camera system may be malfunctioning. This will not hinder normal driving operation, but the system should be inspected. It is recommended you visit a NISSAN dealer or qualified workshop.

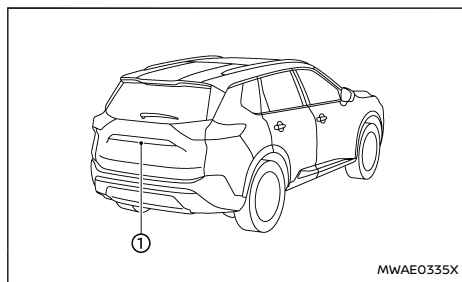
If the camera system does not work:

When the screen does not switch to the camera image and continues to display the previous screen (other than the camera).

If there is an abnormality in the image (due to camera system malfunction):

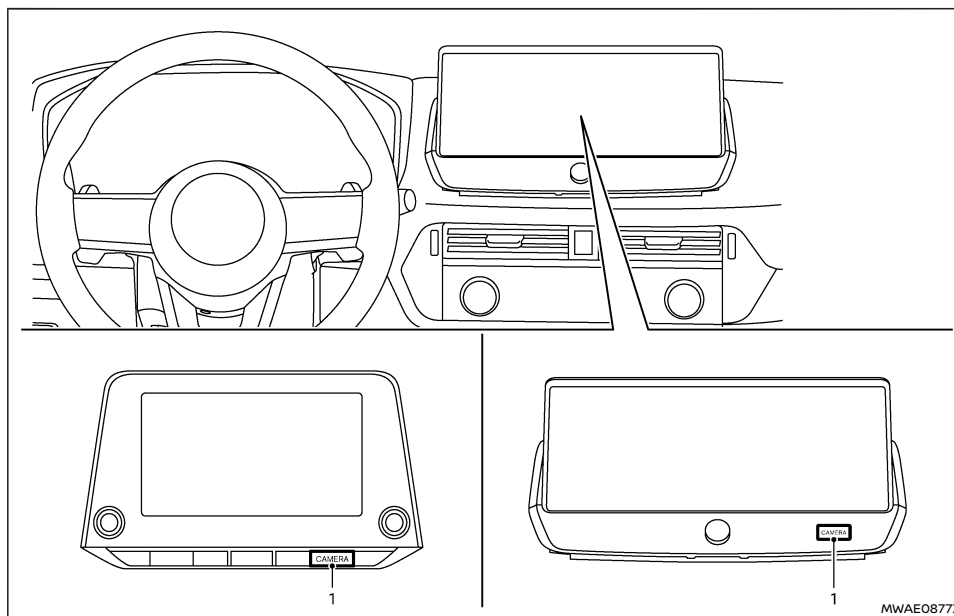
When the rear view monitor screen displays abnormal camera images such as black, blue or grey, etc.

If dirt, rain or snow accumulates on the camera ①, rear view monitor may not display objects clearly. Clean the camera by wiping it with a cloth dampened with a diluted mild cleaning agent and then wiping it with a dry cloth.

SYSTEM MAINTENANCE**CAUTION**

- Do not use alcohol, benzine or thinner to clean the camera. This will cause discoloration.
- Do not damage the camera as the monitor screen may be adversely affected.

INTELLIGENT AROUND VIEW MONITOR (where fitted)



1. <CAMERA> button

⚠ WARNING

- Failure to follow the warnings and instructions for the proper use of the Intelligent Around View Monitor system could result in serious injury or death.
- The Intelligent Around View Monitor is a

convenience feature and is not a substitute for proper vehicle operation because it has areas where objects cannot be viewed. The four corners of the vehicle in particular, are areas where objects do not always appear in the bird's-eye, front, or rear views. Always check your surroundings to be sure that it is safe to move

before operating the vehicle. Always operate the vehicle slowly.

- The driver is always responsible for safety during parking and other manoeuvres.

CAUTION

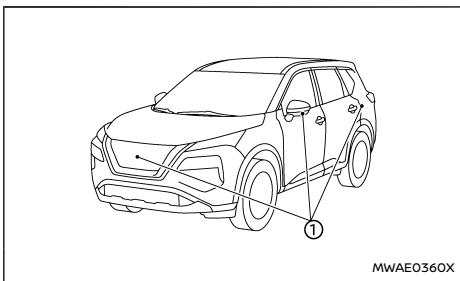
Do not scratch the lens when cleaning dirt or snow from the front of the camera.

The Intelligent Around View Monitor system is designed as an aid to the driver in situations such as slot parking or parallel parking.

The monitor displays various views of the position of the vehicle in a split screen format. Not all views are available at all times.

Available views:

- Front view
A view of the front of the vehicle
- Rear view
A view of the rear of the vehicle
- Bird's-eye view
The surrounding view of the vehicle from above
- Front-side view
The view around and ahead of the front passenger's side wheel
- Front-wide view
A wider area view of the front view
- Rear-wide view
A wider area view of the rear view



To display the multiple views, the Intelligent Around View Monitor system uses cameras ① located on the front grille, on the vehicle's outside rearview mirrors and one just above the vehicle's rear number plate.

INTELLIGENT AROUND VIEW MONITOR SYSTEM OPERATION

When the power switch is placed in the ON position, push the **<CAMERA>** button on the instrument panel or move the shift lever to the R (Reverse) position to operate the Intelligent Around View Monitor.

The screen displayed on the Intelligent Around View Monitor will automatically return to the previous screen 3 minutes after the **<CAMERA>** button has been pushed with the shift lever in a position other than the R (Reverse) position.

Available views

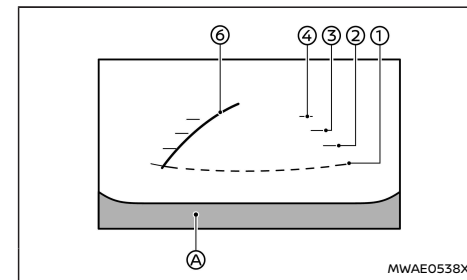
⚠ WARNING

- The distance guide lines and the vehicle width guide lines should be used as a reference only when the vehicle is on a paved, level surface. The apparent distance viewed on the monitor may be different than the actual distance between the vehicle and displayed objects.
- Use the displayed lines and the bird's-eye view as a reference. The lines and the bird's-eye view are greatly affected by the number of occupants, fuel level, vehicle position, road condition and road grade.
- If the tyres are replaced with different sized tyres, the predictive course lines and the bird's-eye view may be displayed incorrectly.
- When driving the vehicle up a hill, objects viewed in the monitor are farther than they appear. When driving the vehicle down a hill, objects viewed in the monitor are closer than they appear.
- Objects in the rear view will appear visually opposite compared to when viewed in the rear view and outside rearview mirrors.
- Use the mirrors or actually look to properly judge distances to other objects.
- The distance between objects viewed in the rear view differs from actual distance because a wide-angle lens is used.
- On a snow-covered or slippery road, there

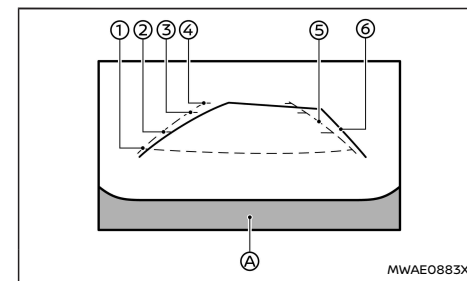
may be a difference between the predictive course line and the actual course line.

- The vehicle width and predictive course lines are wider than the actual width and course.

Front and rear view:



Front view



Rear view (example)

Guiding lines that indicate the approximate vehicle

width and distances to objects with reference to the vehicle body line (A), are displayed on the monitor.

Distance guide lines:

Indicate distances from the vehicle body.

- Red line ① : approximately 0.5 m (1.5 ft)
- Yellow line ② : approximately 1 m (3 ft)
- Green line ③ : approximately 2 m (7 ft)
- Green line ④ : approximately 3 m (10 ft)

Vehicle width guide lines ⑤ :

Indicate the vehicle width.

Predictive course lines ⑥ :

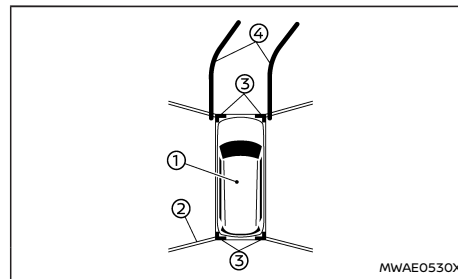
Indicate the predictive course when operating the vehicle. The predictive course lines will move depending on how much the steering wheel is turned. The predictive course lines in the rear view will not be displayed while the steering wheel is in the straight ahead position.

The front view will not be displayed when the vehicle speed is above 10 km/h (6 MPH).

NOTE:

When the monitor displays the front view and the steering wheel turns about 90 degrees or less from the straight ahead position, both the right and left predictive course lines ⑥ are displayed. When the steering wheel turns about 90 degrees or more, the predictive course line is displayed only on the opposite side of the turn.

Bird's-eye view:



The bird's-eye view shows the overhead view of the vehicle which helps confirm the vehicle position and the predictive course to a parking space.

The vehicle icon ① shows the position of the vehicle. Note that the distance between objects viewed in the bird's-eye view differs from the actual distance.

The areas between the camera views ② (where fitted) are indicated in black.

After the power switch is placed in the ON position, the non-viewable area ② (where fitted) is highlighted in yellow for a few seconds after the bird's-eye view is displayed.

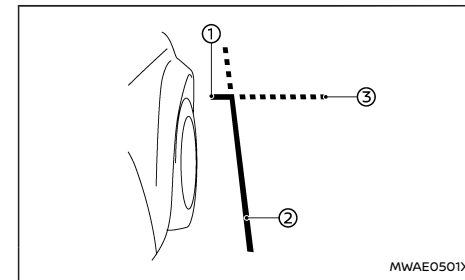
The amber markers ③ are displayed when the parking sensor (sonar) is turned off or the parking sensor (sonar) is not available at the corner.

The predictive course lines ④ indicate the predicted course when operating the vehicle.

⚠ WARNING

- Objects in the bird's-eye view will appear farther than the actual distance.
- Tall objects, such as a kerb or vehicle, may be misaligned or not displayed at the seam of the views.
- Objects that are above the camera cannot be displayed.
- The view for the bird's-eye view may be misaligned when the camera position alters.
- A line on the ground may be misaligned and is not seen as being straight at the seam of the views. The misalignment will increase as the line proceeds away from the vehicle.

Front-side view:



The screen layout in the illustration is for the Left-Hand Drive (LHD) model. For the Right-Hand Drive (RHD) model, the screen layout will be opposite.

Guiding lines:

Guiding lines that indicate the approximate width and the front end of the vehicle are displayed on the monitor.

The front-of-vehicle line ① shows the front part of the vehicle.

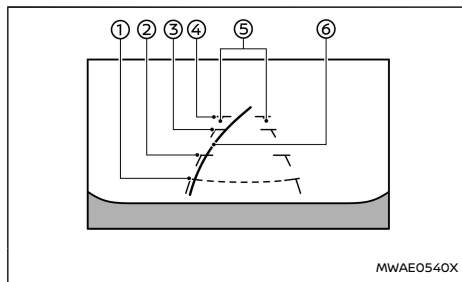
The side-of-vehicle line ② shows the vehicle width including the outside rearview mirrors.

The extensions ③ of both the front ① and side ② lines are shown with a green dotted line.

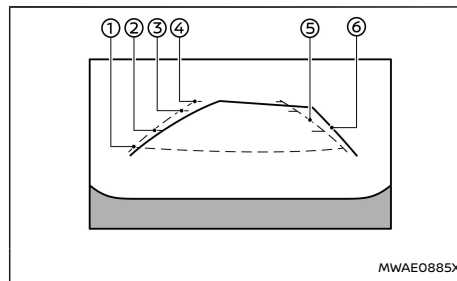
CAUTION

The turn signal light may look like the side-of-vehicle line. This is not a malfunction.

Front-wide/rear-wide view:



Front-wide view



Rear-wide view

While the front view/rear view shows a normal view on the split screens, the front-wide view/rear-wide view shows a wider area on the entire screen and allows checking of the blind corners on the right and left sides.

Distance guide lines ① - ④ :

Indicate distances from the vehicle body.

- Red line ① : approximately 0.5 m (1.5 ft)
- Yellow line ② : approximately 1 m (3 ft)
- Green line ③ : approximately 2 m (7 ft)
- Green line ④ : approximately 3 m (10 ft)

Vehicle width guide lines ⑤ :

Indicate the approximate vehicle width.

Predictive course lines ⑥ :

Indicate the predictive course when operating the vehicle. The predictive course lines will move depending on how much the steering wheel is turned. The predictive course lines in the rear-wide view will not be displayed while the steering wheel is in the straight ahead position.

The front-wide view will not be displayed when the vehicle speed is above 10 km/h (6 MPH).

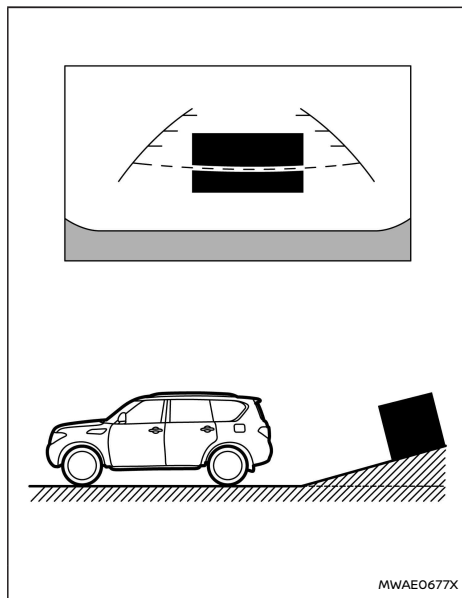
NOTE:

When the monitor displays the front-wide view and the steering wheel turns about 90 degrees or less from the straight ahead position, both the right and left predictive course lines ⑥ are displayed. When the steering wheel turns about 90 degrees or more, the predictive course line is displayed only on the opposite side of the turn.

DIFFERENCE BETWEEN PREDICTIVE AND ACTUAL DISTANCES

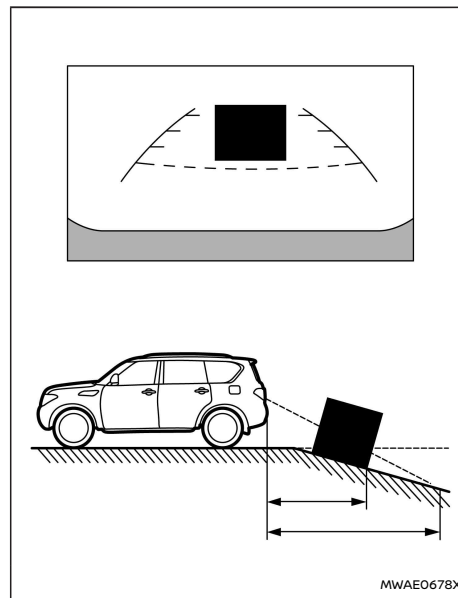
The displayed guide lines and their locations on the ground are for approximate reference only. Objects on uphill or downhill surfaces or projecting objects will be actually located at distances different from those displayed in the monitor relative to the guide lines (refer to illustrations). When in doubt, turn around and view the objects as you are reversing, or park and exit the vehicle to view the positioning of objects behind the vehicle.

Reversing on a steep uphill



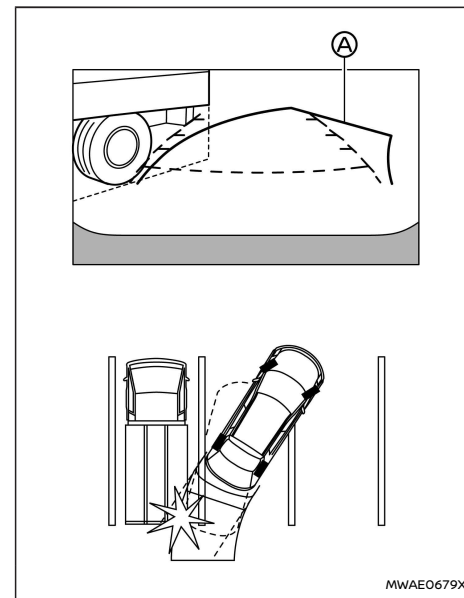
When reversing the vehicle up a hill, the distance guide lines and the vehicle width guide lines are shown closer than the actual distance. Note that any object on the hill is farther than it appears on the monitor.

Reversing on a steep downhill



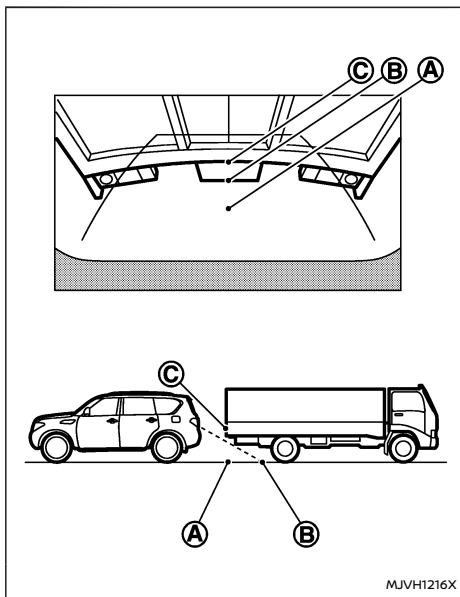
When reversing the vehicle down a hill, the distance guide lines and the vehicle width guide lines are shown farther than the actual distance. Note that any object on the hill is closer than it appears on the monitor.

Reversing near a projecting object



The predictive course lines (A) do not touch the object in the display. However, the vehicle may hit the object if it projects over the actual reversing course.

Reversing behind a projecting object

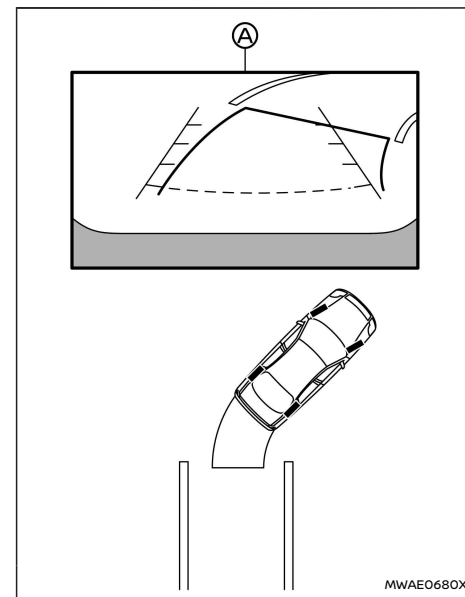


The position ③ is shown farther than the position ② in the display. However, the position ③ is actually at the same distance as the position ①. The vehicle may hit the object when reversing to the position ① if the object projects over the actual moving course.

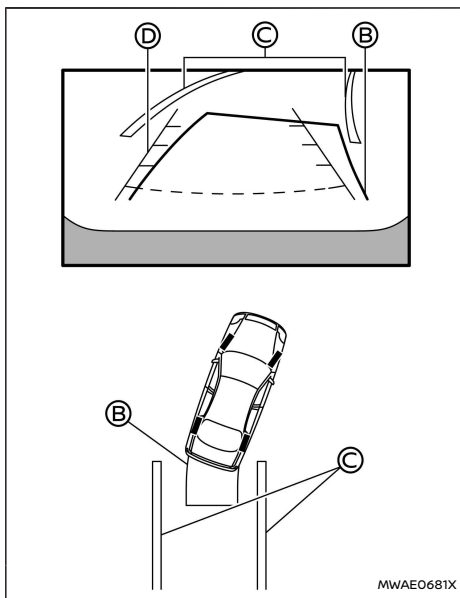
HOW TO PARK WITH PREDICTIVE COURSE LINES

⚠ WARNING

- If the tyres are replaced with different sized tyres, the predictive course lines may be displayed incorrectly.
- On a snow-covered or slippery road, there may be a difference between the predictive course line and the actual course line.
- If the 12-volt battery is disconnected or becomes discharged, the predictive course lines may be displayed incorrectly. If this occurs, please perform the following procedures:
 - Turn the steering wheel from lock to lock while the e-POWER system is running.
 - Drive the vehicle on a straight road for more than 5 minutes.
- When the steering wheel is turned with the power switch in the ON position, the predictive course lines may be displayed incorrectly.



1. Visually check that the parking space is safe before parking your vehicle.
2. The rear view of the vehicle is displayed on the screen ① when the shift lever is moved to the R (Reverse) position.



3. Slowly reverse the vehicle adjusting the steering wheel so that the predictive course lines ② enter the parking space ③.
4. Manoeuvre the steering wheel to make the vehicle width guide lines ④ parallel to the parking space ③ while referring to the predictive course lines.

5. When the vehicle is parked in the space completely, place the shift position in the P (Park) position and apply the parking brake.

HOW TO SWITCH THE DISPLAY

With the power switch placed in the ON position, push the **<CAMERA>** button or move the shift lever to the R (Reverse) position to operate the Intelligent Around View Monitor.

The Intelligent Around View Monitor displays different split screen views depending on the position of the shift lever. Push the **<CAMERA>** button to switch between the available views.

If the shift lever is in the R (Reverse) position, the available views are:

- Rear view/bird's-eye view split screen
- Rear view/front-side view split screen
- Rear-wide view

If the shift lever is out of the R (Reverse) position, the available views are:

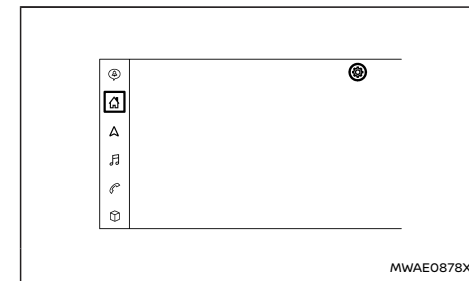
- Front view/bird's-eye view split screen
- Front view/front-side view split screen
- Front-wide view

The display will switch from the Intelligent Around View Monitor screen when:

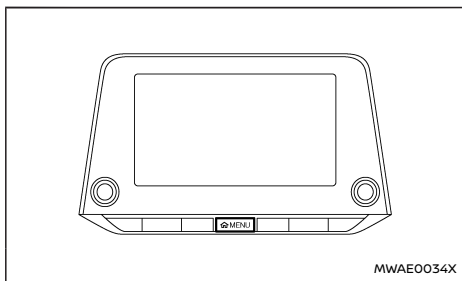
- The shift lever is in the D (Drive) position and the vehicle speed increases above approximately 10 km/h (6 MPH).
- A different screen is selected.

ADJUSTING THE SCREEN

Type A:



1. Touch the "Home" key.
2. Touch the "Settings" key.
3. Touch the [Camera] key.
4. Touch the [Display Settings] key.
5. Touch the "+" or "-" key of the desired item on the touch screen display. You can change the brightness, contrast, tint, colour and black level.

Type B:

MWAE0034X

1. Push the **<MENU>** button.
2. Touch the [Settings] key and then touch the [Camera] key.
3. Touch the [Display Setting] key.
4. Touch the [Brightness], [Contrast], [Tint], [Colour], or [Black Level] key.
5. Adjust the item by touching the "+" or "-" key on the touch screen display.

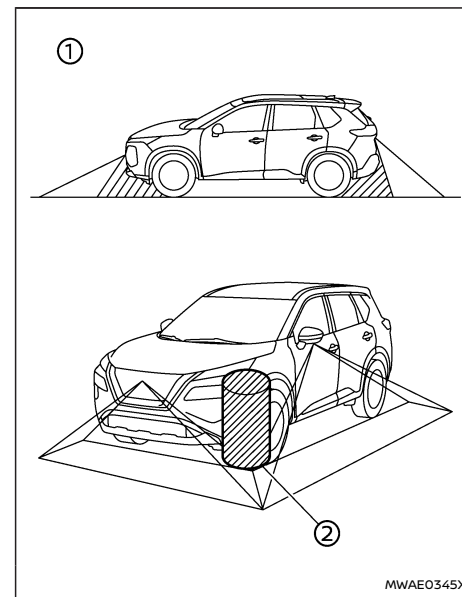
NOTE:

Do not adjust any of the Intelligent Around View Monitor settings while the vehicle is moving. Make sure the parking brake is firmly applied.

INTELLIGENT AROUND VIEW MONITOR SYSTEM LIMITATIONS**⚠ WARNING**

Listed below are the system limitations for the Intelligent Around View Monitor. Failure to operate the vehicle in accordance with these system limitations could result in serious injury or death.

- Do not use the Intelligent Around View Monitor with the outside rearview mirrors in the stored position, and make sure that the back door is securely closed when operating the vehicle using the Intelligent Around View Monitor.
- The apparent distance between objects viewed on the Intelligent Around View Monitor differs from the actual distance.
- The cameras are installed on the front grille, the outside rearview mirrors and above the rear number plate. Do not put anything on the cameras.
- When washing the vehicle with high pressure water, be sure not to spray it around the cameras. Otherwise, water may enter the camera unit causing water condensation on the lens, a malfunction, fire or an electric shock.
- Do not strike the cameras. They are precision instruments. Doing so could cause a malfunction or cause damage resulting in a fire or an electric shock.



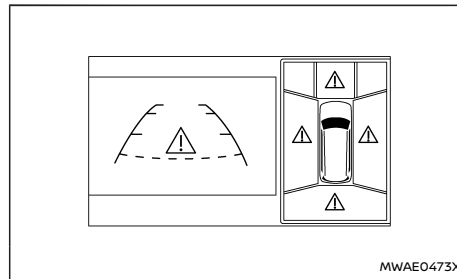
MWAE0345X

There are some areas where the system will not show objects and the system does not warn of moving objects. When in the front or the rear view display, an object below the bumper or on the ground may not be viewed ①. When in the bird's-eye view, a tall object near the seam ② of the camera viewing areas will not appear in the monitor.

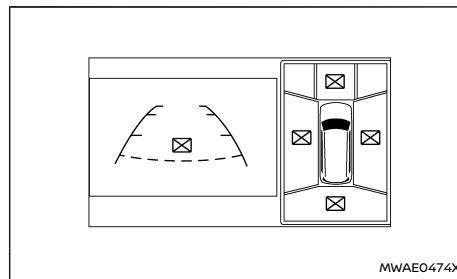
The following are operating limitations and do not represent a system malfunction:

- There may be a delay when switching between views.
- When the temperature is extremely high or low, the screen may not display objects clearly.
- When strong light directly shines on the camera, objects may not be displayed clearly.
- The screen may flicker under fluorescent light.
- The colours of objects on the Intelligent Around View Monitor may differ somewhat from the actual colour of objects.
- Objects on the Intelligent Around View Monitor may not be clear and the colour of the object may differ in a dark environment.
- There may be differences in sharpness between each camera view of the bird's-eye view.
- Do not use wax on the camera lens. Wipe off any wax with a clean cloth that has been dampened with a diluted mild cleaning agent, then wipe with a dry cloth.

System temporarily unavailable



When the "▲" icon is displayed on the screen, there will be abnormal conditions in the Intelligent Around View Monitor. This will not hinder normal driving operation but the system should be inspected. It is recommended you visit a NISSAN dealer or qualified workshop.



When the "☒" icon is displayed on the screen, the camera image may be receiving temporary electronic disturbances from surrounding devices. This will not hinder normal driving operation but the system should be inspected. It is recommended you visit a NISSAN dealer or qualified workshop.

The screen layout in the illustration is for the Left-Hand Drive (LHD) model. For the Right-Hand Drive (RHD) model, the screen layout will be opposite.

If the camera image is not displayed properly

If the following condition persists even with the shift position switched to R (Reverse) and the Intelligent Around View Monitor system activated, the camera system may be malfunctioning. This will not hinder normal driving operation, but the system should be inspected. It is recommended you visit a NISSAN dealer or qualified workshop.

If the camera system does not work:

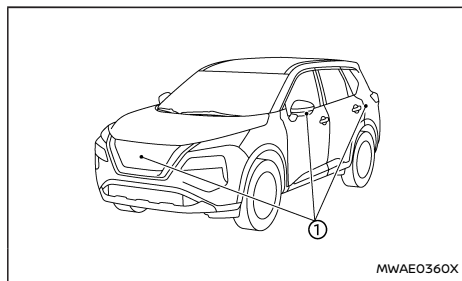
When the screen does not switch to the camera image and continues to display the previous screen (other than the camera).

If there is an abnormality in the image (due to camera system malfunction):

When the Intelligent Around View Monitor screen displays abnormal camera images such as black, blue or grey, etc.

MOVING OBJECT DETECTION (MOD) (where fitted)

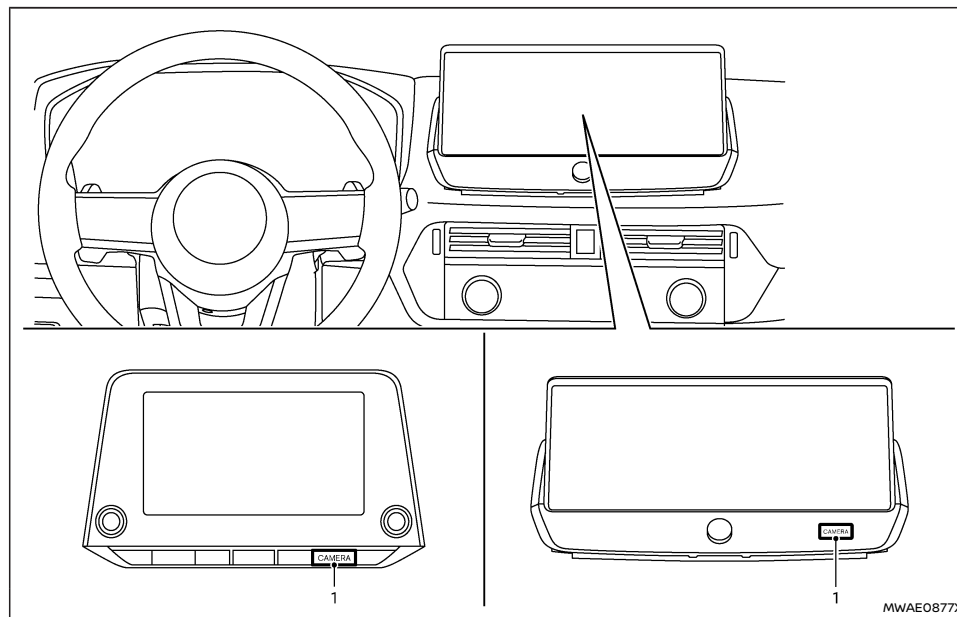
SYSTEM MAINTENANCE



CAUTION

- Do not use alcohol, benzine or thinner to clean the camera. This will cause discoloration.
- Do not damage the camera as the monitor screen may be adversely affected.

If dirt, rain or snow accumulates on any of the cameras ①, the Intelligent Around View Monitor may not display objects clearly. Clean the camera by wiping with a cloth dampened with a diluted mild cleaning agent and then wiping with a dry cloth.



1. <CAMERA> button

⚠ WARNING

- Failure to follow the warnings and instructions for proper use of the Moving Object Detection system could result in serious injury or death.
- The MOD system is not a substitute for

proper vehicle operation and is not designed to prevent contact with objects surrounding the vehicle. When manoeuvring, always use the outside rearview mirror and inside rearview mirror and turn and check the surroundings to ensure it is safe to manoeuvre.

- The system is deactivated at speeds above

8 km/h (5 MPH). It is reactivated at lower speeds.

- **The MOD system is not designed to detect the surrounding stationary objects.**

The MOD system can inform the driver of moving objects near the vehicle when driving out of garages, manoeuvring in parking lots and in other such instances.

The MOD system detects moving objects by using image processing technology on the image shown in the display.

MOD SYSTEM OPERATION

The MOD system will turn on automatically under the following conditions:

- When the shift lever is in the R (Reverse) position.
- When the **<CAMERA>** button is pushed to activate the Intelligent Around View Monitor system on the display.
- When vehicle speed decreases below approximately 8 km/h (5 MPH).

The MOD system operates in the following conditions when the camera view is displayed:

- When the shift lever is in the P (Park) or N (Neutral) position and the vehicle is stopped, the MOD system detects the moving objects in the bird's-eye view. The MOD system will not operate if either door is opened. If outside rearview mirrors are folded, MOD may not operate properly.

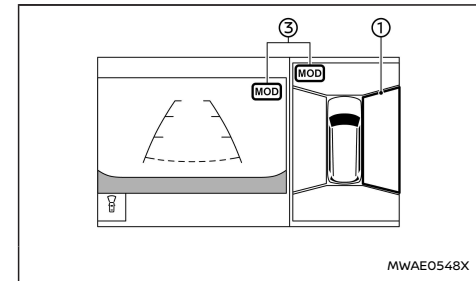
- When the shift lever is in the D (Drive) position, and the vehicle speed is below approximately 8 km/h (5 MPH), the MOD system detects moving objects in the front view or front-wide view.
- When the shift lever is in the R (Reverse) position and the vehicle speed is below approximately 8 km/h (5 MPH), the MOD system detects moving objects in the rear view or rear-wide view. The MOD system will not operate if the back door is open.

The MOD system does not detect moving objects in the front-side view. The MOD icon is not displayed on the screen when in this view.

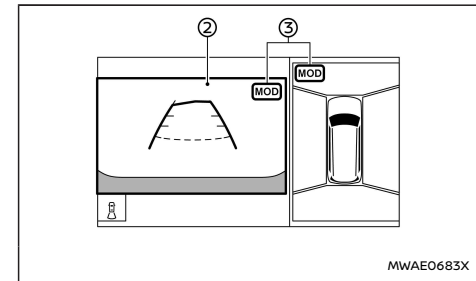
When the MOD system detects a moving object near the vehicle, the yellow frame will be displayed on the view where the object is detected and a chime will sound once. While the MOD system continues to detect moving objects, the yellow frame continues to be displayed.

NOTE:

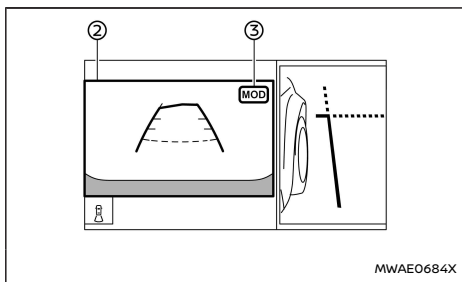
While the RCTA chime (where fitted) is beeping, the MOD system does not chime.



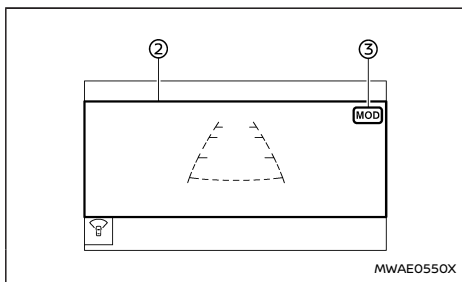
Front and bird's-eye views



Rear and bird's-eye views



Rear and front-side views



Front-wide view / rear-wide view

The screen layout in the illustration is for the Left-Hand Drive (LHD) model. For the Right-Hand Drive (RHD) model, the screen layout will be opposite.

In the bird's-eye view, the yellow frame ① is displayed on each camera image (front, rear, right, left) depending on where moving objects are detected.

The yellow frame ② is displayed on the front view, rear view, front-wide view and rear-wide view.

A green MOD icon ③ is displayed in the view where the MOD system is operative. A grey MOD icon ③ is displayed in the view where the MOD system is not operative.

If the MOD system is turned off, the MOD icon ③ is not displayed.

TURNING MOD ON AND OFF

The MOD system can be turned on and off using the vehicle information display. (See "Driver Assistance" (P.93).)

MOD SYSTEM LIMITATIONS

⚠ WARNING

Listed below are the system limitations for MOD. Failure to operate the vehicle in accordance with these system limitations could result in serious injury or death.

- Excessive noise (for example, audio system volume or open vehicle window) will interfere with the chime sound, and it may not be heard.
- The MOD system performance will be limited according to environmental conditions and surrounding objects such as:
 - When there is low contrast between background and the moving objects.
 - When there is blinking source of light.
 - When strong light such as another

vehicle's headlight or sunlight is present.

- When camera orientation is not in its usual position, such as when the outside rearview mirror is folded.
- When there is dirt, water drops or snow on the camera lens.
- When the position of the moving objects in the display is not changed.
- The MOD system might detect flowing water droplets on the camera lens, white smoke from the muffler, moving shadows, etc.
- The MOD system may not function properly depending on the speed, direction, distance or shape of the moving objects.
- If your vehicle sustains damage to the parts where the camera is installed, leaving it misaligned or bent, the sensing zone may be altered and the MOD system may not detect objects properly.
- When the temperature is extremely high or low, the screen may not display objects clearly. This is not a malfunction.

NOTE:

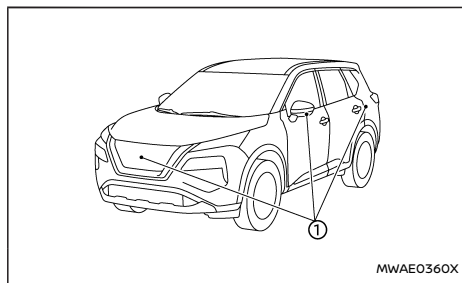
The green MOD icon will change to orange if one of the following has occurred.

- When the system is malfunctioning.
- When the component temperature reaches a high level.

- When the rear view camera has detected a blockage.

If the icon light continues to illuminate in orange, have the MOD system checked. It is recommended that you visit a NISSAN dealer or qualified workshop for this service.

SYSTEM MAINTENANCE



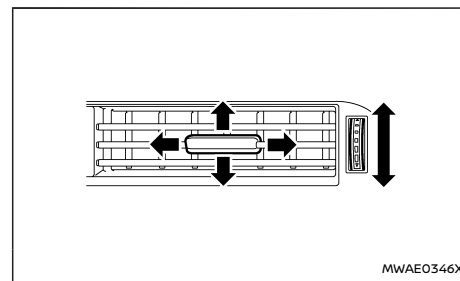
CAUTION

- Do not use alcohol, benzine or thinner to clean the camera. This will cause discoloration.
- Do not damage the camera as the monitor screen may be adversely affected.

If dirt, rain or snow accumulates on any of the cameras ①, the MOD system may not operate properly. Clean the camera by wiping with a cloth dampened with a diluted mild cleaning agent and then wiping with a dry cloth.

VENTS

CENTRE VENTS

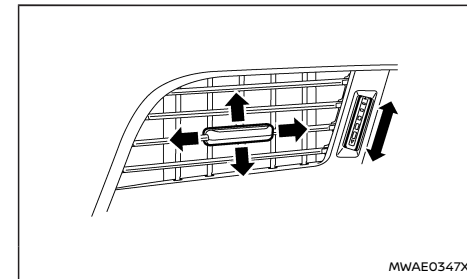


Right side

Open/close the vents by moving the control to either direction.

Adjust the air flow direction of the vents by moving the centre knob (up/down, left/right) until the desired position is achieved.

SIDE VENTS



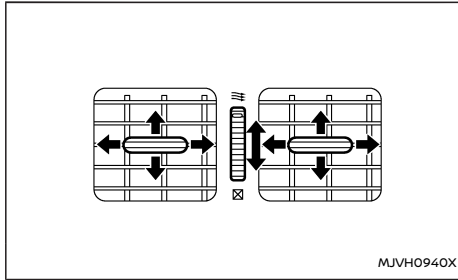
Right side

Open/close the vents by moving the control to either direction.

Adjust the air flow direction of the vents by moving the centre knob (up/down, left/right) until the desired position is achieved.

HEATER AND AIR CONDITIONER

REAR VENTS



Open/close the vents by moving the control to either direction.

- ☐ : This symbol indicates that the vents are open. Moving the side control to this direction will open the vents.
- ☒ : This symbol indicates that the vents are closed. Moving the side control to this direction will close the vents.

Adjust the air flow direction of the vents by moving the centre knob (up/down, left/right) until the desired position is achieved.

⚠ WARNING

- The heater and air conditioner operate only when the e-POWER system is running.
- Never leave children or adults who would normally require the support of others alone in the vehicle. Pets should not be left alone either. They could unknowingly activate switches or controls and inadvertently become involved in a serious accident and injure themselves. On hot, sunny days, temperatures in a closed vehicle could quickly become high enough to cause severe or possibly fatal injuries to people or animals.
- Do not use the recirculation mode for long periods as it may cause the interior air to become stale and the windows to fog up.
- Do not adjust the heating and air conditioning controls while driving so that full attention may be given to vehicle operation.

The heater and air conditioner operate when the e-POWER system is running. The air blower will operate even if the e-POWER system is turned off and the power switch is placed in the ON position.

NOTE:

- Odours from inside and outside the vehicle can build up in the air conditioner unit. Odour can enter the passenger compartment through the vents.
- When parking, set the heater and air conditioner controls to turn off air recirculation to

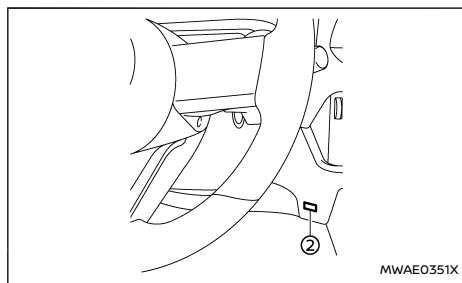
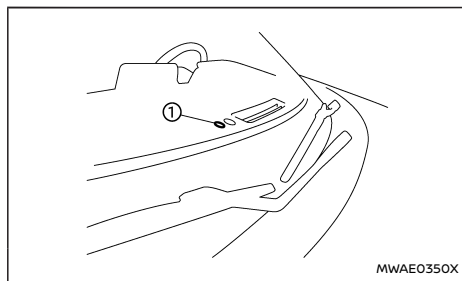
allow fresh air into the passenger compartment. This should help reduce odours inside the vehicle.

OPERATING TIPS

When the engine coolant temperature and outside air temperature are low, the air flow from the foot outlets may be limited when in the automatic mode. However, this is not a malfunction. After the coolant temperature warms up, air flow from the foot outlets will operate normally.

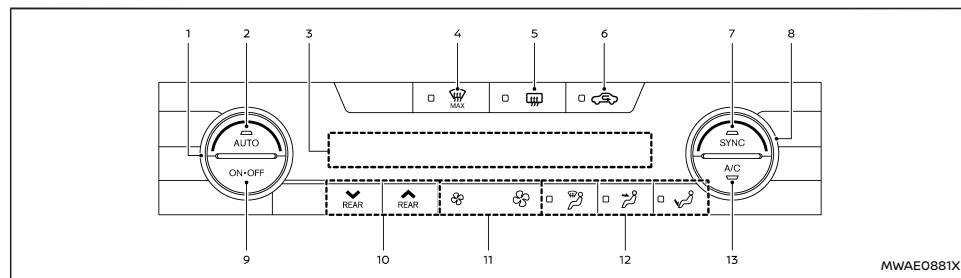
For rear temperature control (where fitted):

- The purpose of the rear temperature control is to vary the temperature of the rear air flow.
- The amount of air flow to the rear vents is primarily controlled by the front passenger's blower and mode settings.
- The amount of air flow to the rear vents is also affected by the rear temperature setting. Higher rear temperature settings have lower air flow amounts than cooler temperature settings. This condition ensures better comfort to the head and face area, while primary heating for the rear passenger seats is provided through the foot outlets.

Sensors:

The sensors ① and ②, located on the instrument panel, help maintain a constant temperature. Do not put anything on or around the sensors.

The layout in the illustration is for the Left-Hand Drive (LHD) model. For the Right-Hand Drive (RHD) model, the sensors ① and ② may be located on the opposite side.

AUTOMATIC AIR CONDITIONER (models with rear control)**Example**

1. Temperature control dial (driver's side)
2. **<AUTO>** (automatic) button
3. Display screen
4. (front defogger MAX) button
5. (rear window defogger) button
(See "Defogger switch" (P.132).)
6. (air recirculation) button
7. **<SYNC>** (synchronise) button
8. Temperature control dial (passenger's side)
9. **<ON-OFF>** button
10. Rear temperature control buttons
11. (fan speed control) buttons
12. Air flow control buttons
13. **<A/C>** (air conditioner) button

The layout of the buttons may vary depending on the models and specifications.

Automatic operation**Cooling and/or dehumidified heating (AUTO):**

This mode may be used all year round as the system automatically works to keep a constant temperature. Air flow distribution and fan speed are also controlled automatically.

1. Push the **<AUTO>** button on. (The indicator light on the button will illuminate.)
2. Turn the temperature control dial on the corresponding side to set the desired temperature.
 - You can individually set temperatures for the driver's side and front passenger's side when the indicator light on the **<SYNC>** button is not illuminated.

A visible mist may be seen coming from the vents in hot, humid conditions as the air is cooled rapidly. This does not indicate a malfunction.

Heating (A/C OFF):


The air conditioner does not activate in this mode. Use this mode when you only need to heat.

1. Push the **<AUTO>** button on. (The indicator light on the button will illuminate.)
2. Push the **<A/C>** button. (The indicator light will turn off.)
3. Turn the temperature control dial on the corresponding side to set the desired temperature.
 - You can individually set temperatures for the driver's side and front passenger's side when the indicator light on the **<SYNC>** button is not illuminated.
 - The temperature of the passenger compartment will be maintained automatically. Air flow distribution and fan speed are also controlled automatically.


NOTE:

- **Do not set the temperature lower than the outside air temperature or the system may not work properly.**
- **Not recommended if windows fog up.**


MAX defrosting/defogging:

Push the  button to turn on the MAX defogging/defrosting mode and quickly defog/defrost the windscreen. When this mode is turned on, the fan will be at its maximum speed, the A/C indicator light will turn on, and the air circulation will be fixed at the outside air circulation mode.


Do not set the temperature too low when the front defogger mode is on (the indicator light on the


 button is illuminated), because doing so may fog up the windscreen.

Manual operation**Fan speed control:**

Push the  buttons to manually control the fan speed.




Air intake control:

The air intake control mode will change each time the  button is pushed.

- When the indicator light is turned on, the air recirculates inside the vehicle.
- When the indicator light is turned off, the air flow is drawn from outside the vehicle.
- To switch to automatic control mode, push and hold the  button for about 2 seconds. The indicator light will blink, and then the air intake will be controlled automatically.

Air flow control:

Push the air flow control buttons to select the air flow outlets.

-  — Air flows mainly from centre and side vents.
-  — Air flows mainly from the foot outlet and partly from the defogger.
-  — Air flows mainly from the defogger.

Synchronise temperature settings:

Push the **<SYNC>** button to turn on the SYNC mode. (The indicator light on the button will turn on.)

When the SYNC mode is active, the driver's side

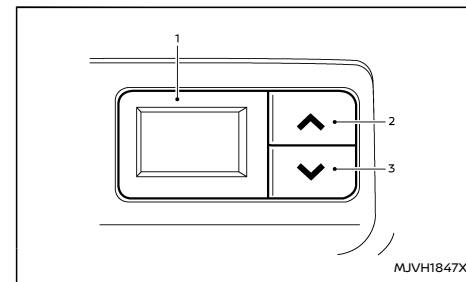
temperature control dial will control the driver's side, front passenger's side and rear temperatures.

When the passenger's side temperature control dial or the rear temperature control buttons are operated, it will cancel the SYNC mode of the individual zone. (The indicator light on the **<SYNC>** button will remain on.)

Operating both the passenger's side temperature control dial and the rear temperature control buttons will turn off the SYNC mode. (The indicator light on the **<SYNC>** button will turn off.) (See "Rear temperature control" (P.222).)

To turn the system off

Push the **<ON-OFF>** button.

Rear temperature control

1. Rear temperature display
2. " ^ " Rear temperature increase button
3. " v " Rear temperature decrease button

You can adjust the temperature for rear seat

passengers using the buttons located on the back side of the console box.

SERVICING AIR CONDITIONER

WARNING

The air conditioner system contains refrigerant under high pressure. To avoid personal injury, any air conditioner service should be done only by an experienced technician with the proper equipment.

The air conditioner system in your vehicle is charged with a refrigerant designed with the environment in mind.

This refrigerant will not harm the earth's ozone layer. However, it may contribute in a small part to global warming.

Special charging equipment and lubricant are required when servicing your vehicle's air conditioner. Using improper refrigerants or lubricants will cause severe damage to the air conditioner system. (See "Air conditioner system refrigerant and lubricant" (P.457).)

A NISSAN dealer or qualified workshop will be able to service your environmentally friendly air conditioner system.

Air conditioner filter

The air conditioner system is equipped with an air conditioner filter. To make sure the air conditioner heats, defogs, and ventilates efficiently, replace the filter according to the specified maintenance intervals listed in a separate maintenance booklet.

It is recommended to visit a NISSAN dealer or qualified workshop to replace the filter.

The filter should be replaced if the air flow decreases significantly or if windows fog up easily when operating the heater or air conditioner.

RADIO ANTENNA

The antenna is located on the rear part of the vehicle roof.

CAUTION

- **A build up of ice on the antenna can affect radio performance. Remove the ice to restore radio reception.**
- **When removing snow from the roof, do not apply strong force to the antenna. That may cause broken the antenna and roof panel dent.**
- **When using a high pressure car wash, keep the high pressure nozzle away from the antenna. The seal may be deformed or damaged.**
- **The radio performance may be affected if cargo carried on the roof blocks the radio signal. If possible, do not put cargo near the antenna.**

CAR PHONE OR CB RADIO

When installing a car phone or a CB radio in your vehicle, be sure to observe the following precautions, otherwise the new equipment may adversely affect the electronic control modules and electronic control system harness.

WARNING

- A mobile phone should not be used for any purpose while driving so full attention may be given to vehicle operation. Some jurisdictions prohibit the use of mobile phones while driving.
- If you must make a call while your vehicle is in motion, the hands-free mobile phone operational mode (where fitted) is highly recommended. Exercise extreme caution at all times so full attention may be given to vehicle operation.
- If a conversation in a moving vehicle requires you to take notes, pull off the road to a safe location and stop your vehicle before doing so.

CAUTION

- Keep the antenna as far away as possible from the electronic control modules.
- Keep the antenna wire more than 20 cm (8 in) away from the electronic control system harness. Do not route the antenna wire next to any harness.
- Adjust the antenna standing-wave ratio as recommended by the manufacturer.
- Connect the ground wire from the CB radio chassis to the body.

- For details, it is recommended you visit a NISSAN dealer or qualified workshop.

5 Starting and driving

Before starting e-POWER system	229	ECO mode	239
Precautions when starting and driving	229	SPORT mode	240
Exhaust gas (carbon monoxide)	229	Driving the vehicle	240
Three-way catalyst	230	Electric shift control system	240
Petrol Particulate Filter (GPF) (where fitted)	230	Four-Wheel Drive (4WD) (where fitted)	244
Tyre Pressure Monitoring System (TPMS)	231	Driver Assistance systems	245
On-pavement and off-road driving precautions	233	How to enable/disable the systems	249
Off-road recovery	233	Common troubleshooting guide	250
Driving safety precautions	233	Traffic Sign Recognition (TSR) (where fitted)	257
Care when driving	235	System operation	258
Loading luggage	235	How to enable/disable the TSR system	260
Driving in wet conditions	235	System temporarily unavailable	261
Driving in winter conditions	235	System malfunction	261
Push-button power switch	235	System maintenance	262
Precautions on push-button power		Emergency Lane Assist (ELA) (where fitted)	263
switch operation	235	ELA system operation	264
Intelligent Key system	235	How to enable/disable the ELA system	265
Operating range	236	ELA system limitations	266
Power switch positions	236	System temporarily unavailable	268
Intelligent Key battery discharge	237	System malfunction	269
Starting the e-POWER system	237	System maintenance	269
Drive Mode Selector	238	Blind Spot Warning (BSW) (where fitted)	270
OFF-ROAD mode (4WD models)	239	BSW system operation	271
SNOW mode (4WD models)	239	How to enable/disable the BSW system	272
STANDARD mode	239	BSW system limitations	273

BSW driving situations	273	Conventional (fixed speed) cruise control mode	306
System temporarily unavailable	275	ProPILOT Assist (where fitted)	309
System malfunction	275	ProPILOT Assist system operation	310
System maintenance	275	ProPILOT Assist switches	312
Intelligent Blind Spot Intervention (where fitted)	276	ProPILOT Assist system display and indicators	313
Intelligent Blind Spot Intervention system operation	277	Turning the conventional (fixed speed) cruise control mode ON	314
How to enable/disable the Intelligent Blind Spot Intervention system	278	Operating ProPILOT Assist	315
Intelligent Blind Spot Intervention system limitations	279	How to enable/disable the Steering Assist	317
Intelligent Blind Spot Intervention driving situations	280	How to cancel the ProPILOT Assist system	318
System temporarily unavailable	283	Intelligent Cruise Control (ICC)	319
System malfunction	283	Steering Assist	331
System maintenance	283	Conventional (fixed speed) cruise control mode	336
Rear Cross Traffic Alert (RCTA) (where fitted)	284	Intelligent Emergency Braking with Pedestrian Detection system	338
RCTA system operation	285	Intelligent Emergency Braking with Pedestrian Detection system operation	339
How to enable/disable the RCTA system	286	Turning the Intelligent Emergency Braking with Pedestrian Detection system ON/OFF	341
RCTA system limitations	287	Intelligent Emergency Braking with Pedestrian Detection system limitations	342
System temporarily unavailable	288	System temporarily unavailable	346
System malfunction	288	System maintenance	347
System maintenance	288	Intelligent Forward Collision Warning (where fitted)	348
Speed limiter (where fitted)	289	Intelligent Forward Collision Warning system operation	350
Speed limiter operations	289	Turning the Intelligent Forward Collision Warning system ON/OFF	351
Cruise control (where fitted)	291	Intelligent Forward Collision Warning system limitations	352
Precautions on cruise control	292		
Cruise control operations	292		
Intelligent Cruise Control (ICC) (where fitted)	293		
How to select the cruise control mode	295		
Vehicle-to-vehicle distance control mode	295		

System temporarily unavailable	354	Anti-lock Braking System (ABS)	370
System malfunction	355	Electronic Stability Programme (ESP) system	372
System maintenance	355	How to turn off the ESP system	373
Intelligent Driver Alertness (where fitted)	355	Brake Force Distribution	373
Intelligent Driver Alertness system operation	356	Chassis control	374
How to enable/disable the Intelligent Driver Alertness system warning	357	Intelligent Trace Control	374
Intelligent Driver Alertness system limitations	357	Hill Start Assist system	375
System malfunction	358	Hill descent control system (where fitted)	375
Rear Automatic Braking (RAB) (where fitted)	358	Hill descent control switch	376
RAB system operation	359	Parking sensor (sonar) system	377
Turning the RAB system ON/OFF	360	System operation	378
RAB system limitations	361	Turning on and off the parking sensor (sonar) function	379
System malfunction	362	Parking sensor (sonar) system limitations	380
System maintenance	362	System temporarily unavailable	380
Fuel Efficient Driving Tips	363	System maintenance	381
Increasing fuel economy and reducing Carbon Dioxide emissions	364	ProPILOT Park (where fitted)	381
Parking	364	ProPILOT Park switch	382
Trailer towing	366	ProPILOT Park screen	382
Operating precautions	366	Selecting the parking method	383
Tyre pressure	366	ProPILOT Park operation	384
Safety chains	366	ProPILOT Park pause	387
Trailer brakes	366	ProPILOT Park deactivation	387
Trailer detection (where fitted)	367	About the ProPILOT Park parking methods	388
Trailer Sway Control	367	Adjusting the parking position	390
Coupling device installation (for Europe)	368	Changing the direction of parking control travel	391
Electric power steering	369	Parking position detection function	391
Brake system	369	Cameras and parking sensors (sonar) used for ProPILOT Park	393
Braking precautions	369	ProPILOT Park precautions	393
Brake assist	370		

ProPILOT Park malfunctions	394	Anti-freeze	397
ProPILOT Park settings	394	12-volt battery	397
Parking sensor (sonar) detection conditions and limitations	395	Draining of coolant water	397
Intelligent Around View Monitor detection conditions and limitations	395	Tyre equipment	398
ProPILOT Park detection conditions and limitations	396	Special winter equipment	398
Cold weather driving	397	Driving on snow or ice	398
Freeing a frozen door lock	397	Active noise cancellation/Active sound enhancement	399
		Active noise cancellation	399
		Active sound enhancement	399

BEFORE STARTING e-POWER SYSTEM

WARNING

The driving characteristics of your vehicle will change remarkably by any additional load and its distribution, as well as by adding optional equipment (roof racks, etc.). Your driving style and speed must be adjusted according to the circumstances. Especially when carrying heavy loads, your speed must be reduced adequately.

- Make sure the area around the vehicle is clear.
- Visually inspect tyres for their appearance and condition. Measure and check the tyre pressure for proper inflation.
- Check that all windows and lights are clean.
- Adjust the seat and head restraint positions.
- Adjust the inside and outside rearview mirror positions.
- Fasten your seat belt and ask all passengers to do the same.
- Check that all doors are closed.
- Check the operation of the warning lights when the power switch is placed in the ON position.
- Maintenance items in the "8. Maintenance and do-it-yourself" section should be checked periodically.

PRECAUTIONS WHEN STARTING AND DRIVING

WARNING

- Do not leave children or adults who would normally require the support of others alone in your vehicle. Pets should not be left alone either. They could accidentally injure themselves or others through inadvertent operation of the vehicle. Also, on hot, sunny days, temperatures in a closed vehicle could quickly become high enough to cause severe or possibly fatal injuries to people or animals.
- Properly secure all cargo with ropes or straps to help prevent it from sliding or shifting. Do not place cargo higher than the seatbacks. In a sudden stop or collision, unsecured cargo could cause personal injury.

NOTE:

During the first few months after purchasing a new vehicle, if you smell strong odours of Volatile Organic Compounds (VOCs) inside the vehicle, ventilate the passenger compartment thoroughly. Open all the windows before entering or while in the vehicle. In addition, when the temperature in the passenger compartment rises, or when the vehicle is parked in direct sunlight for a period of time, turn off the air recirculation mode of the air conditioner and/or open the windows to allow sufficient fresh air into the passenger compartment.

EXHAUST GAS (carbon monoxide)

WARNING

- Do not breathe exhaust gas; it contains colourless and odourless carbon monoxide. Carbon monoxide is dangerous. It can cause unconsciousness or death.
- If you suspect that exhaust fumes are entering the vehicle, drive with all windows fully open, and have the vehicle inspected immediately.
- Do not run the engine in closed spaces such as a garage.
- Do not park the vehicle with the engine running for an extended period of time.
- Keep the back door closed while driving, otherwise exhaust gas could be drawn into the passenger compartment. If you must drive with the back door open, follow these precautions:
 - Open all the windows.
 - Turn the air recirculation mode off and set the fan speed control to the highest level to circulate the air.
- If a special body or other equipment is added for recreational or other usage, follow the manufacturer's recommendation to prevent carbon monoxide entry into the vehicle. (Some recreational vehicle appliances such as stoves, refrigerators, heaters, etc. may also generate carbon monoxide.)
- If electrical wiring or other cable connec-

tions must pass to a trailer through the seal on the back door or the body, follow the manufacturer's recommendation to prevent carbon monoxide entry into the vehicle.

- The exhaust system and body should be inspected by a qualified mechanic whenever:
 - Your vehicle is raised while being serviced.
 - You suspect that exhaust fumes are entering into the passenger compartment.
 - You notice a change in the sound of the exhaust system.
 - You have had an accident involving damage to the exhaust system, underbody, or rear of the vehicle.

THREE-WAY CATALYST

The three-way catalyst is an emission control device installed in the exhaust system. Exhaust gases in the three-way catalyst are burned at high temperatures to help reduce pollutants.

WARNING

- The exhaust gas and the exhaust system are very hot. Keep people, animals and flammable materials away from the exhaust system components.
- Do not stop or park the vehicle over flammable materials such as dry grass,

wastepaper or rags. They may ignite and cause a fire.

CAUTION

- Do not use leaded petrol. Deposits from leaded petrol will seriously reduce the three-way catalyst's ability to help reduce exhaust pollutants.
- Keep your engine tuned up. Malfunctions in the ignition, fuel injection, or electrical systems can cause overrich fuel flow into the three-way catalyst, causing it to overheat. Do not keep driving if the engine misfires, or if noticeable loss of performance or other unusual operating conditions are detected. Have the vehicle inspected. It is recommended you visit a NISSAN dealer or qualified workshop for this service.
- Avoid driving with an extremely low fuel level. Running out of fuel could cause the engine to misfire, damaging the three-way catalyst.
- Do not push or tow your vehicle to start the engine.

PETROL PARTICULATE FILTER (GPF) (where fitted)

Your vehicle is equipped with a Petrol Particulate Filter (GPF) as a part of the emission control system.

The GPF filters carbon particles from the exhaust gas, thus reducing the emission of soot to the environment.

Under normal driving conditions, the accumulated carbon particles in the GPF are burned-off regularly, thus emptying the filter from carbon particles. In this way, the GPF is "regenerated" and again fully operational to filter the carbon particles from the exhaust gas as intended.

CAUTION

- Under certain driving conditions, the GPF may become saturated/clogged because these driving conditions prevent automatic regeneration of the filter. In this case, a message appears in the vehicle information display.

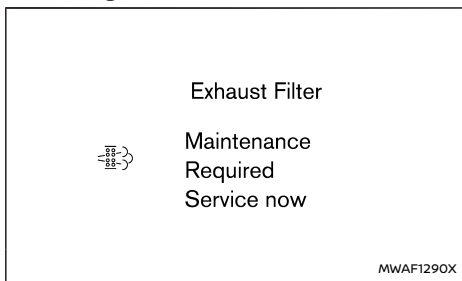
Exhaust Filter
Self Clean in Progress



Engine idle speed Increased
See Owner's Manual

- When the [Exhaust Filter/Self Clean in Progress] message appears in the vehicle information display, the engine speed is increasing automatically to burn carbon particles. When this message is displayed, keep an appropriate driving, provided that

legal and safety conditions allow, until the message is turned off.



- When the [Exhaust Filter/Maintenance Required Service now] message appears in the vehicle information display, always visit the nearest NISSAN dealer or qualified workshop as soon as possible. The Malfunction Indicator Light (MIL) may also illuminate. Extended driving with the message displayed and/or the MIL illuminated may lead to damage to the exhaust filter system.
- When the [Exhaust Filter/Maintenance Required Service now] message appears in the vehicle information display, cruise control (where fitted), Intelligent Cruise Control (ICC) (where fitted) and ProPILOT Assist (where fitted) system will be deactivated.

What you can do to prevent the GPF from becoming saturated/clogged:

- Avoid repeated and frequent short journeys in

which the engine does not reach its normal operating temperature.

- Regularly drive the vehicle at speeds over 60 km/h (37 MPH) for an extended period of time (more than 30 minutes).

TYRE PRESSURE MONITORING SYSTEM (TPMS)

Each tyre should be checked monthly when cold and inflated to the inflation pressure recommended by the vehicle manufacturer on the vehicle placard or tyre inflation pressure label. (If your vehicle has tyres of a different size than the size indicated on the vehicle placard or tyre inflation pressure label, you should determine the proper tyre inflation pressure for those tyres.)

As an added safety feature, your vehicle has been equipped with a Tyre Pressure Monitoring System (TPMS) that illuminates a low tyre pressure telltale when one or more of your tyres is significantly under-inflated. Accordingly, when the low tyre pressure telltale illuminates, you should stop and check all your tyres as soon as possible, and inflate them to the proper pressure. Driving on a significantly under-inflated tyre causes the tyre to overheat and can lead to tyre failure. Under-inflation also reduces fuel efficiency and tyre tread life, and may affect the vehicle's handling and stopping ability.

Please note that the TPMS is not a substitute for proper tyre maintenance, and it is the driver's responsibility to maintain correct tyre pressure, even if under-inflation has not reached the level to trigger illumination of the TPMS low tyre pressure telltale.

Your vehicle has also been equipped with a TPMS malfunction indicator to indicate when the system is not operating properly. The TPMS malfunction indicator is combined with the low tyre pressure telltale. When the system detects a malfunction, the telltale will flash for approximately one minute and then remain continuously illuminated. This sequence will continue upon subsequent vehicle start-ups as long as the malfunction exists. When the malfunction indicator is illuminated, the system may not be able to detect or signal low tyre pressure as intended. TPMS malfunctions may occur for a variety of reasons, including the installation of replacement or alternate tyres or wheels on the vehicle that prevent the TPMS from functioning properly. Always check the TPMS malfunction telltale after replacing one or more tyres or wheels on your vehicle to ensure that the replacement or alternate tyres and wheels allow the TPMS to continue to function properly.

Additional information

- The TPMS will activate only when the vehicle is driven at speeds above 25 km/h (16 MPH). Also, this system may not detect a sudden drop in tyre pressure (for example a flat tyre while driving).
- The low tyre pressure warning light does not automatically turn off when the tyre pressure is adjusted. After the tyre is inflated to the recommended pressure, reset the tyre pressures registered in your vehicle and then drive the vehicle at speeds above 25 km/h (16 MPH) to activate the TPMS and turn off the low tyre telltale.

pressure warning light. Use a tyre pressure gauge to check the tyre pressure.

- The [Low Tyre Pressure] warning appears in the vehicle information display when the low tyre pressure warning light is illuminated and low tyre pressure is detected. The [Low Tyre Pressure] warning turns off when the low tyre pressure warning light turns off.

The [Low Tyre Pressure] warning does not appear if the low tyre pressure warning light illuminates to indicate a TPMS malfunction.

- Tyre pressure rises and falls depending on the heat caused by the vehicle's operation and the outside temperature. Do not reduce the tyre pressure after driving because the tyre pressure rises after driving. Low outside temperature can lower the temperature of the air inside the tyre which can cause a lower tyre inflation pressure. This may cause the low tyre pressure warning light to illuminate. If the warning light illuminates in low ambient temperature, check the tyre pressure for all four tyres.
- Depending on a change in the outside temperature, the low tyre pressure warning light may illuminate even if the tyre pressure has been adjusted properly. Adjust the tyre pressure to the recommended COLD tyre pressure again when the tyres are cold, and reset the TPMS.
- You can also check the tyre pressure of all tyres in the vehicle information display. (See "Trip computer" (P.113).)

For additional information, see "Low tyre pressure

warning light" (P.87) and "Tyre Pressure Monitoring System (TPMS)" (P.403).

⚠ WARNING

If the low tyre pressure warning light illuminates while driving, avoid sudden steering manoeuvres or abrupt braking, reduce vehicle speed, pull off the road to a safe location and stop the vehicle as soon as possible. Driving with under-inflated tyres may permanently damage the tyres and increase the likelihood of tyre failure. Serious vehicle damage could occur and may lead to an accident and could result in serious personal injury. Check the tyre pressure for all four tyres. Adjust the tyre pressure to the recommended COLD tyre pressure shown on the tyre placard to turn the low tyre pressure warning light OFF. If you have a flat tyre, repair it with an emergency tyre puncture repair kit as soon as possible. (See "Flat tyre" (P.403) for repairing a flat tyre.)

TPMS resetting

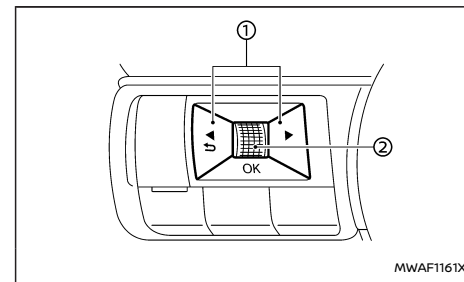
To keep the TPMS functioning properly, the reset operation must be performed in the following cases.

- when the tyre pressure is adjusted
- when a tyre or a wheel is replaced
- when the tyres are rotated

Perform the following procedures to reset the TPMS.

1. Park the vehicle in a safe and level place.

2. Apply the parking brake and push the P position switch to shift to the P (Park) position.
3. Adjust the tyre pressure on all four tyres to the recommended COLD tyre pressure shown on the tyre placard. Use a tyre pressure gauge to check the tyre pressure.
4. Place the power switch in the ON position.



5. Press the ◀ ▶ button ① until [Settings] appears and then push the scroll dial ②.
6. Use the scroll dial ② until [Tyre Pressures] is selected, and press the scroll dial ②.
7. Use the scroll dial ② until [Calibrate] is selected, and press the scroll dial ②.
8. Use the scroll dial ② until [Yes] is selected, and press the scroll dial ② to reset the TPMS.
9. After resetting the TPMS, drive the vehicle for several minutes at speeds above 25 km/h (16 MPH).

If the low tyre pressure warning light illuminates after the resetting operation, it may indicate that

ON-PAVEMENT AND OFF-ROAD DRIVING PRECAUTIONS

the TPMS is not functioning properly. Have the system checked by a NISSAN dealer or qualified workshop.

For information regarding the low tyre pressure warning light, see "Low tyre pressure warning light" (P.87).

Utility vehicles have a significantly higher roll-over rate than other types of vehicles.

They have higher ground clearance than passenger cars to make them capable of performing in a variety of on-pavement and off-road applications. This gives them a higher centre of gravity than ordinary cars. An advantage of higher ground clearance is a better view of the road, allowing you to anticipate problems. However, they are not designed for cornering at the same speeds as conventional passenger cars any more than low-slung sports cars are designed to perform satisfactorily under off-road conditions. If at all possible, avoid sharp turns or abrupt manoeuvres, particularly at high speeds. As with other vehicles of this type, failure to operate this vehicle correctly may result in loss of control or vehicle rollover.

Be sure to read "Driving safety precautions" (P.233).

OFF-ROAD RECOVERY

If the right side or left side wheels leave the road surface, maintain control of the vehicle by following the procedure below. Please note that this procedure is only a general guide. The vehicle must be driven as appropriate based on the conditions of the vehicle, road and traffic.

1. Remain calm and do not overreact.
2. Do not apply the brakes.
3. Maintain a firm grip on the steering wheel with both hands and try to hold a straight course.
4. When appropriate, slowly release the accelerator pedal to gradually slow the vehicle.

5. If there is nothing in the way, steer the vehicle to follow the road while the vehicle speed is reduced. Do not attempt to drive the vehicle back onto the road surface until vehicle speed is reduced.
6. When it is safe to do so, gradually turn the steering wheel until both tyres return to the road surface. When all tyres are on the road surface, steer the vehicle to stay in the appropriate driving lane.
 - If you decide that it is not safe to return the vehicle to the road surface based on vehicle, road or traffic conditions, gradually slow the vehicle to a stop in a safe place off the road.

DRIVING SAFETY PRECAUTIONS

Your vehicle is designed for both normal and off-road use. However, avoid driving in deep water or mud as your vehicle is mainly designed for leisure use, unlike a conventional off-road vehicle.

Remember that Two-Wheel Drive (2WD) models are less capable than Four-Wheel Drive (4WD) models for rough road driving and extrication when stuck in deep snow, mud, or the like.

Please observe the following precautions:

WARNING

- **Drive carefully when off the road and avoid dangerous areas. Every person who drives or rides in this vehicle should be seated with their seat belt fastened. This will keep you and your passengers in position when driving over rough terrain.**

- Do not drive across steep slopes. Instead drive either straight up or straight down the slopes. Off-road vehicles can tip over sideways much more easily than they can forward or backward.
- Many hills are too steep for any vehicle. If you drive up them, you may stall. If you drive down them, you may not be able to control your speed. If you drive across them, you may roll over.
- Do not shift ranges while driving on down-hill grades as this could cause loss of control of the vehicle.
- Stay alert when driving to the top of a hill. At the top there could be a drop-off or other hazard that could cause an accident.
- If your engine stalls or you cannot make it to the top of a steep hill, never attempt to turn around. Your vehicle could tip or roll over. Always back straight down in R (Reverse) range. Never back down in N (Neutral), using only the brake, as this could cause loss of control.
- Heavy braking going down a hill could cause your brakes to overheat and fade, resulting in loss of control and an accident. Apply brakes lightly and use a low range to control your speed.
- Unsecured cargo can be thrown around when driving over rough terrain. Properly secure all cargo so it will not be thrown forward and cause injury to you or your passengers.

- To avoid raising the centre of gravity excessively, do not exceed the rated capacity of the roof rack (where fitted) and evenly distribute the load. Secure heavy loads in the cargo area as far forward and as low as possible. Do not equip the vehicle with tyres larger than specified in this manual. This could cause your vehicle to roll over.
- Do not grip the inside or spokes of the steering wheel when driving off-road. The steering wheel could move suddenly and injure your hands. Instead drive with your fingers and thumbs on the outside of the rim.
- Before operating the vehicle, ensure that the driver and all passengers have their seat belts fastened.
- Always drive with the floor mats in place as the floor may become hot.
- Lower your speed when encountering strong crosswinds. With a higher centre of gravity, your vehicle is more affected by strong side winds. Slower speeds ensure better vehicle control.
- Do not drive beyond the performance capability of the tyres, even with 4WD engaged.
- For 4WD equipped vehicles, do not attempt to raise two wheels off the ground and shift the transmission to any drive or reverse position with the e-POWER system running. Doing so may result in unexpected vehicle movement which could

- result in serious vehicle damage or personal injury.
- Do not attempt to test a 4WD equipped vehicle on a 2-wheel dynamometer (such as the dynamometers used by some states for emissions testing), or similar equipment even if the other two wheels are raised off the ground. Make sure you inform test facility personnel that your vehicle is equipped with 4WD before it is placed on a dynamometer. Using the wrong test equipment may result in unexpected vehicle movement which could result in serious vehicle damage or personal injury.
- When a wheel is off the ground due to an unlevel surface, do not spin the wheel excessively (4WD model).
- Accelerating quickly, sharp steering manoeuvres or sudden braking may cause loss of control.
- If at all possible, avoid sharp turning manoeuvres, particularly at high speeds. Your vehicle has a higher centre of gravity than a conventional passenger car. The vehicle is not designed for cornering at the same speeds as conventional passenger cars. Failure to operate this vehicle correctly could result in loss of control and/or a rollover accident.
- Always use tyres of the same type, size, brand, construction (bias, bias-belted or radial), and tread pattern on all four wheels. Install traction devices on the front

CARE WHEN DRIVING

wheels when driving on slippery roads and drive carefully.

- Be sure to check the brakes immediately after driving in mud or water. See “Brake system” (P.369) for wet brakes.
- Avoid parking your vehicle on steep hills. If you get out of the vehicle and it rolls forward, backward or sideways, you could be injured.
- Whenever you drive off-road through sand, mud or water as deep as the wheel hub, more frequent maintenance may be required. See the maintenance information in a separate maintenance booklet.

Driving your vehicle to fit the circumstances is essential for your safety and comfort. As a driver, you should be the one who knows best how to drive in the given circumstances.

LOADING LUGGAGE

Loads and their distribution and the attachment of equipment (coupling devices, roof baggage carriers, etc.) will considerably change the driving characteristics of the vehicle. Your driving style and speed must be adjusted according to the circumstances.

DRIVING IN WET CONDITIONS

- Avoid accelerating or stopping suddenly.
- Avoid sharp turning or lane changing suddenly.
- Avoid following too close to the vehicle in front.

When water covers the road surface with water puddles, small water streams, etc., reduce speed to prevent hydroplaning which can cause skidding and loss of control. Worn tyres will increase this risk.

DRIVING IN WINTER CONDITIONS

- Drive cautiously.
- Avoid accelerating or stopping suddenly.
- Avoid sharp turning or lane changing suddenly.
- Avoid sudden steering.
- Avoid following too close to the vehicle in front.

PUSH-BUTTON POWER SWITCH

PRECAUTIONS ON PUSH-BUTTON POWER SWITCH OPERATION

WARNING

Do not operate the push-button power switch while driving the vehicle except in an emergency. (The e-POWER system will stop when the power switch is pushed 3 consecutive times or the power switch is pushed and held for more than 2 seconds.) If the e-POWER system stops while the vehicle is being driven, this could lead to a crash and serious injury.

Before operating the push-button power switch, be sure to push the P position switch to engage the P (Park) position.

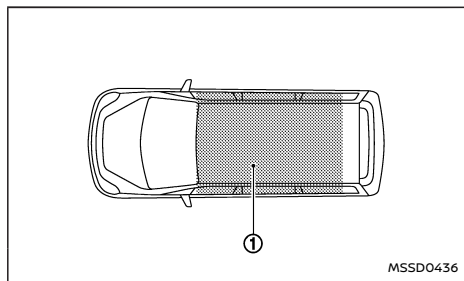
INTELLIGENT KEY SYSTEM

The Intelligent Key system can operate the power switch without taking the key out from your pocket or bag. The operating environment and/or conditions may affect the Intelligent Key system operation.

CAUTION

- Be sure to carry the Intelligent Key with you when operating the vehicle.
- Never leave the Intelligent Key inside the vehicle when you leave the vehicle.

OPERATING RANGE



The Intelligent Key can only be used for starting the e-POWER system when the Intelligent Key is within the specified operating range ① as illustrated.

When the Intelligent Key battery is almost discharged or strong radio waves are present near the operating location, the Intelligent Key system's operating range becomes narrower and may not function properly.

If the Intelligent Key is within the operating range, it is possible for anyone, even someone who does not carry the Intelligent Key, to push the power switch to start the e-POWER system.

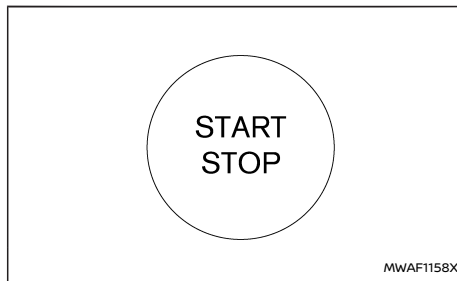
- The cargo room area is not included in the operating range, but the Intelligent Key may function.
- If the Intelligent Key is placed on the instrument panel, inside the glove box, door pocket or the corner of the interior compartment, the Intelligent Key may not function.

- If the Intelligent Key is placed near the door or window outside the vehicle, the Intelligent Key may function.

POWER SWITCH POSITIONS

CAUTION

- **Do not leave the vehicle for extended periods of time when the power switch is in the ON position and the e-POWER system is not running. This can discharge the 12-volt battery.**
- **Use electrical accessories with the e-POWER system running to avoid discharging the 12-volt battery. If you must use accessories while the e-POWER system is not running, do not use them for extended periods of time and do not use multiple electrical accessories at the same time.**



When the power switch is pushed without depressing the brake pedal, the power switch will illuminate.

Push the power switch:

- once to change to ON.
- twice to change to OFF.

When the READY to drive indicator light illuminates in the meter, the vehicle can be driven.

ON position

The ignition system and the electrical accessory power activate at this position without the e-POWER system turned on.

The ON position has a battery saver feature that will place the power switch in the OFF position, if the vehicle is not running, after some time under the following conditions:

- power switch is in the ON position.
- e-POWER system is stopped.

The battery saver feature will be cancelled if any of the following occur:

- power switch is in the OFF position.
- e-POWER system is running.

The power switch will automatically be placed in the OFF position when the following conditions have been met and 10 minutes have passed.

- When the power switch is placed in the ON position.
- When the vehicle is parked.

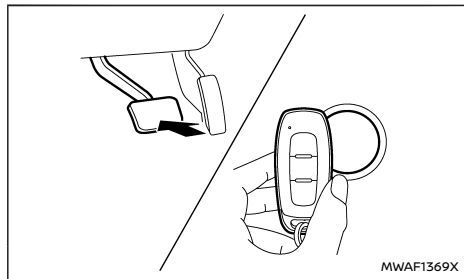
OFF position

The e-POWER system is turned off in this position.

Auto ACC position

With the vehicle in the P (Park) position, the Intelligent Key with you and the power switch placed from ON to OFF, the outside rearview mirror remote control, etc. can still be used for a period of time.

INTELLIGENT KEY BATTERY DISCHARGE



If the battery of the Intelligent Key is discharged, or environmental conditions interfere with the Intelligent Key operation, start the e-POWER system according to the following procedure:

1. Firmly depress the brake pedal.
2. Push the power switch.
3. Touch the power switch with the Intelligent Key as illustrated. (A chime will sound.)

4. Push the power switch while depressing the brake pedal within 10 seconds after the chime sounds. The e-POWER system will start.

After step 3 is performed, when the power switch is pushed without depressing the brake pedal, the power switch position will change to ON.

NOTE:

- **When the power switch is placed in the ON position or the e-POWER system is started by the above procedures, the [Key Battery Low] warning appears on the vehicle information display even if the Intelligent Key is inside the vehicle. This is not a malfunction. To turn off the warning, touch the power switch with the Intelligent Key again.**
- **If the [Key Battery Low] warning appears on the vehicle information display, replace the battery as soon as possible. (See "Intelligent Key battery" (P.439).)**

STARTING THE e-POWER SYSTEM

1. Confirm the parking brake is applied.
2. Confirm that the vehicle is in the P (Park) position.

The e-POWER system is designed not to operate unless the vehicle is in the P (Park) position or the shift position is in the N (Neutral) position.

The Intelligent Key must be carried with you when operating the power switch.

3. Firmly depress the brake pedal and push the power switch to place the vehicle in the READY to drive position.

To place the vehicle in the READY to drive position immediately, push and release the power switch while depressing the brake pedal with the power switch in any position. The READY to drive indicator light in the meter illuminates.

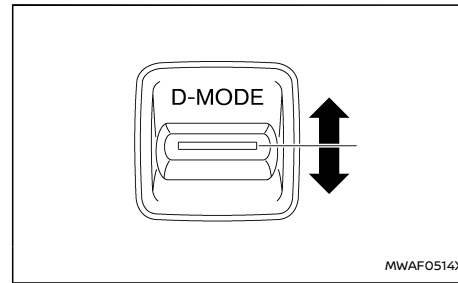
To stop the e-POWER system, push the P position switch, and push the power switch to the OFF position.

NOTE:

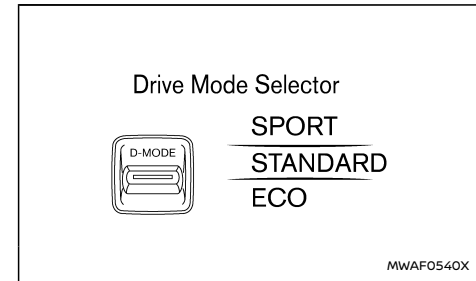
- **After placing the power switch in the ON position, the engine may start before the READY to drive indicator light stops blinking and then illuminates.**
- **When the remaining Lithium ion (Li-ion) battery level is low, it may take a period of time until the READY to drive indicator light stops blinking and then illuminates after pushing the power switch. In the meantime, the Energy Flow, etc. will not appear.**

DRIVE MODE SELECTOR

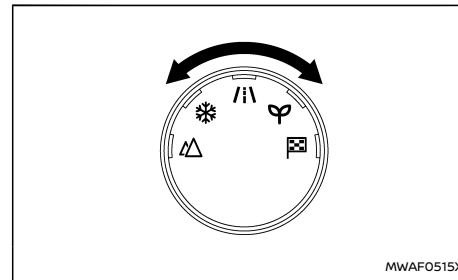
- The brake pedal may be firm since the pedal is operated before the e-POWER system starts. In this case, depress the brake pedal more firmly than usual.
- You may hear a sound when the brake pedal is depressed with the e-POWER system off. This does not indicate a malfunction.
- If the e-POWER system cannot be started, place the power switch in the OFF position and wait for 5 seconds or more and then restart the e-POWER system.



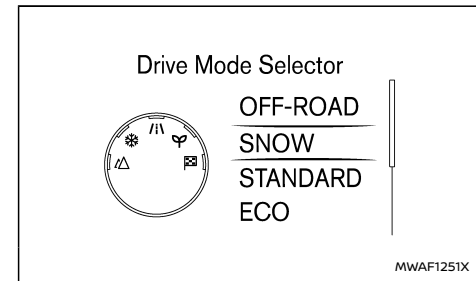
Drive Mode Selector: 2WD models



Vehicle information display: 2WD models



Drive Mode Selector: 4WD models



Vehicle information display: 4WD models

Multiple driving modes can be selected by using the Drive Mode Selector.

2WD: [SPORT], [STANDARD] and [ECO]

To change the mode, push the Drive Mode Selector up or down.

4WD: [OFF-ROAD], [SNOW], [STANDARD], [ECO] and [SPORT]

To change the mode, turn the Drive Mode Selector right or left.

NOTE:

When the Drive Mode Selector selects a mode, the mode may not switch immediately. This is not a malfunction.

The current mode is displayed in the vehicle information display. The mode list will appear in the vehicle information display and you can select the mode.

NOTE:

The mode list will be turned off in approximately 5 seconds after the mode is selected. You can also clear the message by pushing the scroll dial on the steering wheel.

If the driving mode cannot be switched using the Drive Mode Selector when the power switch is in the ON position, have the system checked. It is recommended you visit a NISSAN dealer or qualified workshop for this service.

The STANDARD mode will be selected first each time the power switch is placed in the ON position.

⚠ WARNING

- **Do not stare at the Drive Mode Selector or the display while driving so that full attention may be given to vehicle operation.**
- **Avoid abrupt acceleration, steering or sudden braking especially on slippery roads. Otherwise tyre slip, skid or tailswing occurs; this may cause an accident.**

OFF-ROAD MODE (4WD models)

Allows for easier driving or starting on a bumpy road surface such as an uneven dirt road or a steep uphill slope or through sand.

SNOW MODE (4WD models)

This mode makes it easier to start and drive on snowy roads and frozen roads by precise twin motor control.

STANDARD MODE

This is the standard mode that is most suitable for normal driving.

ECO MODE

Assists the driver's ECO-driving. Acceleration profile is optimised for efficient driving. Engine running logic is fully optimised for economy. Optimum regenerative braking profile for cruising or city driving can be selected by shifting between D (Drive) and B position.

NOTE:

Selecting the ECO mode will not necessarily improve fuel economy as many driving factors influence its effectiveness.

Operation

Select the ECO mode using the Drive Mode Selector. The ECO indicator illuminates.

When the accelerator pedal is depressed within the range of economy drive, the ECO indicator illuminates in green. When the accelerator pedal is

depressed above the range of economy drive, the ECO indicator turns off.

The ECO indicator will not illuminate in the following cases:

- When the shift lever is in the R (Reverse) position.
- When the vehicle speed is below 3.2 km/h (2 MPH) or over 144 km/h (90 MPH).
- When the cruise control (where fitted) or the Intelligent Cruise Control (ICC) system (where fitted) is operated.

ECO Mode Customise

When the ECO mode of the "ECO Cruise Control" and/or "ECO Climate Control" is ON, more actual fuel economy is achieved by placing priority on fuel efficiency. It can be set when the ECO mode is selected. To activate or deactivate this function, see "ECO Settings" (P.95).

- **ECO Cruise Control (where fitted)**
When the setting is ON, the fuel efficiency while cruising will be improved by lowering the acceleration target from normal (setting OFF) mode.
- **ECO Climate Control**
When the setting is ON, the fuel efficiency will be improved by reducing the performance of the air conditioning system.

NOTE:

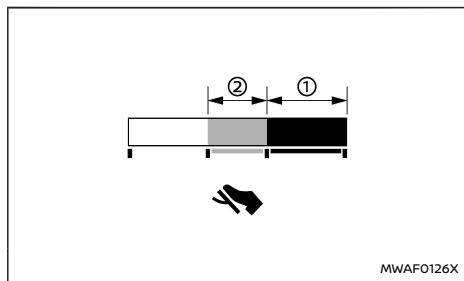
When the vehicle speed is reduced (for example, when the vehicle is driven on an uphill road from a flat road), it will take more time to return to the previously set speed than normal mode.

Tyre ECO advice (where fitted)

The "Tyre ECO advice" is a function to show an ECO advice message in the vehicle information display when low tyre pressure is detected. To activate or deactivate this function, see "ECO Settings" (P.95).

When the setting is ON, the ECO Drive Report display shows [ECO Advice Adjust Tyre Pressures]. You can switch the display to the Tyre Pressures display by pushing the ◀ ▶ button on the steering wheel.

ECO Pedal Guide function



The ECO Pedal Guide display can be selected in the vehicle information display in the ECO mode. (See "4. [ECO Pedal Guide]" (P.115).) Use the ECO Pedal Guide function for improving fuel economy.

When the ECO Pedal Guide bar is in the green range ①, it indicates that the vehicle is being driven within range of the super economy drive.

When the ECO Pedal Guide bar is in the light green

range ②, it indicates that the vehicle is being driven within range of the economy drive.

If the ECO Pedal Guide bar is out of the green range ① and ②, it indicates that the accelerator pedal is depressed over the range of economy drive.

The ECO Pedal Guide bar is not displayed when:

- The vehicle speed is less than approximately 4 km/h (2 MPH).
- The shift lever is in the P (Park), N (Neutral) or R (Reverse) position.

SPORT MODE

- Adjusts e-motor torque response to improve driving agility.
- The steering system adapts to give the driver a more engaging experience in sporty driving scenes. This system can be turned on and off in the settings menu of the vehicle information display. (See "Driver Assistance" (P.93).)

NOTE:

In the SPORT mode, fuel economy may be reduced.

DRIVING THE VEHICLE

ELECTRIC SHIFT CONTROL SYSTEM

This vehicle is electronically controlled to produce maximum available power and smooth operation.

The recommended operating procedures for this vehicle are shown on the following pages.

Starting the vehicle

1. After placing the vehicle in the READY to drive position, fully depress the footbrake pedal before moving the shift lever to the D (Drive) position.

The shift lever of this vehicle is designed so that the footbrake pedal must be depressed before shifting from the P (Park) position to any driving position while the e-POWER system is running.

The shift position cannot be moved out of the P (Park) position and into any of the other positions if the power switch is placed in the OFF position.

2. Keep the footbrake pedal depressed, and move the shift lever to the D (Drive) position.
3. Release the parking brake and footbrake pedal, and then gradually start the vehicle in motion by depressing the accelerator pedal.

WARNING

- **Do not depress the accelerator pedal while shifting from P (Park) or N (Neutral) to R (Reverse) or D (Drive) position. Always depress the brake pedal until shifting is completed. Failure to do so could cause**

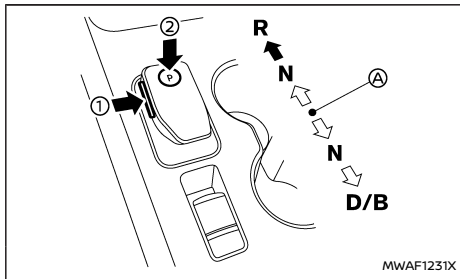
you to lose control, which could result in an accident.

- Never attempt to shift to either the P (Park) or R (Reverse) position while the vehicle is moving forward and P (Park), D (Drive) or B position while the vehicle is reversing. This could cause an accident or damage the transmission.

CAUTION

- To avoid possible damage to your vehicle; when stopping the vehicle on an uphill slope, do not hold the vehicle by depressing the accelerator pedal. The footbrake should be used for this purpose.
- Do not hang items on the shift lever. This may cause an accident due to a sudden start.

Shifting



Ⓐ Idle position (central position)

To move the shift lever,

➡: Push the button ① to shift.

⇨: Shift without pushing the button ①.

Push the P position switch ② to shift to the P (Park) position.

When in the D (Drive) position, slide along the gate to select B position.

NOTE:

- Confirm that the vehicle is in the desired shift position by checking the shift indicator located on the shift lever or shown on the vehicle information display.
- To place the vehicle into the D (Drive) position from the B position, move the shift lever into the D (Drive) position again.

After placing the power switch in the READY to drive position, fully depress the brake pedal, and move the shift lever to any of the preferred shift positions.

NOTE:

- The vehicle automatically applies the P (Park) position when the power switch is placed in the OFF position. However, be sure to push the P position switch to shift into the P (Park) position when parking the vehicle, because this automatic shift function to P (Park) position is supplemental.
- When the READY to drive indicator light "READY" or "⚡" does not illuminate, the shift position cannot be changed to the D

(Drive), B or R (Reverse) position even if the power switch is placed in the ON position.

- If the following conditions have been met, the shift position may be changed to the P (Park) position automatically.
 - When the driver's seat belt is not fastened.
 - When the driver's door is opened.

⚠ WARNING

- The shift lever is always in the centre position when released. When the power switch is placed in the READY to drive position, the driver needs to confirm that the vehicle is in the P (Park) position. The indicator light above the P by the shift lever is illuminated and the P is displayed on the vehicle information display. If the vehicle is in the D (Drive) or R (Reverse) position when the power switch is placed in the READY to drive position, this may cause a sudden start which could result in an accident.
- On a hilly road, do not allow the vehicle to roll backwards while in the D (Drive) position or B position, or allow the vehicle to roll forward while in the R (Reverse) position. This may cause an accident.
- Do not place the shift lever in the N (Neutral) position while driving. The regenerative brake is not operated, which could result in an accident.
- If the regenerative brake does not work

sufficiently, depress the brake pedal to decrease the vehicle speed.

- When stopping or parking on an uphill or downhill road, depress the brake pedal and stop the vehicle. If the vehicle continues to be stopped with only the accelerator pedal depressed and the brake pedal released, the electric motor for driving could cause overheating. When stopping the vehicle, release the accelerator pedal and depress the brake pedal.


CAUTION

- Do not slide the shift lever while pushing the P position switch. This may damage the electric motor.
- When switching to the preferred position by operating the shift lever, check that the shift lever returns to the centre position by releasing your hand from the lever. Holding the shift lever in a mid-way position may also damage the shift control system.
- Do not operate the shift lever while the accelerator pedal is depressed, except when switching to the B position. This may cause a sudden start which could result in an accident.
- The following operations are not allowed because excessive force would be applied to the electric motor for driving and this may result in damage to the vehicle:
 - Moving the shift lever to the R (Reverse) position when driving forward

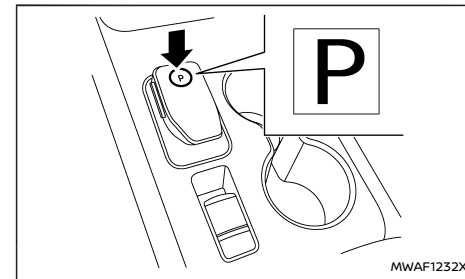
– Moving the shift lever to the D (Drive) or B position when reversing

If these operations are attempted, a chime sounds and the vehicle shifts to the N (Neutral) position.

NOTE:

- Do not intentionally reverse with the shift lever placed in the D (Drive) or B position on an incline or move your vehicle forward with the shift lever placed in the R (Reverse) position on a decline.
- When the Lithium ion (Li-ion) battery is fully charged, regenerated electric power is consumed by the engine started with the power generator. In that case, the engine sound may be loud, but this is not a malfunction. No fuel is used in this situation.
- When the P position switch is pushed while driving, the operation is cancelled. (The buzzer sounds and the shift position before being operated is maintained.)
- If the accelerator pedal is depressed when the vehicle is stopped and the shift lever is placed in the N (Neutral) position, the power limitation indicator light  will illuminate. (See “Power limitation indicator light” (P.90).)

P (Park):



Use this position when the vehicle is parked or when placing the vehicle in the READY to drive position. Make sure that the vehicle is completely stopped before selecting the P (Park) position. In order to switch to the P (Park) position, push the P position switch as shown in the illustration once the vehicle has come to a complete stop. If the P position switch is pushed while the vehicle is in motion, a chime sounds and the current shift position is maintained. After switching to the P (Park) position, apply the parking brake. When parking on a hill, apply the parking brake first while keeping the footbrake pedal depressed then push the P position switch and place the vehicle in the P (Park) position. For the parking brake operation, see “Parking brake” (P.189).

NOTE:

- While the vehicle is stationary, if the shift position is other than P (Park), when the power switch is placed in the OFF position,

the shift position will automatically switch to the P (Park) position.

- If the P position switch is pushed while sliding the shift lever, the shift position will not switch to the P (Park) position. When pushing the P position switch, be sure to first allow the shift lever to return to its centre position.

R (Reverse):

Use this position to reverse. Make sure that the vehicle is completely stopped before selecting the R (Reverse) position. **The brake pedal must be depressed and the shift lever button needs to be pushed to move the shift lever from the idle position to R (Reverse). If the vehicle is placed in the R (Reverse) position when driving forward, the chime will sound and the vehicle will switch into the N (Neutral) position.**

N (Neutral):

Neither forward nor reverse gear is engaged. The vehicle can be placed in the READY to drive position in this position.

Do not shift to the N (Neutral) position while driving. The regenerative brake system does not operate in the N (Neutral) position. However, the vehicle brakes will still stop the vehicle.

To shift to the N (Neutral) position:

- When the vehicle is in the P (Park) position, slide the shift lever forward or backward by one notch with the brake pedal depressed, and hold the shift lever at the position for longer than 1 second.

- When the vehicle is in the D (Drive) or B position, slide the shift lever forward by one notch with the brake pedal depressed, and hold the shift lever at the position for longer than 1 second.

- When the vehicle is in the R (Reverse) position, slide the shift lever backward by one notch with the brake pedal depressed, and hold the shift lever at the position for longer than 1 second.

D (Drive):

Use this position for all normal forward driving. **If the vehicle is placed in the D (Drive) position while reversing, the chime will sound and the vehicle will switch into the N (Neutral) position.**

B:

Use the B position for downhill driving. When the B position is used, more regenerative brake is applied when the accelerator pedal is released in comparison to the D (Drive) position.

Regenerative brake:

- The effectiveness of the regenerative brake is increased when the vehicle is placed in the B position. If the vehicle speed is too fast, depress the brake pedal accordingly.
- The effectiveness of the brake of the regenerative brake may be decreased on a slippery road, when the Li-ion battery is fully charged or the Li-ion battery temperature is low.

Neutral hold mode function (where fitted)

This function enables you to turn off the engine with the vehicle in the N (Neutral) position. While this function is activated, the vehicle can be moved by pushing with hand even if the power switch is in the OFF position. When using this function, release the electronic parking brake.

WARNING

- Use this function on a level surface only. Failure to do so may cause the vehicle to move accidentally and could result in a collision or serious personal injury.
- When the power switch is placed in the ON position after activating this function, depress the brake pedal to stop the vehicle because the shift lever is in the N (Neutral) position.
- If this function is not activated regardless of proper operation, transmission may malfunction. It is recommended that you visit a NISSAN dealer or qualified workshop for this service.

To activate the Neutral hold mode, perform the following operations.

1. Push the power switch to start the engine.
2. Release the electronic parking brake and Automatic brake hold function.
3. Depress and hold the brake pedal. Slide the shift lever to move the transmission out of the P (Park) position.

4. Push the P position switch.
5. Slide the shift lever to the N (Neutral) position, and hold it for approximately 0.5 seconds until N appears in the vehicle information display and then return the lever to the central position.
6. Slide the shift lever to the N (Neutral) position again, and hold it for approximately 0.5 seconds, until a message [Park Gear & Park Brake not Applied] appears in the vehicle information display. (See "74. Neutral Hold Mode activated indicator (where fitted)" (P.111).)
7. Place the power switch in the OFF position. The e-POWER system will turn off with holding the N (Neutral) position.

To exit the Neutral hold mode, place the vehicle in other than N (Neutral) position.

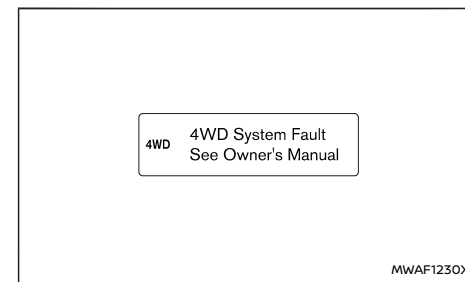
NOTE:

- It is necessary to perform the steps 4 through 6 within approximately 5 seconds and steps 5 and 6 within approximately 0.5 seconds to prevent incorrect operation.
- When the power switch is placed in the OFF position while the shift lever is in the N (Neutral) position, a message will appear in the vehicle information display. (See "73. Neutral Hold Mode guidance indicator (where fitted)" (P.111).)
- If the Neutral hold mode is unavailable, a message will appear in the vehicle information display. (See "75. [Neutral Hold Mode was not activated.] indicator (where fitted)"

(P.111.) To activate the Neutral hold mode, wait for a while without shifting operation and then perform the operations again.

FOUR-WHEEL DRIVE (4WD) (where fitted)

If any malfunction occurs in the Four-Wheel Drive (4WD) system while the e-POWER system is running, a warning message appears in the vehicle information display.



If the [4WD System Fault] warning appears, there may be a malfunction in the 4WD system. Reduce vehicle speed and have your vehicle checked by a NISSAN dealer or qualified workshop as soon as possible.

If the warning message continues to be displayed after the above operation, have your vehicle checked by a NISSAN dealer or qualified workshop as soon as possible.

⚠ WARNING

- For 4WD equipped vehicles, do not attempt to raise two wheels off the ground and shift the transmission to any drive or reverse position with the e-POWER system running. Doing so may result in unexpected vehicle movement which could

DRIVER ASSISTANCE SYSTEMS

result in serious vehicle damage or personal injury.









- Do not attempt to test an 4WD equipped vehicle on a 2-wheel dynamometer (such as the dynamometers used by some states for emissions testing) or similar equipment even if the other two wheels are raised off the ground. Make sure that you inform the test facility personnel that your vehicle is equipped with 4WD before it is placed on a dynamometer. Using the wrong test equipment may result in unexpected vehicle movement which could result in serious vehicle damage or personal injury.









CAUTION





- Do not operate the e-POWER system on a free roller when any of the wheels raised.
- The power train may be damaged if you continue driving with the [4WD System Fault] warning on.

When the vehicle is in the P (Park) position, the operation noise may be heard from the lower part of the vehicle. This is not a malfunction.

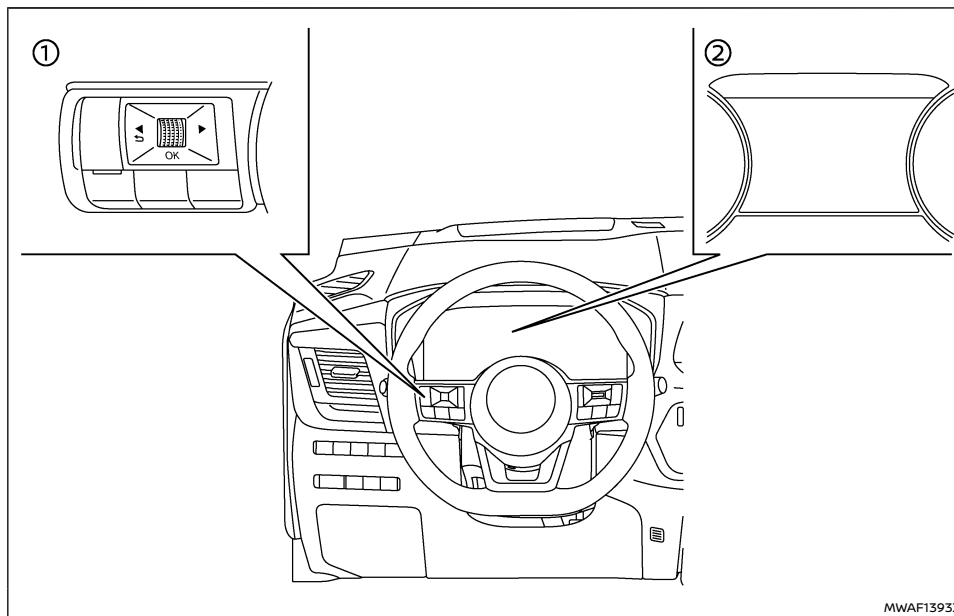
Each Driver Assistance system is designed to help the driver in different ways as they drive. The following Driver Assistance systems (where fitted) are available on this vehicle:

Category	System	Symbol	System description (See the specified page for detailed information.)	Page
Forward Driving Aids	Intelligent Emergency Braking with Pedestrian Detection		Assists the driver with a warning and/or braking operation when there is a risk of a forward collision with the vehicle ahead in the travelling lane, or with a pedestrian or a cyclist.	338
	Intelligent Forward Collision Warning		Helps alert the driver when there is a sudden braking of a second vehicle travelling in front of the vehicle ahead in the same lane.	348
	Intelligent Cruise Control (ICC) (models with ProPILOT Assist system)		Intelligent Cruise Control (ICC) <ul style="list-style-type: none"> ● Helps the driver maintain a selected distance from the vehicle ahead and can reduce the speed to match a slower vehicle ahead. ● Decelerates the vehicle to a standstill when a vehicle ahead slows to a stop. 	319
			Conventional (fixed speed) cruise control mode <ul style="list-style-type: none"> ● Allows the driver to drive the vehicle at a fixed speed without keeping his/her foot on the accelerator pedal. 	336
	Intelligent Cruise Control (ICC) (models without ProPILOT Assist system)		Intelligent Cruise Control (ICC) <ul style="list-style-type: none"> ● Helps the driver maintain a selected distance from the vehicle ahead and can reduce the speed to match a slower vehicle ahead. ● Decelerates the vehicle to a standstill when a vehicle ahead slows to a stop. 	293
			Conventional (fixed speed) cruise control mode <ul style="list-style-type: none"> ● Allows the driver to drive the vehicle at a fixed speed without keeping his/her foot on the accelerator pedal. 	306
	Cruise control (models without ProPILOT Assist system or ICC)		Allows the driver to drive the vehicle at a fixed speed without keeping his/her foot on the accelerator pedal.	291
	Speed limiter		Allow the driver to set the desired speed limit.	289

Category	System	Symbol	System description (See the specified page for detailed information.)	Page
Side Driving Aids (Lane and Blind Spot)	Emergency Lane Assist (ELA)		<ul style="list-style-type: none"> Warns the driver when the vehicle approaches the road edge, solid line or dashed line with an indicator and a steering wheel vibration. Assist the driver to return the vehicle to the travelling lane. 	263
	Blind Spot Warning (BSW)		Warns the driver of a vehicle in an adjacent lane when changing lanes with an indicator.	270
	Intelligent Blind Spot Intervention		<ul style="list-style-type: none"> Warns the driver of a vehicle in an adjacent lane when changing lanes. Assists the driver to return the vehicle to the centre of the travelling lane. 	276
	Steering Assist		Assists the driver to help keep the vehicle within the centre of the travelling lane (this system is integrated in the ProPILOT Assist system).	331
Rear Driving Aids	Rear Cross Traffic Alert (RCTA)		Assists the driver when reversing out from a parking space by detecting other vehicles approaching from the right or left of the vehicle.	284
	Rear Automatic Braking (RAB)		Assists the driver when the vehicle is reversing and approaching stationary objects directly behind the vehicle by providing a warning and automatic braking if needed.	358
Parking Aids	Rear view monitor	-	Shows a rear view of the vehicle when the shift lever is placed in the R (Reverse) position.	201
	Intelligent Around View Monitor	-	Assists the driver in parking situations by showing various views of the position of the vehicle in a split screen format.	207
	Moving Object Detection (MOD)	-	Informs the driver of moving objects near the vehicle in parking situations.	216
	Parking sensor (sonar) system	-	Informs the driver with a visual and audible alert of stationary obstacles near the bumpers.	377
	ProPILOT Park		Assists the driver to park the vehicle (parallel parking, reverse bay parking and forward bay parking).	381
ProPILOT Assist	ProPILOT Assist		Consists of Intelligent Cruise Control (ICC) and Steering Assist.	309

Category	System	Symbol	System description (See the specified page for detailed information.)	Page
Other Driving Aids	High beam assist		Switches the headlights to the low beam automatically when an oncoming vehicle or leading vehicle appears in front of your vehicle.	121
	Adaptive LED headlight		Changes the area illuminated by the headlights automatically when an oncoming vehicle or leading vehicle appears in front of your vehicle.	123
	Traffic Sign Recognition (TSR)		Provides the driver with information about the most recently detected speed limit, using the speed limit display and overspeed warning function.	257
	Intelligent Driver Alertness		Helps alert the driver when a lack of attention or driving fatigue is detected.	355
	Hill Start Assist	-	Helps prevent the vehicle from rolling backwards in the time it takes the driver to release the brake pedal and apply the accelerator when the vehicle is stopped on a hill.	375

HOW TO ENABLE/DISABLE THE SYSTEMS



MWAFL393X

- ① Steering-wheel-mounted controls (left side)
 ② Vehicle information display

The following systems (where fitted) can be enabled or disabled using the settings menu in the vehicle information display. Select each setting

item using the scroll dial on the steering-wheel-mounted controls.

- Intelligent Emergency Braking with Pedestrian Detection
- Intelligent Forward Collision Warning

- Emergency Lane Assist (ELA) system
- Blind Spot Warning (BSW)
- Intelligent Blind Spot Intervention*
- Speed Limit Link
- CRUISE Navi Link
- Steering Assist
- Rear Cross Traffic Alert (RCTA)
- Rear Automatic Braking (RAB)
- Moving Object Detection (MOD)
- Parking sensor (sonar) system
- Traffic Sign Recognition (TSR)
- Intelligent Driver Alertness





*: To operate the Intelligent Blind Spot Intervention systems, you need to push the ProPILOT Assist switch or the dynamic driver assistance switch after enabling each system in the settings menu.

Driver Assistance display

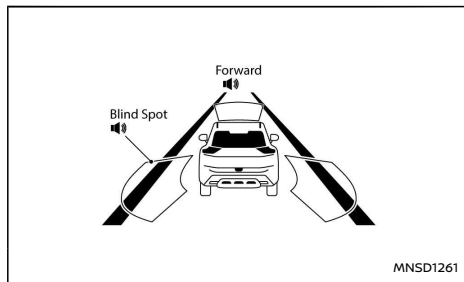
The Driver Assistance display appears in the vehicle information display when it is selected using the scroll dial.

The status of the following systems (where fitted) can be shown in each zone of the display.

Zone	Driving Aid
Forward	Intelligent Emergency Braking with Pedestrian Detection
	Intelligent Forward Collision Warning
Blind Spot	Blind Spot Warning (BSW)
	Intelligent Blind Spot Intervention

- When any of the “Warning” systems are enabled, the “” mark is shown in each zone.
- When any of the “Intervention” systems are enabled, the “” mark is shown in each zone.
- When no system is enabled, [OFF] is shown in each zone.
- When the “” mark (yellow) or “” mark (yellow) flashes or illuminates in each zone, the system cannot be used.

The display changes as the following examples:



Blind Spot	Blind Spot Warning (BSW)	Enabled (outline)
	Intelligent Blind Spot Intervention	Disabled





COMMON TROUBLESHOOTING GUIDE






Zone	Driving Aid	Status
Forward	Intelligent Emergency Braking with Pedestrian Detection	Enabled (outline)
	Intelligent Forward Collision Warning	



Some of the Driver Assistance systems use the common parts (camera, radar, etc.) to function. When a pop-up warning message appears in the vehicle information display, or the warning light flashes/illuminates, check the system condition. For details, see “System temporarily unavailable” and “System malfunction” sections in this Owner’s Manual for each applicable system.

NOTE: The displayed messages may differ depending on the model (for example, wording, spelling, etc.).




For camera and radar temporary blockage

Warning message/Warning light	Symptom	Possible cause	System affected	Action to take
[Unavailable Camera Temperature High]	High camera temperature	Direct sunlight/High cabin temperature	Intelligent Blind Spot Intervention and Steering Assist	When the interior temperature is reduced, the system resumes automatically. (Push the ProPILOT Assist switch or the dynamic driver assistance switch to turn back on the Intelligent Blind Spot Intervention systems.)
[Currently Unavailable Front Camera High Temperature] and  /  /  Illuminating	—	—	TSR, ELA and Intelligent Emergency Braking with Pedestrian Detection	When the interior temperature is reduced, the system resumes automatically.
[Unavailable Low Visibility]	Poor camera visibility	Direct sunlight	Steering Assist	When the condition no longer exists, the system resumes automatically.
	Camera obstruction	Windscreen glass misted, frozen or covered with dirt		Clean the windscreen glass of the camera area. Use the wipers and the defogger to help clear the windscreen glass.
[Currently Unavailable Poor Visibility] and  Illuminating	Poor camera visibility	Direct sunlight	Intelligent Emergency Braking with Pedestrian Detection	When the condition no longer exists, the system resumes automatically.






Warning message/Warning light	Symptom	Possible cause	System affected	Action to take
[Temporarily Disabled Camera Blocked See Owner's Manual] and  /  /  Illuminating	Camera obstruction	windscreen glass misted, frozen or covered with dirt	ELA, Intelligent Emergency Braking with Pedestrian Detection and TSR	Clean the windscreen glass of the camera area. Use the wipers and the defogger to help clear the windscreen glass.
[Not Available Visibility is impaired]	Poor visibility/Undetectable lane marker	Bad weather	Steering Assist	When the condition no longer exists, push the ProPILOT Assist switch to turn off the ProPILOT Assist system and push the switch again to turn back on the system.
[Temporarily Disabled Front Radar Blocked]	Front radar obstruction	Inclement weather (rain, fog, snow, etc.)	ICC, ProPILOT Assist	When the condition no longer exists, the system resumes automatically. (Push the ProPILOT Assist switch or Cruise ON/OFF switch to turn back on the ICC system.)
		Sensor covered with dirt or obstructed		Clean the front radar sensor area on the front of the vehicle.
		Roads with limited road structures or buildings		When the condition no longer exists, the system resumes automatically. (Push the ProPILOT Assist switch or Cruise ON/OFF switch to turn back on the ICC system.)
[Temporarily Disabled Front Radar Blocked See Owner's Manual] and  /  Illuminating	Front radar obstruction	Inclement weather (rain, fog, snow, etc.)	ELA, Intelligent Emergency Braking with Pedestrian Detection and Intelligent Forward Collision Warning	When the condition no longer exists, the system resumes automatically.
		Roads with limited road structures or buildings		Clean the front radar sensor area on the front of the vehicle.
		Sensor covered with dirt or obstructed		

Warning message/Warning light	Symptom	Possible cause	System affected	Action to take
—	Front radar interruption	Interference from another radar source	ICC, ProPILOT Assist	When the condition no longer exists, the system resumes automatically. (Push the ProPILOT Assist switch or Cruise ON/OFF switch to turn back on the ICC system.)
[Currently Unavailable Radar Inhibited] and  Illuminating			Intelligent Emergency Braking with Pedestrian Detection and Intelligent Forward Collision Warning	When the condition no longer exists, the system resumes automatically.
[Not Available Side Radar obstructed]	Side radar obstruction	Radar blockage	BSW, Intelligent Blind Spot Intervention and RCTA	Clean the rear side radar area on the rear of the vehicle. When the condition no longer exists, the system resumes automatically. (Push the ProPILOT Assist switch or dynamic driver assistance switch to turn back on the Intelligent Blind Spot Intervention.)
[Temporarily Disabled Side Radar Blocked See Owner's Manual] and  Illuminating			ELA	
[Unavailable Slippery Road]	Poor road condition	Slippery road	Intelligent Blind Spot Intervention, ICC and ProPILOT Assist	When the condition no longer exists, push the ProPILOT Assist switch or the dynamic driver assistance switch or the Cruise ON/OFF switch to turn back on each system.
[Not Available, Parking Brake On]	System cancel	Electronic parking brake application	ProPILOT Assist	When the condition no longer exists, push the ProPILOT Assist switch to turn off the ICC system and push the switch again to turn back on the ICC system.
[Press brake pedal]	No electronic parking brake application	Driver's door open (vehicle stopped)	ProPILOT Assist	Step on the brake pedal immediately.

For system temporarily unavailable

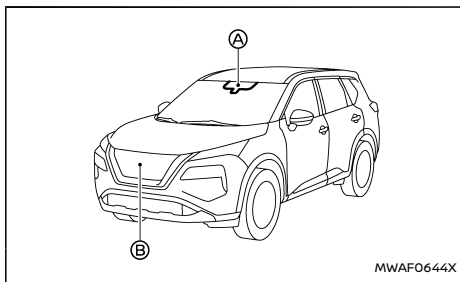
Warning light/warning message	Possible cause	System to check	Action to take
[Currently Unavailable ESP OFF] and  Illuminating	ESP turned off	ELA, Intelligent Emergency Braking with Pedestrian Detection	Turn on the ESP.
 Illuminating	ESP turned off	RAB	Turn on the ESP.
[Currently Not Available]	ESP turned off	Intelligent Blind Spot Intervention, ICC and ProPILOT Assist	Turn on the ESP.
	SNOW mode or OFF-ROAD mode selected (4WD models)		Select a mode other than SNOW and OFF-ROAD.
[Currently Not Available] and  Illuminating	The direction of the front camera is significantly misaligned.	ELA	Have the system checked.

For system malfunction

Warning light/Warning message	Symptom	System to check	Action to take
[System fault See Owner's Manual] and  Illuminating	System malfunction	Intelligent Emergency Braking with Pedestrian Detection and Intelligent Forward Collision Warning	Stop the vehicle in a safe location. Turn the e-POWER system off and restart the e-POWER system. If the warning light/message continues to illuminate, have the system checked. It is recommended that you visit a NISSAN dealer or qualified workshop for this service.
[System fault See Owner's Manual] and  Illuminating		RAB	
[System fault See Owner's Manual]		TSR, RAB, BSW, Intelligent Blind Spot Intervention, RCTA, ICC, Steering Assist	
[System fault See Owner's Manual] and  /  /  Illuminating		ELA, Intelligent Driver Alertness and TSR	
[Parking Sensor system fault See Owner's Manual]		Parking sensor (sonar) system	

Camera, radar and sonar locations

The camera, radar and parking sensors that are used by each Driver Assistance systems are located on the front and rear of the vehicle. For the maintenance of each component, see "System maintenance" section in this Owner's Manual for each application system.

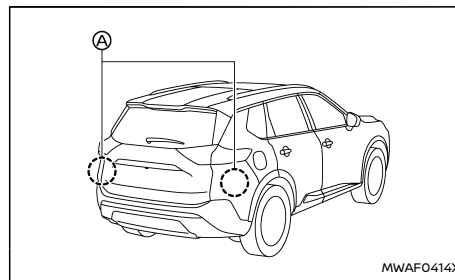


Vehicle front

- Ⓐ Front camera unit
 - Intelligent Emergency Braking with Pedestrian Detection
 - Intelligent Blind Spot Intervention
 - Steering Assist
 - Emergency Lane Assist (ELA)
 - High beam assist
 - Adaptive LED headlight
 - Traffic Sign Recognition (TSR)
- Ⓑ Front radar sensor
 - Intelligent Emergency Braking with Pedes-

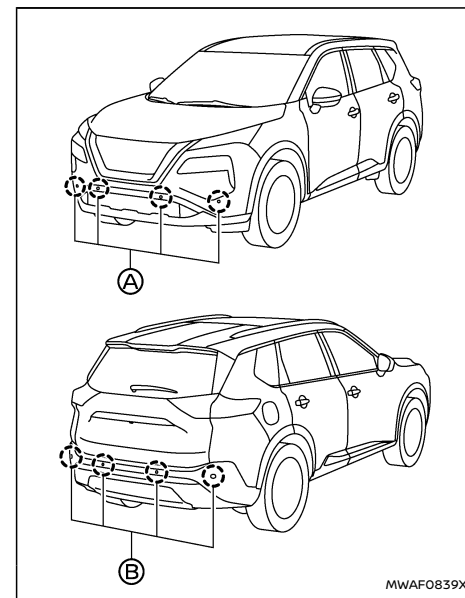
Vehicle front

- Intelligent Forward Collision Warning
- Intelligent Cruise Control (ICC)
- Emergency Lane Assist (ELA)



Vehicle rear

- Ⓐ Side radar sensor
 - Blind Spot Warning (BSW)
 - Intelligent Blind Spot Intervention
 - Rear Cross Traffic Alert (RCTA)
 - Emergency Lane Assist (ELA)



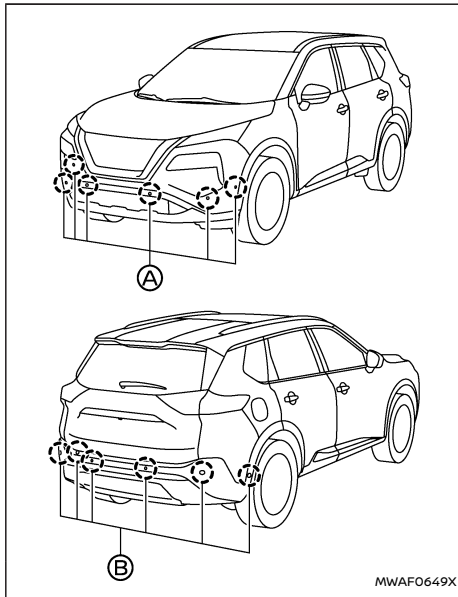
8 sensors

Parking sensors

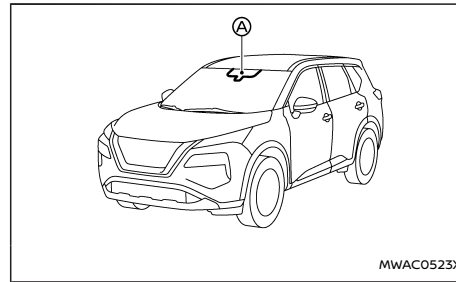
- Ⓐ Front parking sensors
 - Parking sensor (sonar) system
 - ProPILOT Park
- Ⓑ Rear parking sensors
 - Rear Automatic Braking (RAB)
 - Parking sensor (sonar) system

TRAFFIC SIGN RECOGNITION (TSR) (where fitted)

— ProPILOT Park



12 sensors



The Traffic Sign Recognition (TSR) system provides the driver with information about the most recently detected speed limit. The system captures the road sign information with the multi-sensing front camera unit (A) located on the windshield in front of the inside rearview mirror and displays the detected signs in the vehicle information display and in the Head Up Display (HUD) (where fitted). (See "Head Up Display (HUD) (where fitted)" (P.118).)

The speed limit displayed is based on a combination of the map data and live camera recognition. When a change of the speed limit is detected, the system notifies the driver with a speed display icon and a chime (once). If the vehicle exceeds the speed limit, the system warns the driver by flashing the speed display icon and issues warning chime (four times). The overspeed warning chime can be cancelled if the driver takes action to slow down or pushes the scroll dial on the steering-wheel-mounted controls.

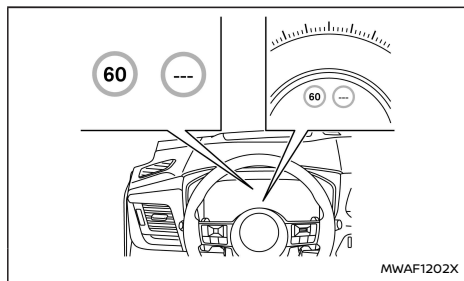
⚠ WARNING

- The TSR system is only intended to be a support device to help provide the driver with information. It is not a replacement for the driver's attention to traffic conditions or responsibility to drive safely. It cannot prevent accidents due to carelessness. It is the driver's responsibility to stay alert and drive safely at all times.
- Any indications and warnings provided by the TSR system will not override the actual speed limit applicable in a particular situation. It is the driver's responsibility to observe and comply with the speed limits at all times.

The TSR system operates as follows:

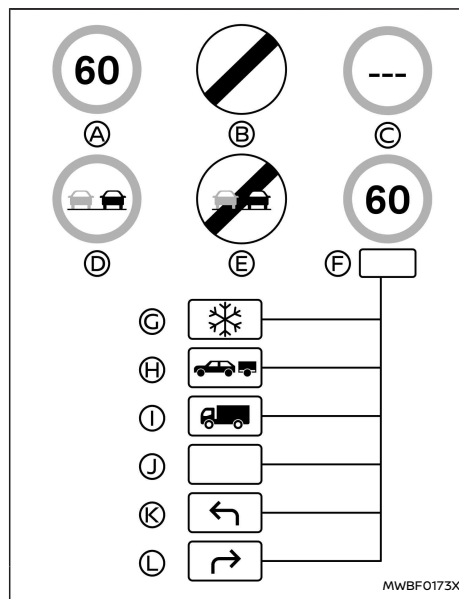
- The function will be automatically turned ON when the power switch is placed in the ON position.
- If the licence of the map data has expired, the map data cannot be used or updated, which means that in some cases the speed limit display cannot be used.
- To maintain the road sign display performance of the system, periodic updates of the map data are required. See "How to update the map data" (P.262).
- The map data may be automatically updated to the latest version depending on the environment and some conditions.

SYSTEM OPERATION



Example

The TSR system displays the following types of road sign:



Available road signs

- (A) Latest detected speed limit
- (B) National speed limit
- (C) No speed limit information
- (D) No-overtaking zone
- (E) End of no-overtaking zone
- (F) Conditional speed limit, with the following available conditions:

- (G) Snow
- (H) Towing
- (I) Goods vehicles
- (J) Generic
- (K) Left turn allowed
- (L) Right turn allowed

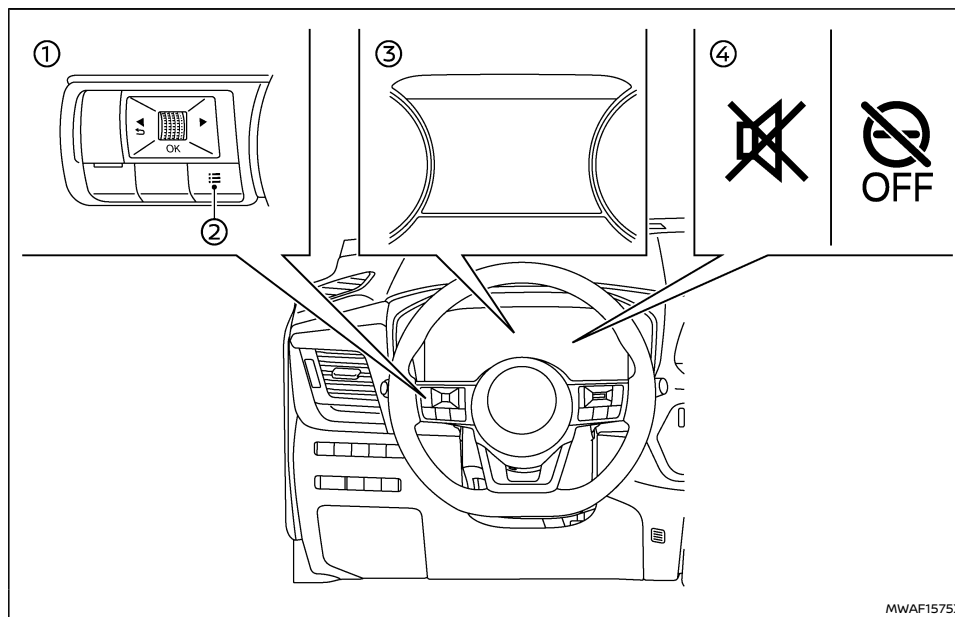
CAUTION

- The TSR system is intended as an aid to careful driving. It is the driver's responsibility to stay alert, drive safely, and observe all road regulations that currently apply, including looking out for road signs.
- The TSR system may not function properly under all conditions. Below are some examples:
 - When the road sign is not clearly visible, for example, due to damage or weather conditions.
 - When rain, snow or dirt adheres to the windscreen in front of the multi-sensing front camera unit.
 - When the headlights are not bright, for example, due to dirt on the lens or if the aiming is not adjusted properly.
 - When strong light enters the camera unit. (For example, the light directly shines on the front of the vehicle at sunrise or sunset.)
 - When a sudden change in brightness occurs. (For example, when the vehicle enters or exits a tunnel or under a bridge.)

- When there is poor visibility. (For example, insufficient illumination of the road, bad weather conditions in rain, snow, fog or heavy spray.)
- When the traffic signs are damaged or not standard. (For example, incorrect size, height, direction or brightness, broken or bent.)
- When the traffic signs are hard to detect. (For example, they are covered by dirt or snow, or insufficient lighting.)
- When the traffic signs are ambiguous. (For example, traffic signs on construction sites, in adjacent lanes or exit lane.)
- When there is an object similar to traffic signs. (For example, similar signs, board or structure.)
- When passing traffic signs are outside the camera's field of vision. (For example, after a sharp turn or located too far away.)
- When electric traffic signs are hard to detect. (For example, low contrast, located too far away or 3 digits.)
- When overtaking buses or trucks with speed stickers.
- The TSR system may display a traffic sign, even though there is no traffic sign in front of the vehicle. It may display a different speed limit from that for a passenger vehicle. (The maximum speed limit sign

may show a higher or lower number than the actual maximum speed, for example, when detecting a speed limit sign for trucks, different speed limit with the time of day or day of the week, or speed limit sign using different units near a border, when detecting an electric traffic sign with or without speed limit indication, when detecting an irrelevant speed limit passing by a freeway exit or junction, etc.)

HOW TO ENABLE/DISABLE THE TSR SYSTEM



MWAFF1575X

- ① Steering-wheel-mounted controls (left side)
- ② Shortcut menu button
- ③ Vehicle information display
- ④ TSR indicators (on the vehicle information display)

Perform the following steps to enable or disable the TSR system, or customise the settings.

Shortcut Menu

1. Push the shortcut menu button on the steering switch to display [Shortcut Menu].

2. Select [Driver Assist Custom] and push the scroll dial to enable the system settings.
3. Select [Custom Mode Setup] and push the scroll dial to customise the settings.

● [Speed Limit]

The TSR system can be customised or turned off.

[Warning]: Both the speed limit information display and overspeed warning function (display and chime) are enabled.

[Info only]: Only the speed limit display is enabled (overspeed alarm sound and flashing display are disabled).

[OFF]: The TSR system is disabled.

● [New Limit Alert]

Notification (chime) when the speed limit changes is enabled or disabled.

Settings

1. Push the ◀ ▶ button until [Settings] appears in the vehicle information display and then push the scroll dial. Use the scroll dial to select [Driver Assistance]. Then push the scroll dial.
2. Select [Traffic Sign Assist] and push the scroll dial.

The following items are available:

● [Speed Limit]

The TSR system can be customised or turned off.

[Warning]: Both the speed limit information display and overspeed warning function (display and chime) are enabled.

[Info only]: Only the speed limit display is enabled (overspeed alarm sound and flashing display are disabled).

[OFF]: The TSR system is disabled.

- [New Limit Alert]
Notification (chime) when the speed limit changes is enabled or disabled.
- [Database Version]
The version of the map data can be confirmed.
- [Update by USB]
This is used to update the map data. (See "How to update the map data" (P.262).)
- [License information]
The map licence information can be confirmed.
[License Expiration]: The expiry date of the map licence
[License state]: The state (active/inactive) of the current map licence

NOTE:

- **When the overspeed warning function is disabled ([Info only] is selected), the "X" indicator appears in the vehicle information display. (The indicator will turn off after a period of time.)**
- **When both the speed limit display and overspeed warning function are disabled ([OFF] is selected), the "OFF" indicator (white) appears in the vehicle information display.**
- **When the power switch is placed in the ON position, the "OFF" indicator (yellow) appears. After starting the e-POWER system,**

the indicator turns off. This indicates the TSR system is operational.

SYSTEM TEMPORARILY UNAVAILABLE

Condition A

If the vehicle is parked in direct sunlight under high temperature conditions (over approximately 40°C (104°F)) and then started, the TSR system may be deactivated automatically. The "OFF" indicator (yellow) and the [Currently Unavailable Front Camera High Temperature] warning message will appear in the vehicle information display.

Action to take:

When the interior temperature is reduced, the TSR system will resume operating automatically.

Condition B

In the following conditions, the "OFF" indicator (yellow) and the [Temporarily Disabled Camera Blocked See Owner's Manual] warning message will appear in the vehicle information display and the system will be turned off automatically.

- The camera area of the windscreen is covered with moisture, snow, ice, dirt or some other object.
- The camera area of the windscreen is continuously covered with dirt, etc.

Action to take:

Check that the windshield is clean and free from ice/mist in front of the camera. If necessary, operate the Max defogging/defrosting function or heated windscreen (where fitted) to clear. This may take several minutes.

When the above conditions no longer exist, the TSR system will resume automatically.

Condition C

If the data communication between systems is temporarily interrupted for some reason, the "OFF" indicator (yellow) and the [Currently Unavailable] warning message will appear in the vehicle information display.

Action to take:

If the warning message appears, pull off the road to a safe location and stop the vehicle. Turn the e-POWER system off and restart the e-POWER system. If the warning message continues to appear, have the TSR system checked. It is recommended you visit a NISSAN dealer or qualified workshop for this service.

SYSTEM MALFUNCTION

If the TSR system malfunctions, it will be turned off automatically, and the "OFF" indicator (yellow) and the [System fault See Owner's Manual] warning message will appear in the vehicle information display.

Action to take

If the warning message appears, pull off the road to a safe location and stop the vehicle. Turn the e-POWER system off and restart the e-POWER system. If the warning message continues to appear, have the system checked. It is recommended you visit a NISSAN dealer or qualified workshop for this service.

SYSTEM MAINTENANCE

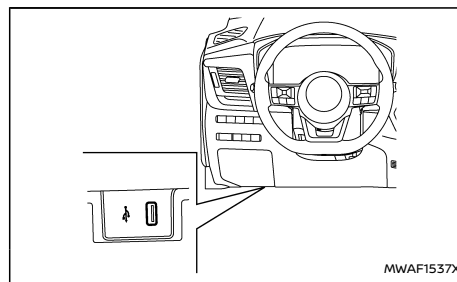
The TSR system uses the same multi-sensing front camera unit that is used by the Emergency Lane Assist (ELA) system, located in front of the inside rearview mirror. For maintenance of the camera, see "System malfunction" (P.269).

How to update the map data

The map data used for the TSR system can be updated by downloading a new map data to a USB memory device and installing it in the vehicle.

For map data update, the following equipments are necessary:

- A USB hub with an external power for connecting the USB memory device to the vehicle
- A USB memory device with a minimum of 8GB storage space
- A personal computer with Internet access to download a new map data
- For detailed specification and recommended products, please contact a NISSAN dealer.



USB port for TSR map update

Perform the following steps to update the map data:

(Visit website or consult a NISSAN dealer or qualified workshop for details.)

1. Confirm the map version* on the vehicle and check if a new version is available at the website. (When the map version on the vehicle and on the website is the same, map update is not necessary.)
 2. If a new version is available, connect the USB hub to the vehicle. Then, save the map information to the USB memory.
 3. Start the e-POWER system.
 4. Download the map data from the website.
 5. Save the map data to the vehicle.
- For details, please visit <https://nissan.navigation.com/nissan-road-database-update>.
 - If you need any assistance for updating the map data, please contact a NISSAN dealer or qualified workshop.

*: The map version can be confirmed as follows:

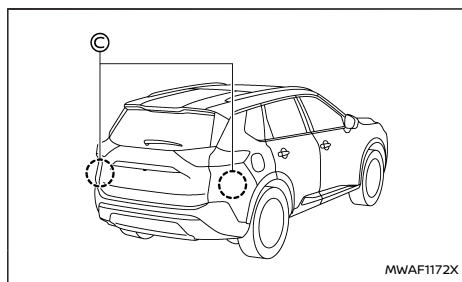
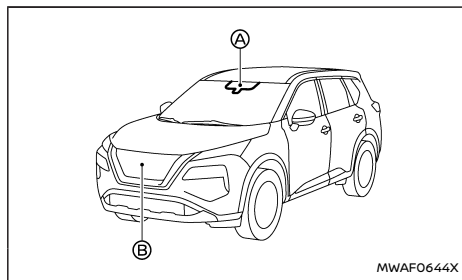
Example: 23.Q1.1

1. First 2 digits: 23 (last 2 digits of the year: 2023)
2. Second 2 digits: Q1 (Quarter 1, from January to March)
3. Last 3 digit(s): 1 (version number, from 1 to 366)

NOTE:

- **The vehicle information display cannot be operated while the map data is being updated.**
- **The map data should be updated while the e-POWER system is running to prevent discharge of the 12-volt battery.**
- **This USB port (for TSR map update) cannot be used for charging an external device.**

EMERGENCY LANE ASSIST (ELA) (where fitted)



⚠ WARNING

Failure to follow the warnings and instructions for proper use of the ELA system could result in serious injury or death.

- The ELA system will not steer the vehicle or prevent loss of control. It is the driver's responsibility to stay alert, drive safely,

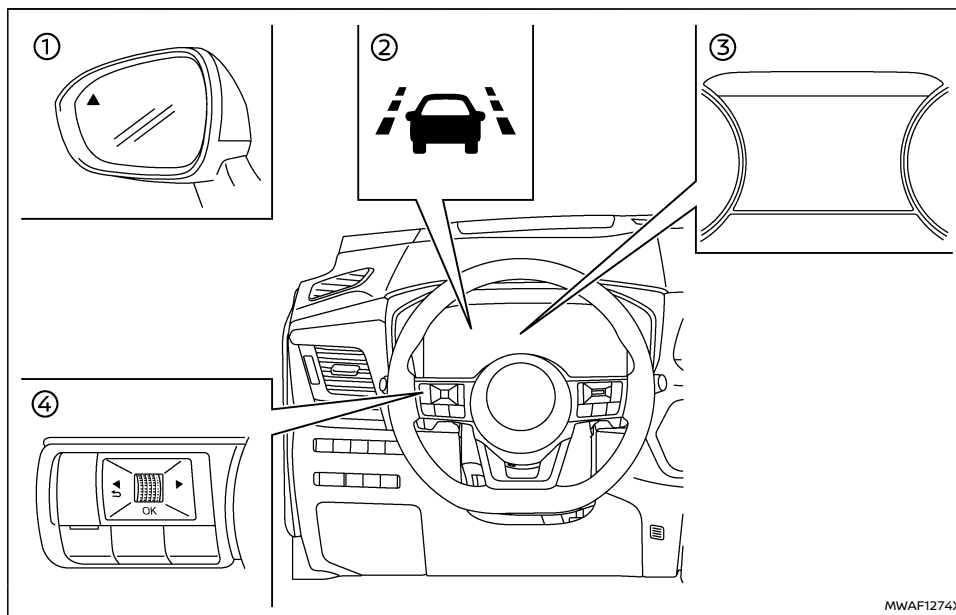
keep the vehicle in the travelling lane, and be in control of the vehicle at all times.

- The ELA system is intended to work on all roads with well defined markings or road edges, but it may not detect the road edge or lane markers in certain road, weather or driving conditions.
- There is a limitation to the detection capability of the sensors. Not every moving object or vehicle will be detected. Always rely on your own operation to avoid accidents.

A part of the ELA system will be automatically turned on each time the e-POWER system is restarted. (See "How to enable/disable the ELA system" (P.265).)

The sensitivity of the ELA system can be adjusted, and this setting is kept until changed again by the driver.

The ELA system uses a multi-sensing front camera **A** located above the inside mirror to monitors the lane markers on the travelling lane and to detect other vehicles. The ELA system also uses radar sensors **B** located at the front of the vehicle and **C** located near the rear bumpers to detect other vehicles.



MWA1274X

- ① Side indicator light
- ② ELA indicator (on the vehicle information display)
- ③ Vehicle information display
- ④ Steering-wheel-mounted controls (left side)

ELA SYSTEM OPERATION

The ELA system will operate when the vehicle is driven at the speeds of approximately 60 km/h (37 MPH) and above, and only when the lane markers or road edge are clearly visible on the road.

The ELA system warns the driver when the vehicle approaches the road edge or lane markers with an indicator on the vehicle information display and

steering wheel vibration. The system helps assist the driver to return the vehicle to the travelling lane by applying the brakes to the left or right wheels individually (for a short period of time) in the following circumstances:

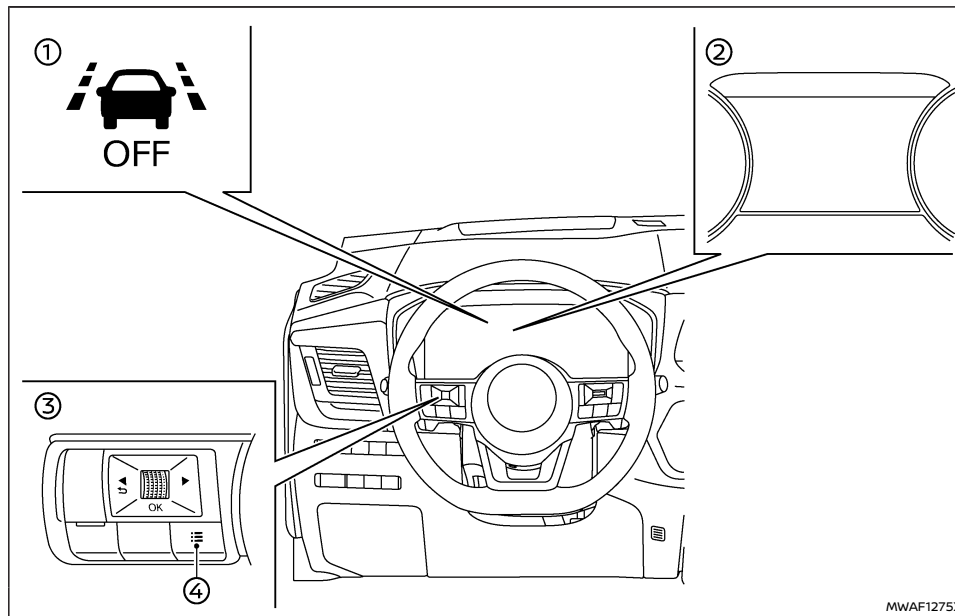
- If [Emergency Lane] is ON in the settings menu of the vehicle information display:
 - the system warns the driver when the vehicle is approaching a lane marker or road edge.
 - the system assists the driver to return the vehicle to the travelling lane when the vehicle is approaching a solid line or road edge, when the oncoming vehicles are in adjacent lanes.
 - the system warns and assists the driver to return the vehicle to the travelling lane when the overtaking vehicles are in adjacent lanes. The side indicator light will also flash.
- If [Advanced Lane] is ON in the settings menu, the system assists the driver to return the vehicle to the travelling lane when the vehicle is approaching a dashed line.

For the selection in the settings menu, see "How to enable/disable the ELA system" (P.265).

During brake control by the ELA system, if the system determines that the steering wheel is not being operated, the duration of the warning buzzer increases as the number of assists increases from the second assist. Even if the system determines that the steering wheel has been operated, the warning buzzer will continue to sound for a certain period of time.

The strength of the steering wheel vibration can be changed in the settings menu of the vehicle information display. (See "Driver Assistance" (P.93).)

HOW TO ENABLE/DISABLE THE ELA SYSTEM



- ① ELA system OFF indicator (on the vehicle information display) ② Vehicle information display
 ③ Steering-wheel-mounted controls (left side)

④ Shortcut menu button

Perform either of the following steps to enable or disable the ELA system.

Shortcut Menu

1. Push the shortcut menu button on the steering wheel switch to display [Shortcut Menu].
2. Select [Driver Assist Custom] and push the scroll dial to enable the system settings.
3. Select [Custom Mode Setup] and push the scroll dial.
4. Select [Emergency Lane] and push the scroll dial to turn the system on or off.

When [Advanced Lane] is selected, a part of the ELA system functions is turned on or off.

Settings

1. Push the ◀ ▶ button until [Settings] appears in the vehicle information display and then push the scroll dial. Use the scroll dial to select [Driver Assistance]. Then push the scroll dial.
2. Select [Lane] and push the scroll dial.
3. Select [Emergency Lane] and push the scroll dial to turn the system on or off.

When [Advanced Lane] is selected, a part of the ELA system functions is turned on or off.

When [Emergency Lane] is turned off, the ELA system OFF indicator illuminates and the ELA system will be turned off.

For details, see "Vehicle information display" (P.92).

NOTE:

- [Emergency Lane] will be automatically turned on each time the e-POWER system is restarted.
- The ON/OFF setting of [Advanced Lane] will be kept even if the e-POWER system is restarted.

Applied road conditions:

- [Emergency Lane]: Lane assist on the road with a solid line or road edge
- [Advanced Lane]: Lane assist on the road with a dashed line

NOTE:

Warning function will be automatically turned on each time the e-POWER system is restarted.

Setting lane sensitivity

You can set lane sensitivity using the [Settings] menu in the vehicle information display.

1. Push the ◀ ▶ button until [Settings] appears in the vehicle information display and then push the scroll dial. Use the scroll dial to select [Driver Assistance]. Then push the scroll dial.
2. Select [Lane] and push the scroll dial.
3. Select [Lane Sensitivity].
 - [Strong]
 - [Normal]
 - [Mild]

NOTE:

The sensitivity setting will be retained even if the e-POWER system is restarted.

Even if the ELA system is disabled in the [Settings] menu, the ELA system will automatically be turned on when the Steering Assist system (where fitted) is active. (After that, when the Steering Assist system stops operating, the ELA system state returns to the state before the Steering Assist system operated.)

ELA SYSTEM LIMITATIONS

WARNING

Listed below are the system limitations for the ELA system. Failure to operate the vehicle in accordance with these system limitations could result in serious injury or death.

- The ELA system may activate if you cross a lane marker or road edge without first activating your turn signal or, for example, if a construction zone directs traffic to cross an existing lane marker. If this occurs you may need to apply corrective steering to complete your lane change.
- Because the ELA system may not activate under the road, weather and lane marker conditions described in this section, it may not activate every time your vehicle begins to leave the travelling lane and you will need to apply corrective steering.
- The ELA system will not operate at speeds below operating speed or if it cannot detect lane markers.

- When the ELA system detects oncoming vehicles in adjacent lanes, the ELA system will not operate at speeds above approximately 120 km/h (74 MPH).
- Do not use the ELA system under the following conditions, there could be serious affect on vehicle safety with risk of an accident and injury or death.
 - When driving without normal tyre conditions (for example, tyre wear, low tyre pressure, installation of other tyre than NISSAN certified standard tyre, tyre chains, non-standard wheels). See “Tyres and Wheels” (P.447).
 - When the vehicle is equipped with non-original brake parts, steering parts or suspension parts.
 - When towing a trailer or other vehicle.
- The ELA system may not function properly in the following conditions:
 - During bad weather (rain, fog, snow, etc.).
 - When driving on slippery roads, such as on ice or snow.
 - When driving on winding or uneven roads.
 - When there is a lane closure due to road repairs.
 - When driving in a makeshift or temporary lane.

- When driving on roads where the lane width is too narrow.
- On roads where there are multiple parallel lane markers; lane markers that are faded or not painted clearly; yellow painted lane markers; non-standard lane markers; or lane markers covered with water, dirt, snow, etc.
- On roads where the edge of the road is not clearly visible.
- On roads where discontinued lane markers are still detectable.
- On roads where there are sharp curves.
- On roads where there are sharply contrasting objects, such as shadows, snow, water, wheel ruts, seams or lines remaining after road repairs. (The ELA system could detect these items as lane markers.)
- On roads where the travelling lane merges or separates.
- When the vehicle's travelling direction does not align with the lane marker.
- When travelling close to the vehicle in front of you, which obstructs the lane camera unit detection range.
- When rain, snow, dirt or object adheres to the windshield in front of the lane camera unit.
- When the headlights are not bright

due to dirt on the lens or if the aiming is not adjusted properly.

- When strong light enters the lane camera unit. (For example, the light directly shines on the front of the vehicle at sunrise or sunset.)
- When a sudden change in brightness occurs. (For example, when the vehicle enters or exits a tunnel or under a bridge.)
- Steering wheel vibration may not be felt depending on the road surface conditions.

Listed below are the system limitations for the overtaking detection feature of the ELA system. Failure to operate the vehicle in accordance with these system limitations could result in serious injury or death.

- The ELA system cannot detect all overtaking vehicles under all conditions.
- The radar sensors may not be able to detect and activate ELA when certain objects are present such as:
 - Pedestrians, bicycles, animals.
 - Vehicles such as motorcycles, low height vehicles, or vehicles with high ground clearance.
 - Vehicles remaining in the detection zone when you accelerate from a stop.
 - A vehicle merging into an adjacent lane at a speed approximately the same as your vehicle.

- A vehicle approaching rapidly from behind.
- A vehicle which your vehicle overtakes rapidly.
- A vehicle that passes through the detection zone quickly.

- The radar sensor's detection zone is designed based on a standard lane width. When driving in a wider lane, the radar sensors may not detect vehicles in an adjacent lane. When driving in a narrow lane, the radar sensors may detect vehicles driving two lanes away.
- The radar sensors are designed to ignore most stationary objects, however objects such as guardrails, walls, foliage and parked vehicles may occasionally be detected. This is a normal operation condition.
- The following conditions may reduce the ability of the radar to detect other vehicles:
 - Severe weather
 - Road spray
 - Ice/frost/dirt build-up on the vehicle
- Do not attach stickers (including transparent material), install accessories or apply additional paint near the radar sensors. These conditions may reduce the ability of the radar to detect other vehicles.

Listed below are the system limitations for the oncoming detection feature of the ELA system. Failure to operate the vehicle in accordance

with these system limitations could result in serious injury or death.

- The ELA system cannot detect all oncoming vehicles under all conditions.
- The following are not detected as oncoming vehicles:
 - Pedestrians, bicycles, animals.
 - Vehicles such as motorcycles, low height vehicles, or vehicles with high ground clearance.
 - Parked vehicles or low speed vehicles.
 - Oncoming vehicles on the same lane.
- The ELA system may not function properly or detect an oncoming vehicle in the following conditions:
 - In poor visibility conditions (such as rain, snow, fog, dust storms, sand storms, smoke and road spray from other vehicles).
 - If dirt, ice, snow, fog or other material is covering the radar sensor area or camera area of the windscreen.
 - If strong light (for example, sunlight or high beams) enters the front camera or a sudden change in brightness occurs (for example, entering a tunnel or driving in lightning).
 - In dark or dimly lit conditions, such as at night or in tunnels, including cases where your vehicle's headlights are off or dim, or the tail lights of the vehicle ahead are off.

- When the direction of the camera is misaligned.
- When driving on a steep downhill slope, on roads with sharp curves, and/or bumpy or dirt roads.
- If there is interference from other radar sources.
- When your vehicle's position or movement is changed quickly or significantly (for example, lane change, turning vehicle, abrupt steering, sudden acceleration or deceleration).
- If the vehicle ahead has a unique or unusual shape, extremely low or high clearance heights, or unusual cargo loading or is narrow (for example, a motorcycle).
- Excessive noise will interfere with the warning chime sound, and the chime may not be heard.

NOTE:

While the ELA system is operating, you may hear a sound of brake operation. This is normal and indicates that the ELA system is operating properly.

SYSTEM TEMPORARILY UNAVAILABLE

Condition A:

The warning and assist functions of the ELA system are not designed to work under the following conditions:

- When you operate the lane change signal and change the travelling lanes in the direction of the signal. (The ELA system will be deactivated for approximately 2 seconds after the lane change signal is turned off). This does not apply if an overtaking vehicle is detected.
- When the vehicle speed lowers to less than operating speed.
- When an oncoming vehicle is detected and the vehicle speed is over approximately 120 km/h (74 MPH).

After the above conditions have finished and the necessary operating conditions are satisfied, the warning and assist functions will resume.

Condition B:

The assist function of the ELA system is not designed to work under the following conditions (warning is still functional):

- When the brake pedal is depressed or if the vehicle decelerates strongly.
- When the steering wheel is turned as far as necessary for the vehicle to change lanes.
- When the vehicle is accelerated during the ELA system operation.
- When the Intelligent Cruise Control (ICC) approach warning occurs (where fitted).

- When the hazard warning flashers are operated.
- When driving on a curve at high speed.
- When the vehicle is making a sharp turn.
- When the Intelligent Emergency Braking with Pedestrian Detection system operates.
- When the ESP system (except Traction Control System (TCS) function) or ABS operates.

After the above conditions have finished and the necessary operating conditions are satisfied, the ELA system application of the brakes will resume.

Condition C:

If the ESP system is turned OFF, the ELA system will be turned off automatically, the [Currently Unavailable ESP OFF] warning message will appear and the ELA indicator (yellow) will illuminate in the vehicle information display.

When the ESP system turns ON again and the necessary operating conditions are satisfied, the ELA system application of the brakes will resume.

Condition D:

If one of the following messages appears and the ELA indicator illuminates in the vehicle information display, the ELA system will be turned off automatically:

- [Temporarily Disabled Side Radar Blocked See Owner's Manual]: When the rear side radar is blocked. Always keep the area near the radar sensors clean.
- [Temporarily Disabled Front Radar Blocked See Owner's Manual]: When the front radar is blocked. Always keep the area near the radar sensor clean.

- [Temporarily Disabled Camera Blocked See Owner's Manual]: When the front camera is blocked. Always keep the area near the front camera clean.
- [Currently Unavailable Front Camera High Temperature]: If the vehicle is parked in direct sunlight under high temperature conditions (over approximately 40°C (104°F)) and then the ELA system is turned on, the ELA system may be deactivated automatically and the ELA indicator illuminates.
- [Currently Not Available]: When the direction of the front camera is significantly misaligned. Have the system checked. It is recommended that you visit a NISSAN dealer or qualified workshop for this service.

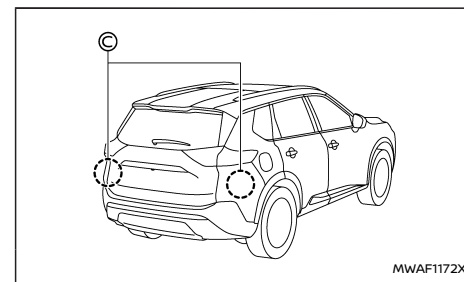
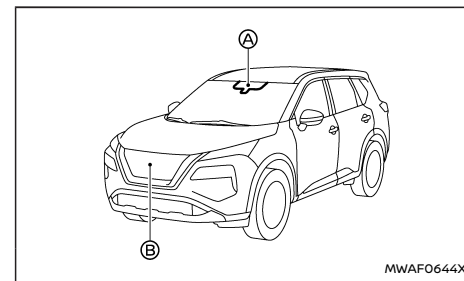
SYSTEM MALFUNCTION

When the ELA system malfunctions, it will cancel automatically. The ELA indicator (yellow) will illuminate, the [System fault See Owner's Manual] warning message will appear in the vehicle information display and a chime will sound.

Action to take

If the warning message appears, pull off the road to a safe and stop the vehicle. Turn the e-POWER system off and restart the e-POWER system. If the warning message continues to appear, have the ELA system checked. It is recommended that you visit a NISSAN dealer or qualified workshop for this service.

SYSTEM MAINTENANCE



The camera (A) is located on the upper side of the windshield. The front radar sensor (B) is located on the front of the vehicle. To keep the ELA system operating properly, be sure to observe the following:

- Always keep the sensor area on the windshield and the front of the vehicle clean.

- Do not strike or damage the areas around the sensors (windscreen, bumper).
- Do not cover or attach stickers or similar objects on the front of the vehicle near the sensor area. This could cause failure or malfunction.
- Do not attach metallic objects near the radar sensor area (brush guard, etc.). This could cause failure or malfunction.
- Do not place reflective materials, such as white paper or a mirror, on the instrument panel. The reflection of sunlight may adversely affect the camera unit's detection capability of detecting lane markers.
- Do not alter, remove or paint the front of the vehicle near the sensor area. Before customising or restoring the sensor area, it is recommended that you visit a NISSAN dealer or qualified workshop.

The two radar sensors © for the ELA system are located near the rear bumper. Always keep the area near the radar sensors clean.

The radar sensors may be blocked by temporary ambient conditions such as snow, splashing water, mist or fog. The blocked condition may also be caused by objects such as ice, frost or dirt obstructing the radar sensors.

Check for and remove objects obstructing the area around the radar sensors.

Do not attach stickers (including transparent material), install accessories or apply additional paint near the radar sensors.

Do not strike or damage the area around the radar sensors.

It is recommended you visit a NISSAN dealer or qualified workshop if the area around the radar sensors is damaged due to a collision.

Precautions on repairing the bumper

When repairing the bumper, take caution because the radar sensors are installed on the bumper.

The radar sensor detects objects by emitting a radar signal and then measuring its reflection.

⚠ WARNING

If an improper repair is performed on the bumper (for example, application of putty made from different materials, repaint, etc.) the radar signal could be weakened or prevented from functioning properly. This may cause the radar sensor not to detect objects correctly. Improper repair may result in serious personal injury. If it is necessary to repair the bumper, it is recommended you visit a NISSAN dealer or qualified workshop for this service.

Radio frequency statement

For the other radio approval numbers and information, see "Radio approval number and information" (P.466).

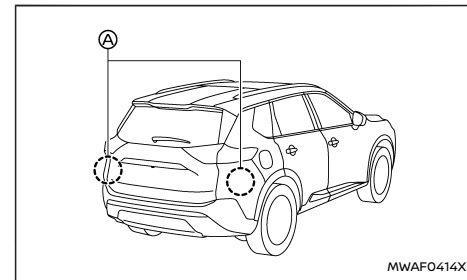
BLIND SPOT WARNING (BSW) (where fitted)

⚠ WARNING

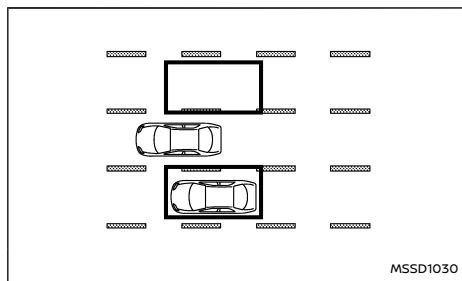
Failure to follow the warnings and instructions for proper use of the BSW system could result in serious injury or death.

- **The BSW system is not a replacement for proper driving procedure and is not designed to prevent contact with vehicles or objects. When changing lanes, always use the side and rear mirrors and turn and look in the direction your vehicle will move to ensure it is safe to change lanes. Never rely solely on the BSW system.**

The BSW system helps alert the driver of other vehicles in adjacent lanes when changing lanes.

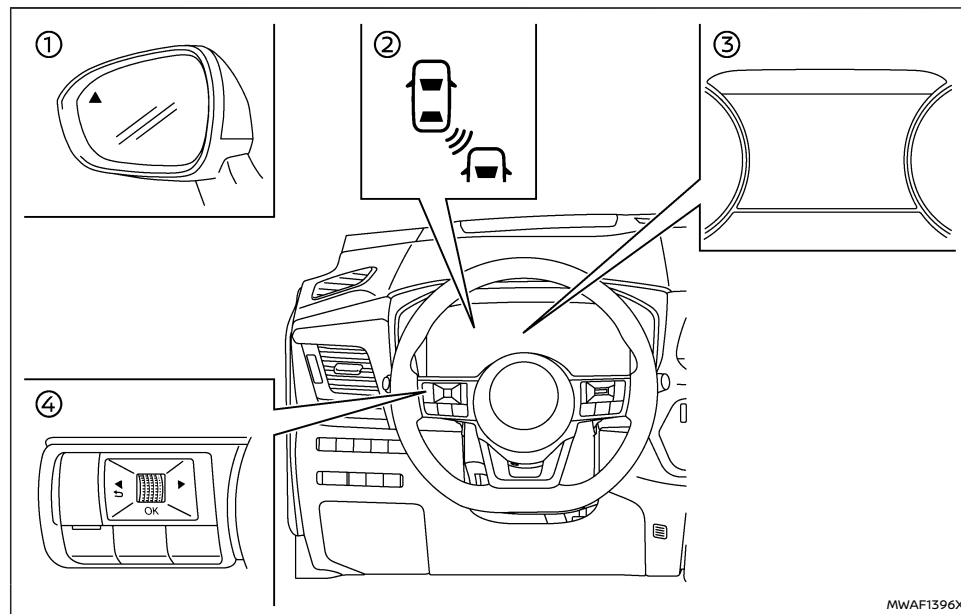


The BSW system uses radar sensors (A) installed near the rear bumper to detect other vehicles in an adjacent lane.



Detection zone

The radar sensors can detect vehicles on either side of your vehicle within the detection zone shown as illustrated. This detection zone starts from the outside rearview mirror of your vehicle and extends approximately 3.0 m (10 ft) behind the rear bumper, and approximately 3.0 m (10 ft) sideways.



- ① Side indicator light
- ② BSW indicator (on the vehicle information display)
- ③ Vehicle information display
- ④ Steering-wheel-mounted controls (left side)

BSW SYSTEM OPERATION

The BSW system operates above approximately 32 km/h (20 MPH).

If the radar sensors detect a vehicle in the detection zone, the side indicator light illuminates.

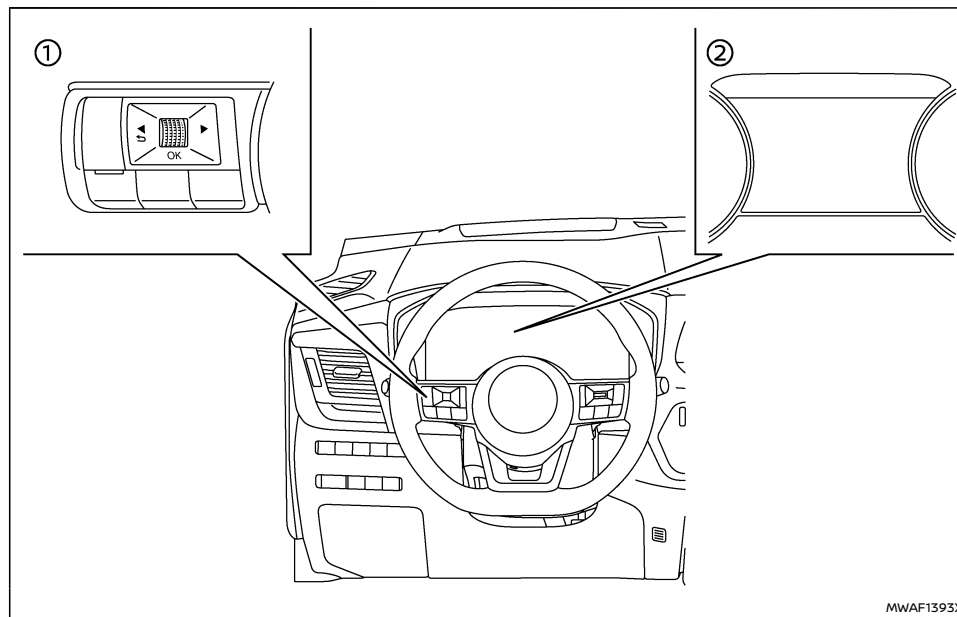
If the turn signal is then activated, the system chimes (twice) and the side indicator light and BSW indicator flash. The side indicator light and BSW

indicator continue to flash until the detected vehicle leaves the detection zone.

The side indicator light illuminates for a few seconds when the power switch is placed in the ON position.

The brightness of the side indicator light is adjusted automatically depending on the brightness of the ambient light.

HOW TO ENABLE/DISABLE THE BSW SYSTEM



- ① Steering-wheel-mounted controls (left side)
- ② Vehicle information display

Perform the following steps to enable or disable the BSW system.

1. Push the ◀ ▶ button until [Settings] appears in the vehicle information display

and then push the scroll dial. Use the scroll dial to select [Driver Assistance]. Then push the scroll dial.

2. Select [Blind Spot] and push the scroll dial.
3. Select [Warning] and push the scroll dial.

NOTE:

The system will retain current settings in the vehicle information display even if the e-POWER system is restarted.

BSW SYSTEM LIMITATIONS**⚠ WARNING**

Listed below are the system limitations for the BSW system. Failure to operate the vehicle in accordance with these system limitations could result in serious injury or death.

- The BSW system cannot detect all vehicles under all conditions.
- The radar sensors may not be able to detect and activate BSW when certain objects are present such as:
 - Pedestrians, bicycles, animals.
 - Vehicles such as motorcycles, low height vehicles, or high ground clearance vehicles.
 - Oncoming vehicles.
 - Vehicles remaining in the detection zone when you accelerate from a stop.
 - A vehicle merging into an adjacent lane at a speed approximately the same as your vehicle.
 - A vehicle approaching rapidly from behind.
 - A vehicle which your vehicle overtakes rapidly.

- A vehicle that passes through the detection zone quickly.
- When overtaking several vehicles in a row, the vehicles after the first vehicle may not be detected if they are travelling close together.

- The radar sensor's detection zone is designed based on a standard lane width. When driving in a wider lane, the radar sensors may not detect vehicles in an adjacent lane. When driving in a narrow lane, the radar sensors may detect vehicles driving two lanes away.
- The radar sensors are designed to ignore most stationary objects, however objects such as guardrails, walls, foliage and parked vehicles may occasionally be detected. This is a normal operation condition.
- The following conditions may reduce the ability of the radar to detect other vehicles:
 - Severe weather
 - Road spray
 - Ice/frost/dirt build-up on the vehicle
- Do not attach stickers (including transparent material), install accessories or apply additional paint near the radar sensors. These conditions may reduce the ability of the radar to detect other vehicles.
- Do not use the BSW system when towing a trailer or other vehicle. The system may not function properly.

- Excessive noise (for example, audio system volume, open vehicle window) will interfere with the chime sound, and it may not be heard.

BSW DRIVING SITUATIONS

Indicator on



Indicator off



Indicator flashing



Another vehicle approaching from behind

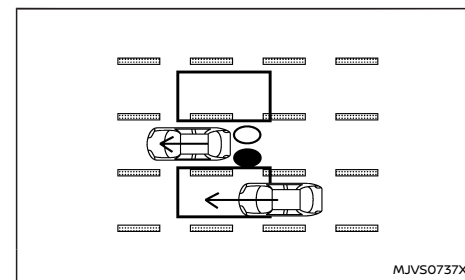
**Illustration 1 - Approaching from behind**

Illustration 1: The side indicator light illuminates if a vehicle enters the detection zone from behind in an adjacent lane.

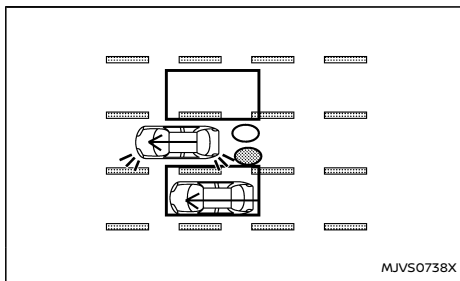


Illustration 2 – Approaching from behind

Illustration 2: If the driver activates the turn signal while another vehicle is in the detection zone, then the system chimes (twice) and the side indicator light and BSW indicator flash.

NOTE:

The radar sensors may not detect vehicles which are approaching rapidly from behind.

Overtaking another vehicle

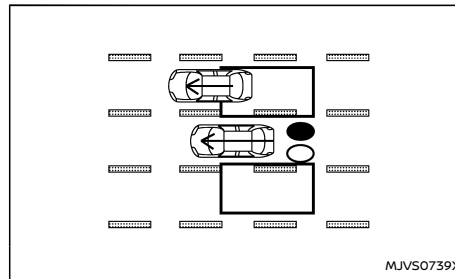


Illustration 3 – Overtaking another vehicle

Illustration 3: The side indicator light illuminates if you overtake a vehicle and that vehicle stays in the detection zone for approximately 2 seconds.

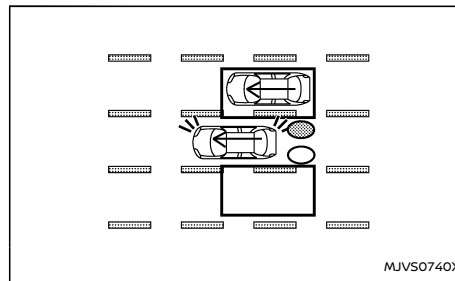


Illustration 4 – Overtaking another vehicle

Illustration 4: If the driver activates the turn signal while another vehicle is in the detection zone, then the system chimes (twice) and the side indicator light and BSW indicator flash.

NOTE:

- When overtaking several vehicles in a row, the vehicles after the first vehicle may not be detected if they are travelling close together.
- The radar sensors may not detect slower moving vehicles if they are passed quickly.
- If the driver activates the turn signal before a vehicle enters the detection zone, the side indicator light and BSW indicator will flash but no chime will sound when the other vehicle is detected.

Entering from the side

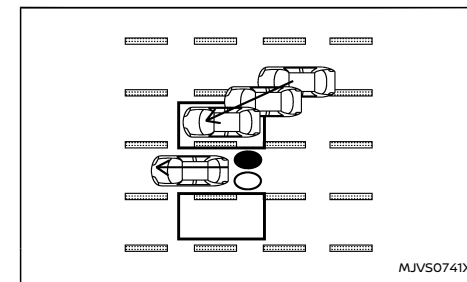


Illustration 5 – Entering from the side

Illustration 5: The side indicator light illuminates if a vehicle enters the detection zone from either side.

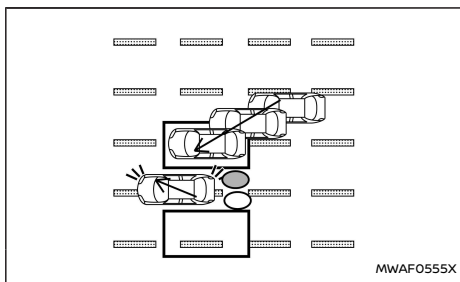


Illustration 6 – Entering from the side

Illustration 6: If the driver activates the turn signal while another vehicle is in the detection zone, then the system chimes (twice) and the side indicator light and BSW indicator flash.

NOTE:

The radar sensors may not detect a vehicle which is travelling at about the same speed as your vehicle when it enters the detection zone.

SYSTEM TEMPORARILY UNAVAILABLE

When radar blockage is detected, the BSW system will be turned off automatically and the [Not available Side radar obstructed] warning message will appear in the vehicle information display.

The system is not available until the conditions no longer exist.

The radar sensors may be blocked by temporary ambient conditions such as splashing water, mist or fog. The blocked condition may also be caused by objects such as ice, frost or dirt obstructing the radar sensors.

NOTE:

If the BSW system stops working, the Intelligent Blind Spot Intervention (where fitted) and the Rear Cross Traffic Alert (RCTA) system will also stop working.

Action to take:

When the above conditions no longer exist, the system will resume automatically.

SYSTEM MALFUNCTION

When the BSW system malfunctions, it will be turned off automatically and the [System fault See Owner's Manual] warning message will appear in the vehicle information display.

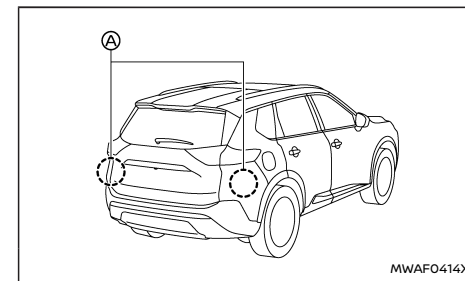
NOTE:

If the BSW system stops working, the Intelligent Blind Spot Intervention (where fitted) and the Rear Cross Traffic Alert (RCTA) system will also stop working.

Action to take:

Stop the vehicle in a safe location, turn the e-POWER system off and restart the e-POWER system. If the message continues to appear, have the BSW system checked. It is recommended that you visit a NISSAN dealer or qualified workshop for this service.

SYSTEM MAINTENANCE



The two radar sensors (A) for the BSW system are located near the rear bumper. Always keep the area near the radar sensors clean.

The radar sensors may be blocked by temporary ambient conditions such as splashing water, mist or fog.

The blocked condition may also be caused by objects such as ice, frost or dirt obstructing the radar sensors.

Check for and remove objects obstructing the area around the radar sensors.

Do not attach stickers (including transparent material), install accessories or apply additional paint near the radar sensors.

Do not strike or damage the area around the radar sensors.

See a NISSAN dealer or qualified workshop or other authorised repair shop if the area around the radar sensors is damaged due to a collision.

INTELLIGENT BLIND SPOT INTERVENTION (where fitted)

Precautions on repairing the bumper

When repairing the bumper, take caution because the radar sensors are installed on the bumper.

The radar sensor detects objects by emitting a radar signal and then measuring its reflection.

⚠ WARNING

If an improper repair is performed on the bumper (for example, application of putty made from different materials, repaint, etc.) the radar signal could be weakened or prevented from functioning properly. This may cause the radar sensor not to detect objects correctly. Improper repair may result in serious personal injury. If it is necessary to repair the bumper, it is recommended you visit a NISSAN dealer or qualified workshop for this service.

Radio frequency statement

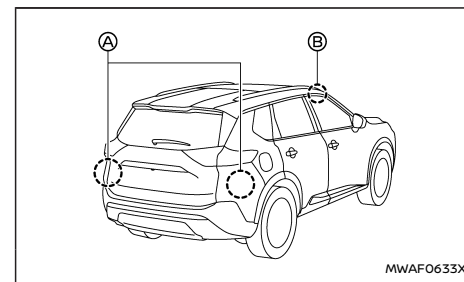
For the other radio approval numbers and information, see "Radio approval number and information" (P.466).

⚠ WARNING

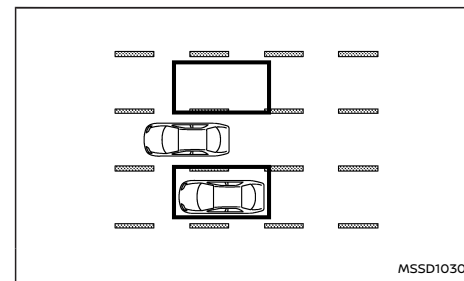
Failure to follow the warnings and instructions for proper use of the Intelligent Blind Spot Intervention system could result in serious injury or death.

- The Intelligent Blind Spot Intervention system is not a replacement for proper driving procedures and is not designed to prevent contact with vehicles or objects. When changing lanes, always use the side and rear mirrors and turn and look in the direction your vehicle will move to ensure it is safe to change lanes. Never rely solely on the Intelligent Blind Spot Intervention system.
- There is a limitation to the detection capability of the radar. Not every moving object or vehicle will be detected. Using the Intelligent Blind Spot Intervention system under some road, ground, lane marker, traffic or weather conditions could lead to improper system operation. Always rely on your own operation to avoid accidents.

The Intelligent Blind Spot Intervention system helps alert the driver of other vehicles in adjacent lanes when changing lanes, and helps assist the driver to return the vehicle to the centre of the travelling lane.



The Intelligent Blind Spot Intervention system uses radar sensors (A) installed near the rear bumper to detect other vehicles in an adjacent lane. In addition to the radar sensors, the Intelligent Blind Spot Intervention system uses a camera (B) installed behind the windscreen to monitor the lane markers of your travelling lane.

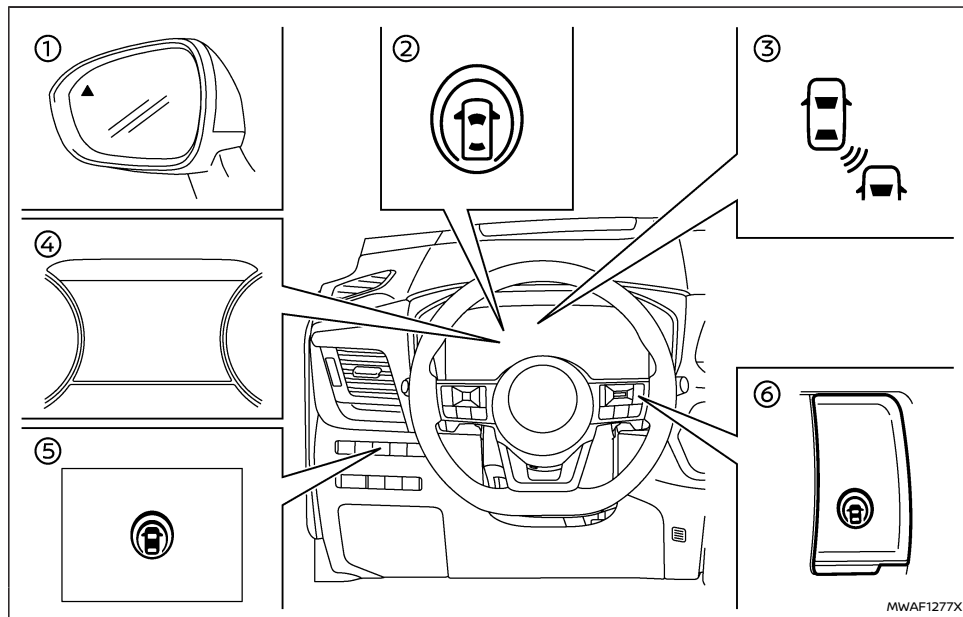


Detection zone

The radar sensors can detect vehicles on either

side of your vehicle within the detection zone shown as illustrated.

This detection zone starts from the outside mirror of your vehicle and extends approximately 3.0 m (10 ft) behind the rear bumper, and approximately 3.0 m (10 ft) sideways.



① Side indicator light

② Intelligent Blind Spot Intervention ON indicator (on the vehicle information display)

- ③ Intelligent Blind Spot Intervention indicator (on the vehicle information display)
- ④ Vehicle information display
- ⑤ Dynamic driver assistance switch (models without ProPILOT Assist system)
- ⑥ ProPILOT Assist switch (models with ProPILOT Assist system)

INTELLIGENT BLIND SPOT INTERVENTION SYSTEM OPERATION

The Intelligent Blind Spot Intervention system operates above approximately 60 km/h (37 MPH).

If the radar sensors detect a vehicle in the detection zone, the side indicator light illuminates.

If the turn signal is then activated, the system chimes (twice) and the side indicator light and Intelligent Blind Spot Intervention indicator flash. The side indicator light and Intelligent Blind Spot Intervention indicator continue to flash until the detected vehicle leaves the detection zone.

If the Intelligent Blind Spot Intervention system is ON and your vehicle approaches a lane marker while another vehicle is in the detection zone, the system chimes (three times) and the side indicator light and Intelligent Blind Spot Intervention indicator flash. The Intelligent Blind Spot Intervention system activates by applying the brakes on one side of the vehicle for a period of time to help return the vehicle back to the centre of the driving lane. The Intelligent Blind Spot Intervention system operates regardless of turn signal usage.

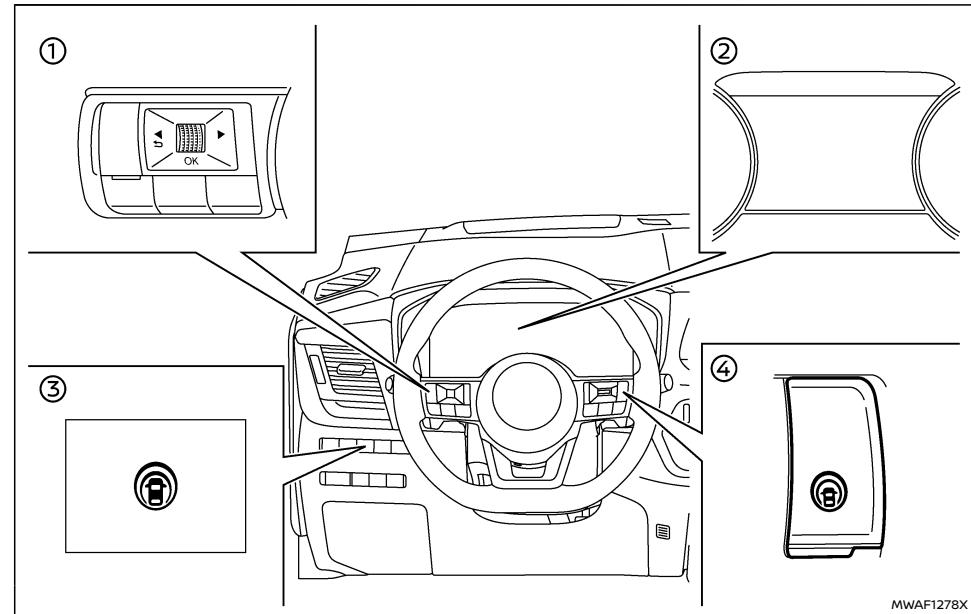
To turn on the Intelligent Blind Spot Intervention system, push the ProPILOT Assist switch on the steering wheel (where fitted) or the dynamic driver assistance switch on the driver's side instrument

panel (where fitted) after starting the e-POWER system. The Intelligent Blind Spot Intervention ON indicator on the vehicle information display will illuminate. Push the ProPILOT Assist switch (where fitted) or the dynamic driver assistance switch (where fitted) again to turn off the Intelligent Blind Spot Intervention system.

NOTE:

Intelligent Blind Spot Intervention warning and system application will only be activated if the side indicator light is already illuminated when your vehicle approaches a lane marker. If another vehicle comes into the detection zone after your vehicle has crossed a lane marker, no Intelligent Blind Spot Intervention warning or system application will be activated. (For additional information, see "Intelligent Blind Spot Intervention driving situations" (P.280).)

HOW TO ENABLE/DISABLE THE INTELLIGENT BLIND SPOT INTERVENTION SYSTEM




- ① Steering-wheel-mounted control (left side)
- ② Vehicle information display
- ③ Dynamic driver assistance switch (models without ProPILOT Assist system)
- ④ ProPILOT Assist switch (models with ProPILOT Assist system)

1. Push the ◀ ▶ button until [Settings] appears in the vehicle information display and then push the scroll dial. Use the scroll dial to select [Driver Assistance]. Then push the scroll dial.

2. Select [Blind Spot] and push the scroll dial.
3. Select [Intervention] and push the scroll dial.
4. Push the ProPILOT Assist switch (where fitted) or the dynamic driver assistance switch (where fitted) to turn the system on or off.

NOTE:

- For model with ProPILOT Assist system: When the Intelligent Blind Spot Intervention system is enabled in the settings menu, the Intelligent Blind Spot Intervention system can be turned on or off by pushing the speed limiter MAIN switch  (where fitted).
- Turning the BSW system off will deactivate the Intelligent Blind Spot Intervention system at the same time.

INTELLIGENT BLIND SPOT INTERVENTION SYSTEM LIMITATIONS

 WARNING

Listed below are the system limitations for the Intelligent Blind Spot Intervention system. Failure to operate the vehicle in accordance with these system limitations could result in serious injury or death.

- The Intelligent Blind Spot Intervention system cannot detect all vehicles under all conditions.
- The radar sensors may not be able to detect and activate the Intelligent Blind Spot Intervention when certain objects are present such as:
 - Pedestrians, bicycles, animals.
 - Vehicles such as motorcycles, low

height vehicles, or high ground clearance vehicles.

- Vehicles remaining in the detection zone when you accelerate from a stop.
- Oncoming vehicles.
- A vehicle merging into an adjacent lane at a speed approximately the same as your vehicle.
- A vehicle approaching rapidly from behind.
- A vehicle which your vehicle overtakes rapidly.
- A vehicle that passes through the detection zone quickly.
- The radar sensor's detection zone is designed based on a standard lane width. When driving in a wider lane, the radar sensors may not detect vehicles in an adjacent lane. When driving in a narrow lane, the radar sensors may detect vehicles driving two lanes away.
- The radar sensors are designed to ignore most stationary objects, however objects such as guardrails, walls, foliage and parked vehicles may occasionally be detected. This is a normal operation condition.
- The following conditions may reduce the ability of the radar to detect other vehicles:
 - Severe weather
 - Road spray
 - Ice/frost/dirt build-up on the vehicle

- Do not attach stickers (including transparent material), install accessories or apply additional paint near the radar sensors. These conditions may reduce the ability of the radar to detect other vehicles.
- The camera may not detect lane markers in the following situations and the Intelligent Blind Spot Intervention system may not operate properly.
 - On roads where there are multiple parallel lane markers; lane markers that are faded or not painted clearly; yellow painted lane markers; nonstandard lane markers; lane markers covered with water, dirt, snow, etc.
 - On roads where discontinued lane markers are still detectable.
 - On roads where there are sharp curves.
 - On roads where there are sharply contrasting objects, such as shadows, snow, water, wheel ruts, seams or lines remaining after road repairs.
 - On roads where the travelling lane merges or separates.
 - When the vehicle's travelling direction does not align with the lane markers.
 - When travelling close to the vehicle in front of you, which obstructs the lane camera unit detection range.
 - When rain, snow or dirt adheres to the windscreen in front of a lane camera unit.

- When the headlights are not bright due to dirt on the lens or if aiming is not adjusted properly.
- When strong light enters a lane camera unit. (For example: light directly shines on the front of the vehicle at sunrise or sunset.)
- When a sudden change in brightness occurs. (For example: when the vehicle enters or exits a tunnel or under a bridge.)
- Do not use the Intelligent Blind Spot Intervention system under the following conditions because the system may not function properly.
 - During bad weather. (For example: rain, fog, snow, etc.)
 - When driving on slippery roads, such as on ice or snow, etc.
 - When driving on winding or uneven roads.
 - When there is a lane closure due to road repairs.
 - When driving in a makeshift or temporary lane.
 - When driving on roads where the lane width is too narrow.
 - When driving with a tyre that is not within normal tyre conditions (for example, tyre wear, low tyre pressure, installation of other tyre than NISSAN

certified standard tyre, tyre chains, non-standard wheels).

- When the vehicle is equipped with non-original brake parts, steering parts or suspension parts.
- When towing a trailer or other vehicle.
- Excessive noise (for example, audio system volume, open vehicle window) will interfere with the chime sound, and it may not be heard.

INTELLIGENT BLIND SPOT INTERVENTION DRIVING SITUATIONS

Indicator on



Indicator off



Indicator flashing



Another vehicle approaching from behind

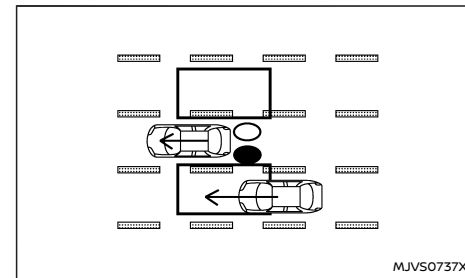


Illustration 1 – Approaching from behind

Illustration 1: The side indicator light illuminates if a vehicle enters the detection zone from behind in an adjacent lane.

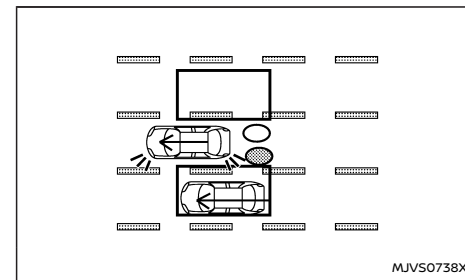


Illustration 2 – Approaching from behind

Illustration 2: If the driver activates the turn signal then the system chimes a sound (twice) and the side indicator light and Intelligent Blind Spot Intervention indicator flash.

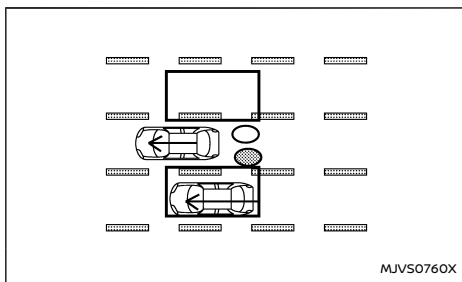


Illustration 3 - Approaching from behind

Illustration 3: If the Intelligent Blind Spot Intervention system is on and your vehicle approaches a lane marker while another vehicle is in the detection zone, the system chimes (three times) and the side indicator light and Intelligent Blind Spot Intervention indicator flash. The Intelligent Blind Spot Intervention system activates by applying the brakes on one side of the vehicle for a short period of time to help return the vehicle back to the centre of the driving lane.

NOTE:

The radar sensors may not detect vehicles which are approaching rapidly from behind.

Overtaking another vehicle

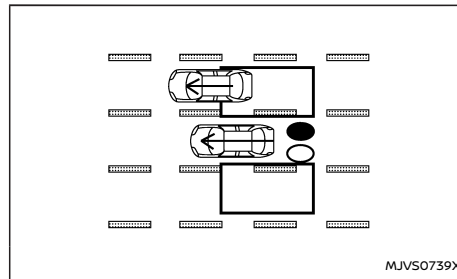


Illustration 4 - Overtaking another vehicle

Illustration 4: The side indicator light illuminates if you overtake a vehicle and that vehicle stays in the detection zone for approximately 3 seconds.

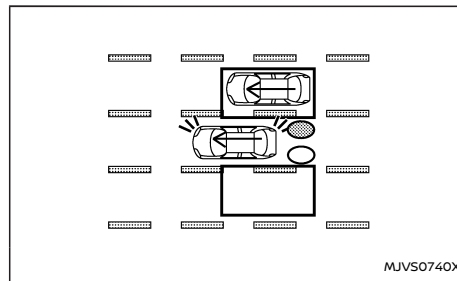


Illustration 5 - Overtaking another vehicle

Illustration 5: If the driver activates the turn signal while another vehicle is in the detection zone, then the system chimes (twice) and the side indicator

light and Intelligent Blind Spot Intervention indicator flash.

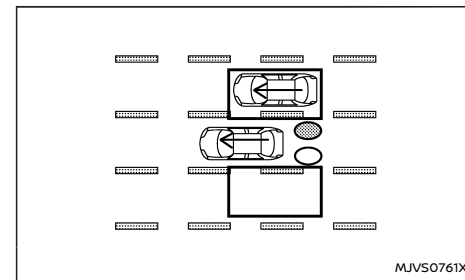


Illustration 6 - Overtaking another vehicle

Illustration 6: If the Intelligent Blind Spot Intervention system is on and your vehicle approaches a lane marker while another vehicle is in the detection zone, the system chimes (three times) and the side indicator light and Intelligent Blind Spot Intervention indicator flash. The Intelligent Blind Spot Intervention system activates to by applying the brakes on one side of the vehicle for a short period of time to help return the vehicle back to the centre of the driving lane.

NOTE:

- **When overtaking several vehicles in a row, the vehicles after the first vehicle may not be detected if they are travelling close together.**
- **The radar sensors may not detect slower moving vehicles if they are passed quickly.**

Entering from the side

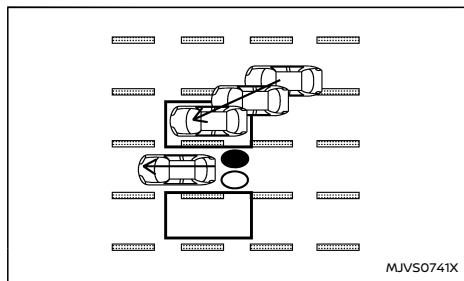


Illustration 7 - Entering from the side

Illustration 7: The side indicator light illuminates if a vehicle enters the detection zone from either side.

NOTE:

The radar sensors may not detect a vehicle which is travelling at about the same speed as your vehicle when it enters the detection zone.

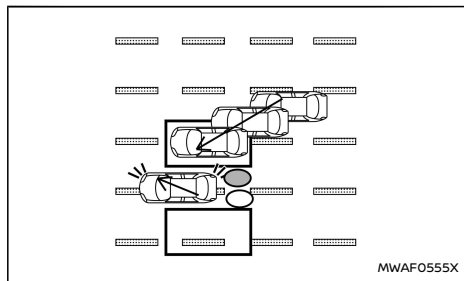


Illustration 8 - Entering from the side

Illustration 8: If the driver activates the turn signal while another vehicle is in the detection zone, then the side indicator light and Intelligent Blind Spot Intervention indicator flash and a chime will sound twice.

NOTE:

If the driver activates the turn signal before a vehicle enters the detection zone, the side indicator light and Intelligent Blind Spot Intervention indicator will flash but no chime will sound when another vehicle is detected.

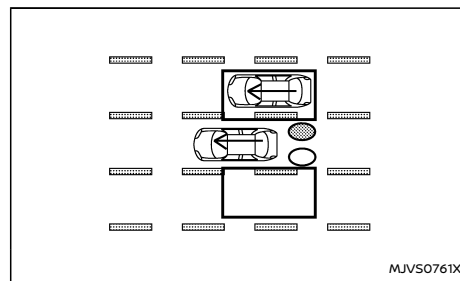


Illustration 9 - Entering from the side

Illustration 9: If the Intelligent Blind Spot Intervention system is on and your vehicle approaches the lane marker while another vehicle is in the detection zone, the system chimes (three times) and the side indicator light and Intelligent Blind Spot Intervention indicator flash. The Intelligent Blind Spot Intervention system activates by applying the brakes on one side of the vehicle for a short period of time to help return the vehicle back to the centre of the driving lane.

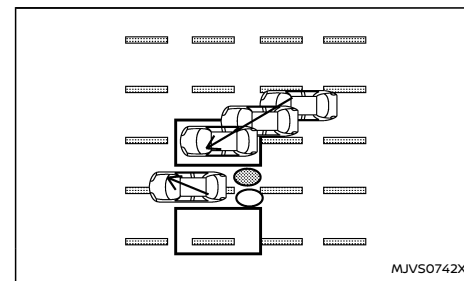


Illustration 10 - Entering from the side

Illustration 10: The Intelligent Blind Spot Intervention system will not operate if your vehicle is on a lane marker when another vehicle enters the detection zone. In this case only the BSW system operates.

NOTE:

- The radar sensors may not detect a vehicle which is travelling at about the same speed as your vehicle when it enters the detection zone.
- The Intelligent Blind Spot Intervention will not operate or will stop operating and only a warning chime will sound under the following conditions.
 - When the brake pedal is depressed or if the vehicle decelerates strongly.
 - When the vehicle is accelerated during the Intelligent Blind Spot Intervention system operation

- When steering quickly
- When the ICC, Intelligent Forward Collision Warning or Intelligent Emergency Braking with Pedestrian Detection warnings sound.
- When the hazard warning flashers are operated.
- When driving on a curve at a high speed.
- When the BSW system is turned off.

SYSTEM TEMPORARILY UNAVAILABLE

When any of the following messages appear on the vehicle information display, a chime will sound and the Intelligent Blind Spot Intervention system will be turned off automatically.

- [Unavailable Slippery Road]:
When the ESP system (except traction control system function) or ABS operates.
- [Currently Not Available]:
 - When the ESP system is turned off.
 - When the SNOW mode or the OFF-ROAD mode is selected (4WD models).
- [Unavailable Camera Temperature High]:
If the vehicle is parked in direct sunlight under high temperature conditions (over approximately 40°C (104°F)).
- [Not available Side radar obstructed]:
When side radar blockage is detected.

Turn off the Intelligent Blind Spot Intervention system and turn it on again when the above conditions no longer exist.

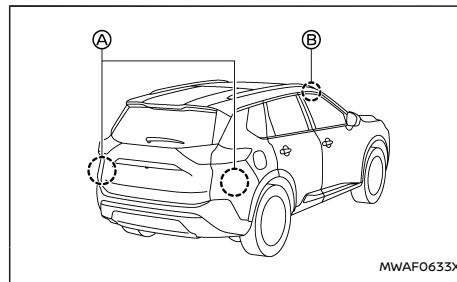
SYSTEM MALFUNCTION

When the Intelligent Blind Spot Intervention system malfunctions, it will be turned off automatically, the Intelligent Blind Spot Intervention indicator illuminates and a chime will sound, and the [System fault See Owner's Manual] warning message will appear in the vehicle information display.

Action to take:

Stop the vehicle in a safe location and push the P position switch to engage the P (Park) position. Turn the e-POWER system off and restart the e-POWER system. If the warning message continues to appear, it is recommended you visit a NISSAN dealer or qualified workshop for this service.

SYSTEM MAINTENANCE



The two radar sensors **A** for the Intelligent Blind Spot Intervention system are located near the rear bumper. Always keep the area near the radar sensors clean.

The radar sensors may be blocked by temporary ambient conditions such as splashing water, mist or fog.

The blocked condition may also be caused by objects such as ice, frost or dirt obstructing the radar sensors.

Check for and remove objects obstructing the area around the radar sensors.

Do not attach stickers (including transparent material), install accessories or apply additional paint near the radar sensors.

Do not strike or damage the area around the radar sensors.

It is recommended you visit a NISSAN dealer or qualified workshop if the area around the radar sensors is damaged due to a collision.

The lane camera unit **B** for the Intelligent Blind Spot Intervention system is located above the inside mirror. To keep the proper operation of the Intelligent Blind Spot Intervention and prevent a system malfunction, be sure to observe the following:

- Always keep the windscreen clean.
- Do not attach a sticker (including transparent material) or install an accessory near the camera unit.
- Do not place reflective materials, such as white paper or a mirror, on the instrument panel. The reflection of sunlight may adversely affect the camera unit's capability of detecting the lane markers.

REAR CROSS TRAFFIC ALERT (RCTA) (where fitted)

- Do not strike or damage the areas around the camera unit. Do not touch the camera lens or remove the screw located on the camera unit. It is recommended you contact a NISSAN dealer or qualified workshop if the camera unit is damaged due to an accident.

Precautions on repairing the bumper

When repairing the bumper, take caution because the radar sensors are installed on the bumper.

The radar sensor detects objects by emitting a radar signal and then measuring its reflection.

WARNING

If an improper repair is performed on the bumper (for example, application of putty made from different materials, repaint, etc.) the radar signal could be weakened or prevented from functioning properly. This may cause the radar sensor not to detect objects correctly. Improper repair may result in serious personal injury. If it is necessary to repair the bumper, it is recommended you visit a NISSAN dealer or qualified workshop for this service.

Radio frequency statement

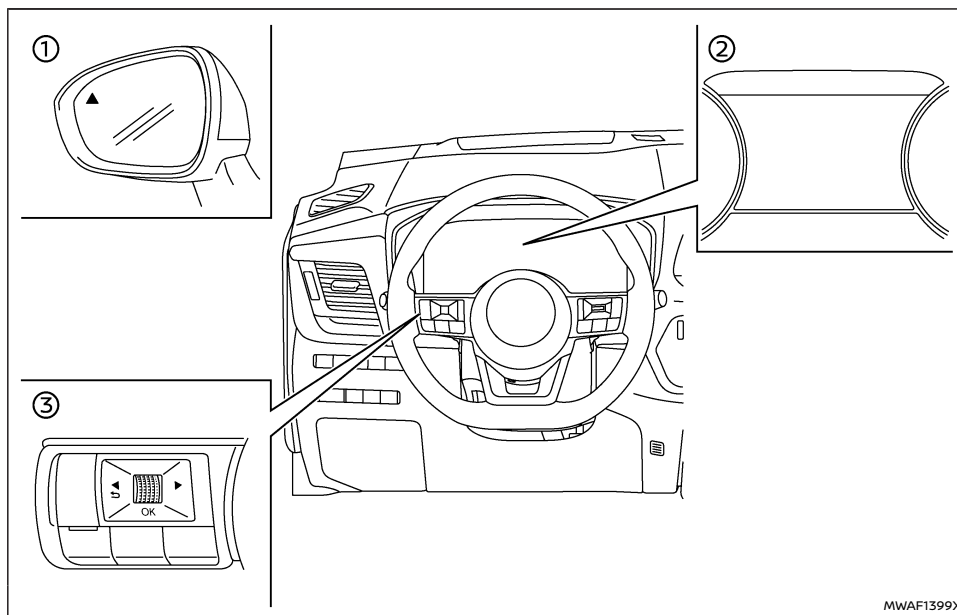
For the other radio approval numbers and information, see "Radio approval number and information" (P.466).

WARNING

Failure to follow the warnings and instructions for proper use of the RCTA system could result in serious injury or death.

- **The RCTA system is not a replacement for proper driving procedures and is not designed to prevent contact with vehicles or objects. When reversing out of a parking space, always use the side and rear mirrors and turn and look in the direction your vehicle will move. Never rely solely on the RCTA system.**

The RCTA system will assist you when reversing out from a parking space. When the vehicle is in reverse, the system is designed to detect other vehicles approaching from the right or left of the vehicle. If the system detects cross traffic, it will alert you.



MWAFF1399X

- ① Side indicator light
- ② Vehicle information display
- ③ Steering-wheel-mounted controls (left side)

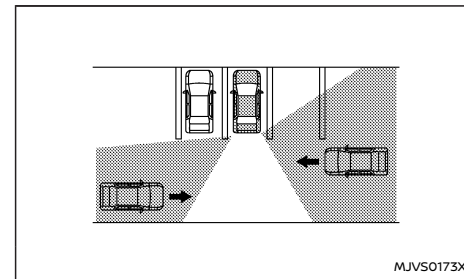
RCTA SYSTEM OPERATION

The RCTA system can help alert the driver of an approaching vehicle when the driver is reversing out of a parking space.

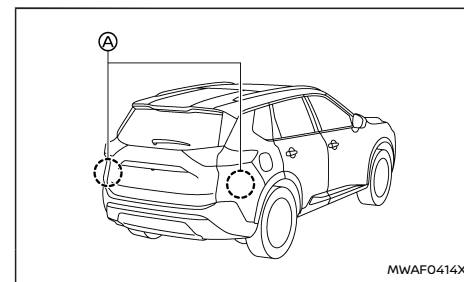
When the shift position is in R (Reverse) and the vehicle speed is less than approximately 8 km/h (5 MPH), the RCTA system is operational.

If the radar detects an approaching vehicle from

either side, the system chimes (once) and the side indicator light flashes on the side the vehicle is approaching from.



MJVS0173X

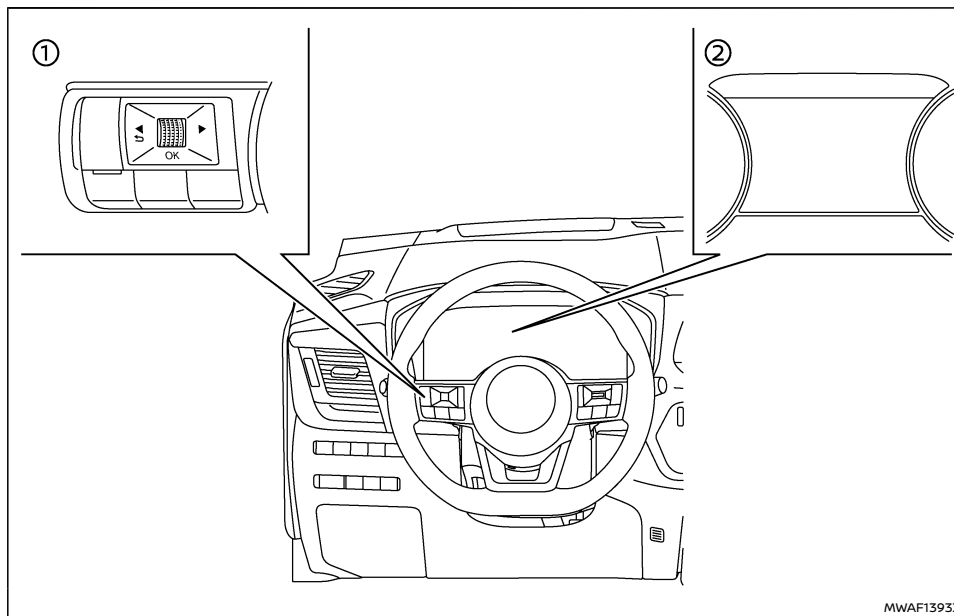


MWAFF0414X

The RCTA system uses radar sensors (A) installed on both sides near the rear bumper to detect an approaching vehicle.

The radar sensors can detect an approaching vehicle from up to approximately 20 m (66 ft) away.

HOW TO ENABLE/DISABLE THE RCTA SYSTEM



NOTE:

The system setting will be retained even if the e-POWER system is restarted.

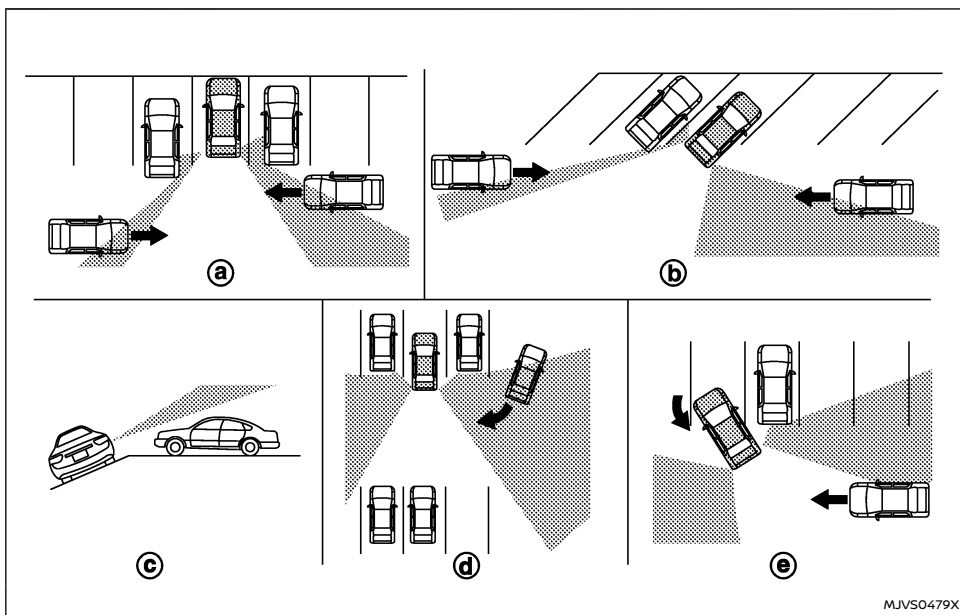
- ① Steering-wheel-mounted controls (left side)
- ② Vehicle information display

Perform the following steps to enable or disable the RCTA system.

1. Push the ◀ ▶ button until [Settings] appears in the vehicle information display

and then push the scroll dial. Use the scroll dial to select [Driver Assistance]. Then push the scroll dial.

2. Select [Rear Cross Traffic Alert] and push the scroll dial to turn the system on or off.



RCTA SYSTEM LIMITATIONS

⚠ WARNING

Listed below are the system limitations for the RCTA system. Failure to operate the vehicle in accordance with these system limitations could result in serious injury or death.

- Always check surroundings and turn to

check what is behind you before reversing. The radar sensors detect approaching (moving) vehicles. The radar sensors cannot detect every object such as:

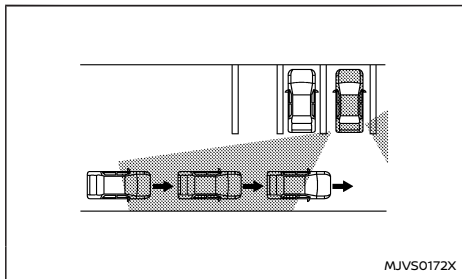
- Pedestrians, bicycles, motorcycles, animals or child-operated toy vehicles
- A vehicle that is passing at speeds

greater than approximately 30 km/h (19 MPH)

- A vehicle that is passing at speeds lower than approximately 8 km/h (5 MPH)
- The radar sensors may not detect approaching vehicles in certain situations:
 - Illustration (a): When a vehicle parked next to you obstructs the beam of the radar sensor.
 - Illustration (b): When the vehicle is parked in an angled parking space.
 - Illustration (c): When the vehicle is parked on inclined ground.
 - Illustration (d): When an approaching vehicle turns into your vehicle's parking lot aisle.
 - Illustration (e): When the angle formed by your vehicle and approaching vehicle is small.
- The following conditions may reduce the ability of the radar to detect other vehicles:
 - Severe weather
 - Road spray
 - Ice/frost/dirt build-up on the vehicle
- Do not attach stickers (including transparent material), install accessories or apply additional paint near the radar sensors. These conditions may reduce the ability of the radar to detect other vehicles
- When towing a trailer or other vehicle, turn

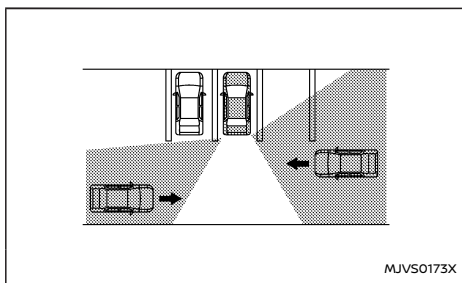
the RCTA system off to prevent the occurrence of an unexpected accident resulting from sudden system operation.

- Excessive noise (e.g. audio system volume, open vehicle window) will interfere with the chime sound, and it may not be heard.



MJVS0172X

Illustration 1



MJVS0173X

Illustration 2

NOTE:

In the case of several vehicles approaching in a row (Illustration 1) or in the opposite direction (Illustration 2), a chime may not be sounded by the RCTA system after the first vehicle passes the sensors.

SYSTEM TEMPORARILY UNAVAILABLE

When radar blockage is detected, the system will be deactivated automatically. The [Not available Side radar obstructed] warning message will appear in the vehicle information display.

The systems are not available until the conditions no longer exist.

The radar sensors may be blocked by temporary ambient conditions such as splashing water, mist or fog.

The blocked condition may also be caused by objects such as ice, frost or dirt obstructing the radar sensors.

NOTE:

If the BSW system stops working, the RCTA and the Intelligent Blind Spot Intervention (where fitted) systems will also stop working.

Action to take:

When the above conditions no longer exist, the system will resume automatically.

SYSTEM MALFUNCTION

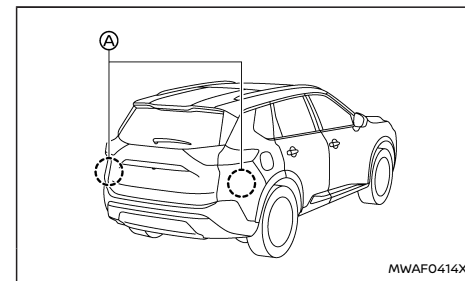
When the RCTA system malfunctions, it will be turned off automatically. The [System fault See Owner's Manual] warning message will appear in the vehicle information display.

NOTE:


If the BSW system stops working, the RCTA and the Intelligent Blind Spot Intervention (where fitted) systems will also stop working.

Action to take:

Stop the vehicle in a safe location and push the P position switch to engage the P (Park) position. Turn the e-POWER system off and restart the e-POWER system. If the warning message continues to appear, have the system checked. It is recommended you visit a NISSAN dealer or qualified workshop for this service.

SYSTEM MAINTENANCE

MWAFO414X

The two radar sensors  for the RCTA system are located near the rear bumper. Always keep the area near the radar sensors clean.

The radar sensors may be blocked by temporary ambient conditions such as splashing water, mist or fog.

The blocked condition may also be caused by objects such as ice, frost or dirt obstructing the radar sensors.

Check for and remove objects obstructing the area around the radar sensors.

Do not attach stickers (including transparent material), install accessories or apply additional paint near the radar sensors.

Do not strike or damage the area around the radar sensors. It is recommended that you visit a NISSAN dealer or qualified workshop if the area around the radar sensors is damaged due to a collision.

Precautions on repairing the bumper

When repairing the bumper, take caution because the radar sensors are installed on the bumper.

The radar sensor detects objects by emitting a radar signal and then measuring its reflection.

WARNING

If an improper repair is performed on the bumper (for example, application of putty made from different materials, repaint, etc.) the radar signal could be weakened or prevented from functioning properly. This may cause the radar sensor not to detect objects correctly. Improper repair may result in serious personal injury. If it is necessary to repair the

bumper, it is recommended you visit a NISSAN dealer or qualified workshop for this service.

Radio frequency statement

For the other radio approval numbers and information, see "Radio approval number and information" (P.466).

SPEED LIMITER (where fitted)

The speed limiter allows you to set the desired vehicle speed limit. While the speed limiter is activated, the driver can perform normal braking and acceleration, but the vehicle will not exceed the set speed.

WARNING

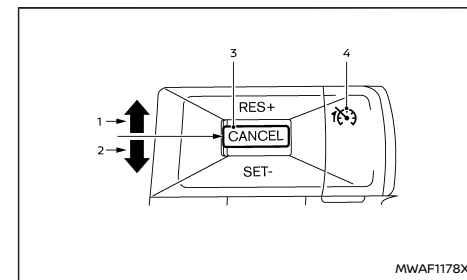
- Always observe posted speed limits. Do not set the speed over them.
- Always confirm the setting status of the speed limiter on the vehicle information display.

When the speed limiter is on, the cruise control (where fitted) system cannot be operated.

SPEED LIMITER OPERATIONS

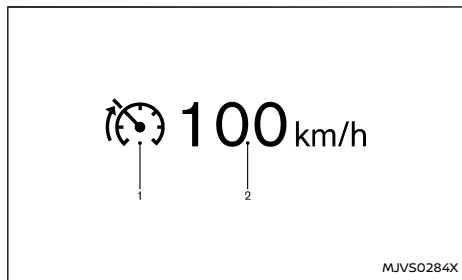
The speed limiter can be set at a speed between the following speeds.

- 30 to 170 km/h (20 to 105 MPH) (for 2WD models)
- 30 to 180 km/h (20 to 110 MPH) (for 4WD models)



The speed limiter set switches are located on the steering wheel.

1. RES+ operation
2. SET- operation
3. <CANCEL> switch
4. Speed limiter MAIN switch (When this switch is pushed, the speed limiter enters the standby mode. If the cruise control (where fitted) or ICC system (where fitted) is on, the system will turn off and the speed limiter enters the standby mode.)



The speed limiter operating condition is shown on the vehicle information display.

1. Speed limiter indicator
2. Set speed indicator

The speed unit can be converted between [km/h] and [MPH] (where fitted). (See "Unit/Language" (P.100).)

When the vehicle speed exceeds the set speed limit, the set speed indicator blinks and the

accelerator pedal operation will not work until the vehicle speed slows down to the set speed limit.

The speed limiter will not automatically reduce the vehicle speed to the set speed limit.

Turning on speed limiter

Push the speed limiter MAIN switch. The speed limiter and the set speed indicators illuminate on the vehicle information display ([LIMIT ON Press SET- to Activate] message appears on the display).

Setting speed limit

1. Push down the <CANCEL> switch to SET-.
 - When the vehicle is stopped, the speed will be set at 30 km/h or 20 MPH.
 - While driving, the speed limit will be set at the current speed.

NOTE:

If you push up the <CANCEL> switch to RES+ and release it when there is no vehicle set speed, the vehicle will behave the same way as when the <CANCEL> switch is pushed down to SET-.

2. When the speed limit is set, the speed limiter indicator and the set speed indicator illuminate on the vehicle information display ([+/- Change Set Speed] message appears on the display).

Changing set speed limit:

Use either of the following operations to change the speed limit.

- Push and hold the <CANCEL> switch to RES+ or SET-. The set speed will increase or decrease by approximately 5 km/h or 5 MPH.
- Push, then quickly release the <CANCEL> switch to RES+ or SET-. Each time you do this, the set speed will increase or decrease by approximately 1 km/h or 1 MPH.

The new set speed limit value will be displayed in the vehicle information display.

When the actual vehicle speed exceeds the set speed, an audible warning will be heard a short time after the set speed is exceeded if driver intervention is not detected.

Cancelling speed limit

To cancel the speed limiter, push the <CANCEL> switch. The speed limiter indicator and the set speed indicator on the vehicle information display will turn off ([Standby Press RES+ to Resume] message appears on the display).

It is also possible to override the speed limiter by fully depressing the accelerator pedal beyond the resistance point.

⚠ WARNING

- **The vehicle may accelerate when the speed limiter cancels.**
- **When additional floor mats are used, be sure that they are correctly secured and that they cannot interfere with the accelerator pedal. Mats not adapted to the vehicle may prevent proper operation of the speed limiter.**

Fully depress the accelerator pedal beyond the resistance point. The speed limiter will be suspended to allow driving above the set speed. The set speed indicator will flash. The speed limiter will automatically resume when the vehicle speed drops below the set speed limit.

Resuming a previous set speed

If a set speed limit has been cancelled, the set speed will be stored in the speed limiter memory. This speed limit can be reactivated by pushing up the **<CANCEL>** switch to RES+ ([Resumed] message appears on the display).

If the current vehicle speed is higher than the previous set speed, the accelerator pedal will not work and the set speed indicator will flash until the vehicle speed drops below the set speed limit.

When the actual vehicle speed exceeds the set speed, an audible warning will be heard a short time after the set speed is exceeded and driver intervention is not detected.

Turning the speed limiter off

The speed limiter system will be turned off when one of the following operations is performed:

- Push the speed limiter MAIN switch. The speed limiter indicator and the set speed indicator on the vehicle information display will be turned off.
- Push the Cruise ON/OFF switch. The speed limiter information on the vehicle information will be replaced with the cruise control information. For details, see "Cruise control (where fitted)" (P.291).

- When the vehicle is stopped and the power switch is placed in the OFF position.

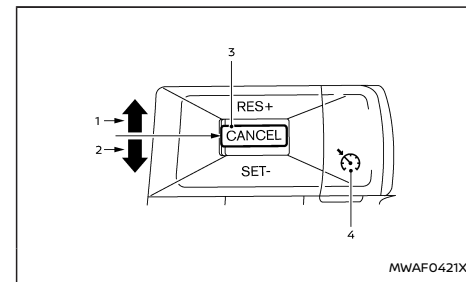
Turning off the speed limiter will erase the set speed limit memory.

Speed limiter malfunction

If the speed limiter malfunctions, the speed limiter on the vehicle information display will flash ([LIMIT Not Available] message appears on the display).

Turn the speed limiter MAIN switch off and have the system checked by a certified NISSAN dealer or qualified workshop.

CRUISE CONTROL (where fitted)



1. RES+ operation
2. SET- operation
3. **<CANCEL>** switch
4. Cruise ON/OFF switch

For models with the ProPILOT Assist system, see "Conventional (fixed speed) cruise control mode" (P.336).

For models with the Intelligent Cruise Control (ICC) system (without ProPILOT Assist system), see "Conventional (fixed speed) cruise control mode" (P.306).

⚠ WARNING

- **Always observe the posted speed limits and do not set the speed over them.**
- **Do not use the cruise control when driving under the following conditions. Doing so could cause a loss of vehicle control and result in an accident.**
 - When it is not possible to keep the vehicle at a constant speed

- When driving in heavy traffic
- When driving in traffic that varies speed
- When driving in windy areas
- When driving on winding or hilly roads
- When driving on slippery (rain, snow, ice, etc.) roads

PRECAUTIONS ON CRUISE CONTROL

- If the cruise control system malfunctions, it will cancel automatically. The cruise indicator in the vehicle information display will then blink to warn the driver.
- If the cruise indicator blinks and [Not Available Cruise System Fault] message appears in the display, turn the Cruise ON/OFF switch off and have the system checked. It is recommended that you visit a NISSAN dealer or qualified workshop for this service.
- The cruise indicator may blink when the Cruise ON/OFF switch is turned ON while pushing up the <CANCEL> switch to RES+, pushing down the <CANCEL> switch to SET-, or pushing the <CANCEL> switch. To properly set the cruise control system, perform the following procedures.

CRUISE CONTROL OPERATIONS

The cruise control allows driving at speeds above 30 km/h (20 MPH) without keeping your foot on the accelerator pedal.

The cruise control will automatically be cancelled if the vehicle slows down more than approximately 13 km/h (8 MPH) below the vehicle set speed. ([Not Available Speed Too High/Low] message appears in the display.)

Moving the shift lever to the N (Neutral) position will cancel the cruise control.

Turning on cruise control

Push the Cruise ON/OFF switch. The cruise indicator and [CRUISE ON Press SET- to Activate] message in the vehicle information display will appear.

Setting cruising speed

1. Accelerate to the desired speed.
2. Push down the <CANCEL> switch to SET- or push up the <CANCEL> switch to RES+ and release it.
3. Take your foot off the accelerator pedal.

The vehicle will maintain the set speed. ([+ /- Change Set Speed] message appears in the display.)

NOTE:

If pushed up the <CANCEL> switch to RES+ and released it when there is no vehicle set speed, the set speed is set to the current vehicle speed.

Passing another vehicle:

Depress the accelerator pedal to accelerate. After releasing the accelerator pedal, the vehicle will return to the previously set speed.

The vehicle may not maintain the set speed when going up or down steep hills. In such cases, drive without the cruise control.

Resetting to slower speed:

Use any one of the following methods to reset to a slower speed.

- Lightly tap the footbrake pedal. When the vehicle reaches the desired speed, push down the <CANCEL> switch to SET- and release it.
- Push down and hold the <CANCEL> switch to SET-. This will reduce the vehicle speed by about 1 km/h or 1 MPH, or 5 km/h or 5 MPH depending on the model. When the vehicle reaches the desired speed, release the <CANCEL> switch.
- Quickly push down the <CANCEL> switch to SET- and release it. This will reduce the vehicle speed by about 1 km/h or 1 MPH.

Resetting to faster speed:

Use any one of the following methods to reset to a faster speed.

- Depress the accelerator pedal. When the vehicle reaches the desired speed, push down the <CANCEL> switch to SET- and release it.
- Push up and hold the <CANCEL> switch to RES+. This will increase the vehicle speed by about 5 km/h or 5 MPH. When the vehicle reaches the desired speed, release the <CANCEL> switch.

INTELLIGENT CRUISE CONTROL (ICC) (where fitted)

- Quickly push up the **<CANCEL>** switch to RES+ and release it. This will increase the vehicle speed by about 1 km/h or 1 MPH.

Resuming at preset speed:

Push up the **<CANCEL>** switch to RES+ and release it.

The vehicle will resume the last set cruising speed when the vehicle speed is over 30 km/h (20 MPH). ([Resumed] message appears in the display.)

Cancelling cruising speed

Use any one of the following methods to cancel the vehicle set speed. ([Standby Press RES+ to Resume] message appears in the display.)

- Push the **<CANCEL>** switch.
- Tap the footbrake pedal.
- Push the Cruise ON/OFF switch. The cruise indicator will turn off.

For models with the ProPILOT Assist system, see "Intelligent Cruise Control (ICC)" (P.319).

WARNING

Failure to follow the warnings and instructions for proper use of the ICC system could result in serious injury or death.

- **ICC is not a collision avoidance or warning device. It is intended for highway use only and it is not intended for congested areas or city driving. Failure to apply the brakes could result in an accident.**
- **The ICC system is only an aid to assist the driver and is not a collision warning or avoidance device. It is the driver's responsibility to stay alert, drive safely, and be in control of the vehicle at all times.**
- **Always observe posted speed limits and do not set the speed over them.**
- **Always drive carefully and attentively when using either cruise control mode. Read and understand the Owner's Manual thoroughly before using the cruise control. To avoid serious injury or death, do not rely on the system to prevent accidents or to control the vehicle's speed in emergency situations. Do not use cruise control except in appropriate road and traffic conditions.**
- **In the conventional (fixed speed) cruise control mode, a warning chime will not sound to warn you if you are too close to the vehicle ahead. Pay special attention to the distance between your vehicle and the**

vehicle ahead of you or a collision could occur.

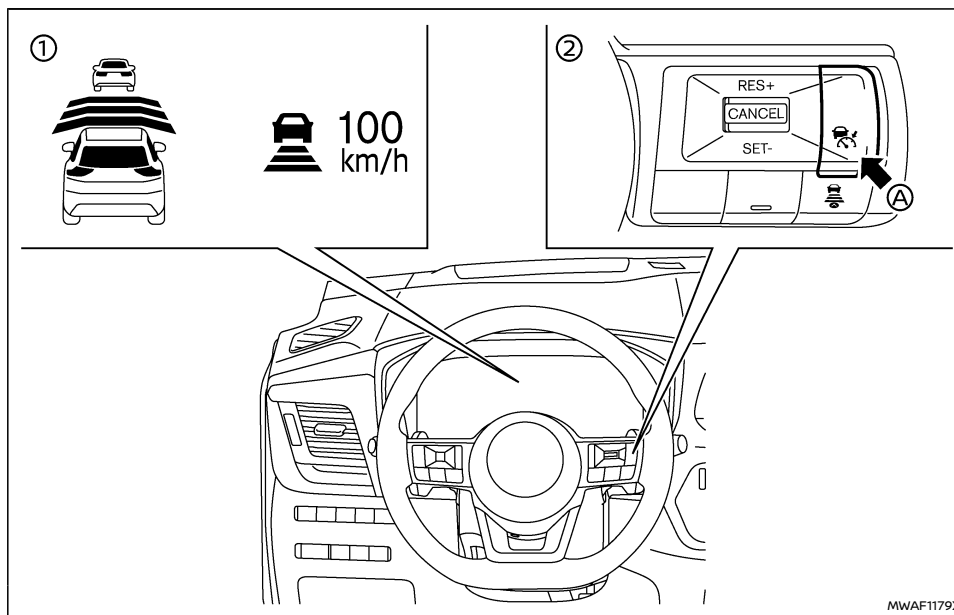
The ICC system will maintain a constant set speed or keep a set distance from the vehicle in front of you up to the preset speed.

The vehicle travels at a set speed when the road ahead is clear.

The ICC system can be set to one of two cruise control modes.

- **Vehicle-to-vehicle distance control mode:**
For maintaining a selected distance between your vehicle and the vehicle in front of you up to the preset speed.
- **Conventional (fixed speed) cruise control mode:**
For cruising at a preset speed.

The ICC system cannot be operated when the speed limiter is on. (See "Speed limiter (where fitted)" (P.289).)



Example

- ① Displays and indicators
- ② ICC switches
- Ⓐ Cruise ON/OFF switch

Push the Cruise ON/OFF switch Ⓐ to choose the cruise control mode between the vehicle-to-vehicle distance control mode and the conventional (fixed speed) cruise control mode.

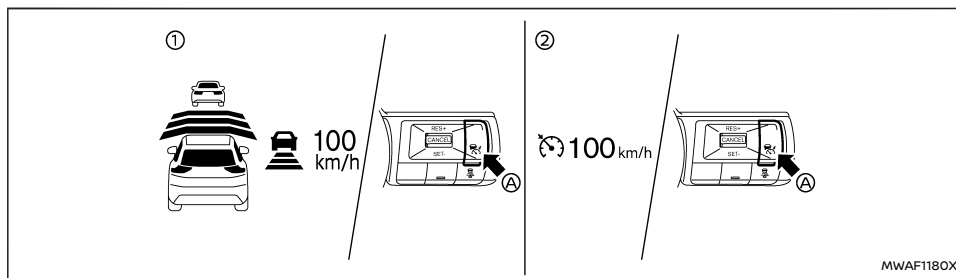
Once a control mode is activated, it cannot be changed to the other cruise control mode. To change the mode, push the Cruise ON/OFF switch Ⓐ once to turn the system off. Then push the Cruise ON/OFF switch Ⓐ again to turn the system back on and select the desired cruise control mode.

Always confirm the setting in the ICC system display.

For the vehicle-to-vehicle distance control mode, see "Vehicle-to-vehicle distance control mode" (P.295).

For the conventional (fixed speed) cruise control mode, see "Conventional (fixed speed) cruise control mode" (P.306).

HOW TO SELECT THE CRUISE CONTROL MODE



Example

Selecting the vehicle-to-vehicle distance control mode

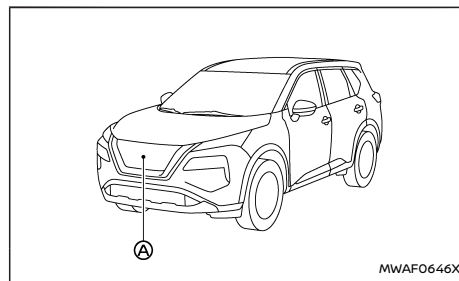
To choose the vehicle-to-vehicle distance control mode ①, quickly push and release the Cruise ON/OFF switch (A).

Selecting the conventional (fixed speed) cruise control mode

To choose the conventional (fixed speed) cruise control mode ②, push and hold the Cruise ON/OFF switch (A) for longer than approximately 1.5 seconds. See "Conventional (fixed speed) cruise control mode" (P.306).

VEHICLE-TO-VEHICLE DISTANCE CONTROL MODE

In the vehicle-to-vehicle distance control mode, the ICC system automatically maintains a selected distance from the vehicle travelling in front of you according to that vehicle's speed (up to the set speed), or at the set speed when the road ahead is clear.



The system is intended to enhance the operation of the vehicle when following a vehicle travelling in the same lane and direction.

If the radar sensor (A) detects a slower moving vehicle ahead, the system will reduce the vehicle speed so that your vehicle follows the vehicle in front at the selected distance.

The system automatically controls the throttle and applies the brakes (up to approximately 40% of vehicle braking power) if necessary.

Vehicle-to-vehicle distance control mode operation

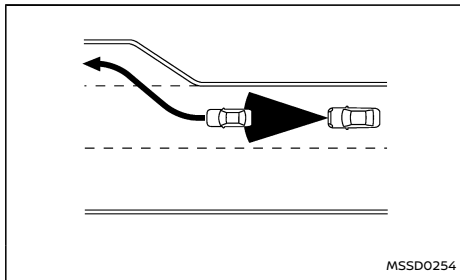
The vehicle-to-vehicle distance control mode is designed to maintain a selected distance and reduce the speed to match the slower vehicle ahead; the system will decelerate the vehicle as necessary. However, the ICC system can only apply up to approximately 40% of the vehicle's total braking power. This system should only be used when traffic conditions allow vehicle speeds to remain fairly constant or when vehicle speeds change gradually. If a vehicle moves into the travelling lane ahead or if a vehicle travelling ahead rapidly decelerates, the distance between vehicles may become closer because the ICC system cannot decelerate the vehicle quickly enough. If this occurs, the ICC system will sound a warning chime and blink the system display to notify the driver to take necessary action.

The system will cancel and a warning chime will sound if the speed is below approximately 25 km/h (15 MPH) and a vehicle is not detected ahead.

The following items are controlled in the vehicle-to-vehicle distance control mode:

- When there are no vehicles travelling ahead, the vehicle-to-vehicle distance control mode maintains the speed set by the driver. The set speed range is above approximately 30 km/h (20 MPH).
- When there is a vehicle travelling ahead, the vehicle-to-vehicle distance control mode adjusts the speed to maintain the distance, selected by driver, from the vehicle ahead. The adjusting speed range is between approximately 30 km/h (20 MPH) and up to the set speed.
- When the vehicle travelling ahead has moved out from its lane of travel, the vehicle-to-vehicle distance control mode accelerates and maintains vehicle speed up to the set speed.

The ICC system does not control vehicle speed or warn you when you approach stationary and slow moving vehicles. You must pay attention to vehicle operation to maintain proper distance from vehicles ahead when approaching toll gates or traffic congestion.

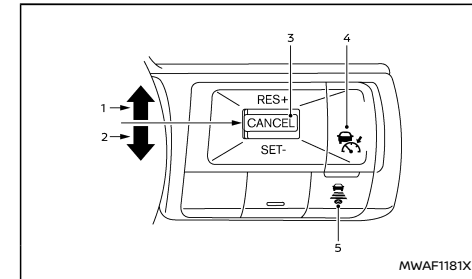


When driving on the freeway at a set speed and approaching a slower travelling vehicle ahead, the ICC system will adjust the speed to maintain the distance, selected by the driver, from the vehicle ahead. If the vehicle ahead changes lanes or exits the freeway, the ICC system will accelerate and maintain the speed up to the set speed. Pay attention to the driving operation to maintain control of the vehicle as it accelerates to the set speed.

The vehicle may not maintain the set speed on winding or hilly roads. If this occurs, you will have to manually control the vehicle speed.

Normally when controlling the distance to a vehicle ahead, this system automatically accelerates or decelerates your vehicle according to the speed of the vehicle ahead. Depress the accelerator to properly accelerate your vehicle when acceleration is required for a lane change. Depress the brake pedal when deceleration is required to maintain a safe distance to the vehicle ahead due to its sudden braking or if a vehicle cuts in. Always stay alert when using the ICC system.

Vehicle-to-vehicle distance control mode switches

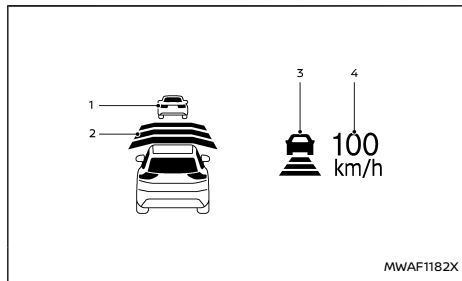


The system is operated by the Cruise ON/OFF switch and four control switches, all mounted on the steering wheel.

1. **RES+ operation:**
Resumes set speed or increases speed incrementally.
2. **SET- operation:**
Sets desired cruise speed, reduces speed incrementally.
3. **<CANCEL> switch:**
Deactivates the system without erasing the set speed.
4. **Cruise ON/OFF switch:**
Master switch to activate the system
5. **DISTANCE switch:**
Changes the vehicle's following distance:

- [Far]
- [Middle]
- [Near]

Vehicle-to-vehicle distance control mode display and indicators



Example

The display is located on the left side of the speedometer.

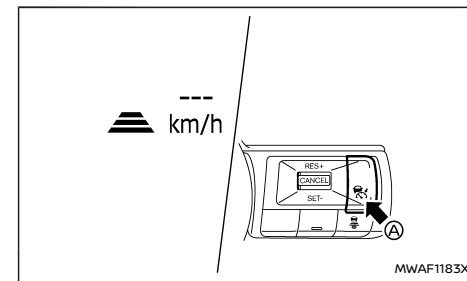
1. Vehicle ahead detection indicator:
Indicates whether it detects a vehicle in front of you (only when ICC is active).
2. Set distance indicator:
Displays the selected distance between vehicles set with the DISTANCE switch.
3. This indicator indicates the ICC system status using colour.
 - ICC system ON indicator (green):
ICC standby.

- ICC system ON indicator (green):
Indicates that the ICC system is ON and active.
Indicates that the cruising speed is set.
 - Green vehicle icon displayed: Vehicle detected ahead.
 - No vehicle icon shown: No vehicle detected ahead. (Your vehicle maintains the driver-selected set speed.)
- ICC system warning (yellow):
Indicates that there is a malfunction in the ICC system.

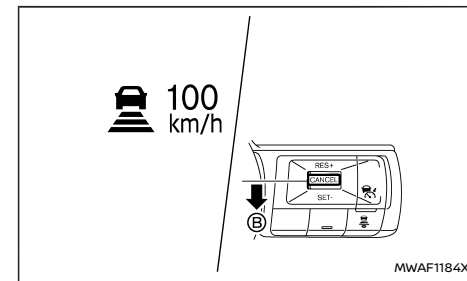
4. Set vehicle speed indicator:
Indicates the set vehicle speed.

- Green: ICC active
 - Grey: ICC standby
- (The speed unit can be converted between [km/h] and [MPH] (where fitted). See "Unit/Language" (P.100).)


Operating vehicle-to-vehicle distance control mode




To turn on the cruise control, quickly push and release the Cruise ON/OFF switch (A). The ICC system ON indicator (grey), set distance indicator and set vehicle speed indicator come on and in a standby state for setting.




To set cruising speed, accelerate your vehicle to the desired speed, push down the <CANCEL>

switch to SET-  and release it. (The ICC system ON indicator (green), set distance indicator and set vehicle speed indicator come on.) Take your foot off the accelerator pedal. Your vehicle will maintain the set speed.

When the **<CANCEL>** switch is pushed to SET-  under the following conditions, the system cannot be set and the set vehicle speed indicator will blink for approximately 2 seconds:

- When travelling below 30 km/h (20 MPH) and the vehicle ahead is not detected
- When the shift lever is not in the D (Drive) position
- When the parking brake is applied
- When the brakes are operated by the driver

When the **<CANCEL>** switch is pushed to SET-  under the following conditions, the system cannot be set and a message will pop up.

- When the ESP system is off. (To use the ICC system, turn on the ESP system. Push the Cruise ON/OFF switch to turn off the ICC system and reset the ICC system by pushing the Cruise ON/OFF switch again.)

For additional information about the ESP system, see "Electronic Stability Programme (ESP) system" (P.372).

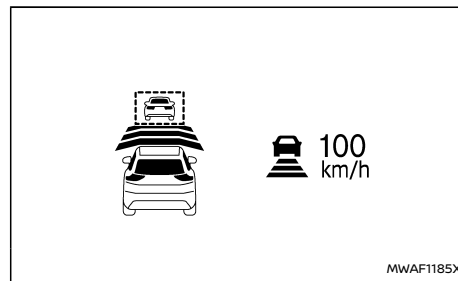
- When ESP (including the traction control system) is operating.
- When the [SNOW] mode or [OFF-ROAD] mode is selected. (4WD models)
- When a wheel is slipping. (To use the ICC system, make sure the wheels are no longer slipping.)

- When the front radar is impaired due to dirt or an other obstruction blocking the radar sensor.

The driver sets the desired vehicle speed based on the road conditions. The ICC system maintains the set vehicle speed, similar to standard cruise control, as long as no vehicle is detected in the lane ahead.

The ICC system displays the set speed.

Vehicle detected ahead:



Example

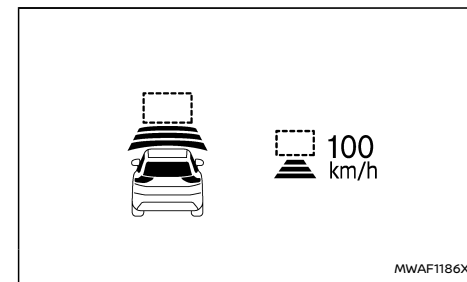
When a vehicle is detected in the lane ahead, the ICC system decelerates the vehicle by controlling the throttle and applying the brakes to match the speed of a slower vehicle ahead. The system then controls the vehicle speed based on the speed of the vehicle ahead to maintain the driver selected distance.

NOTE:

- **The brake lights of the vehicle come on when brake lights is performed by the ICC system.**
- **When the brake operates, a noise may be heard. This is not a malfunction.**

When a vehicle ahead is detected, the vehicle ahead detection indicator comes on. The ICC system will also display the set speed and selected distance.

Vehicle ahead not detected:



Example

When a vehicle is no longer detected ahead, the ICC system gradually accelerates your vehicle to resume the previously set vehicle speed. The ICC system then maintains the set speed.

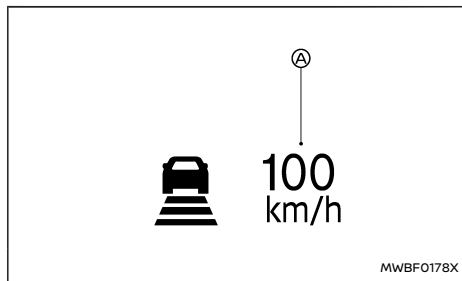
When a vehicle is no longer detected the vehicle ahead detection indicator turns off.

If a vehicle ahead appears during acceleration to the set vehicle speed or any time the ICC system is

in operation, the system controls the distance to that vehicle.

When a vehicle is no longer detected under approximately 25 km/h (15 MPH), the system will be cancelled.

When passing another vehicle:



The driver can override ICC by depressing the accelerator pedal. The set speed indicator **A** will flash when the vehicle speed exceeds the set speed. The vehicle detect indicator will turn off when the area ahead of the vehicle is open. When the pedal is released, the vehicle will return to the previously set speed.

Even though your vehicle speed is set in the ICC system, you can depress the accelerator pedal when it is necessary to accelerate your vehicle rapidly.

How to switch the ICC system off

Switch off the ICC system completely by turning the Cruise ON/OFF switch off. The ICC indicators will go out.

How to change the set vehicle speed

To cancel the preset speed, use any of these methods:

- Push the **<CANCEL>** switch. The set vehicle speed indicator and the cruise indicator will turn grey.
- Tap the brake pedal. The set vehicle speed indicator and the cruise indicator will turn grey.
- Turn the Cruise ON/OFF switch off. The ICC indicators will go out.

To reset at a faster cruising speed, use one of the following methods:

- Depress the accelerator pedal. When the vehicle attains the desired speed, push down the **<CANCEL>** switch to SET- and release it.
- Push up and hold the **<CANCEL>** switch to RES+. The set vehicle speed will increase in increments of 10 km/h or 5 MPH.
- Push up the **<CANCEL>** switch to RES+ and then quickly release it. Each time you do this, the set speed will increase by approximately 1 km/h (1 MPH).

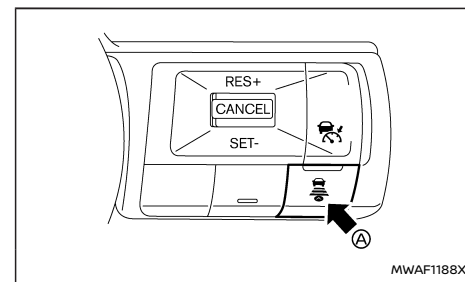
To reset at a slower cruising speed, use one of the following methods:

- Lightly tap the brake pedal. When the vehicle attains the desired speed, push down the **<CANCEL>** switch to SET- and release it.

- Push down and hold the **<CANCEL>** switch to SET-. The set vehicle speed will decrease in increments of 10 km/h or 5 MPH.
- Push down the **<CANCEL>** switch to SET- and then quickly release it. Each time you do this, the set speed will decrease by approximately 1 km/h (1 MPH).

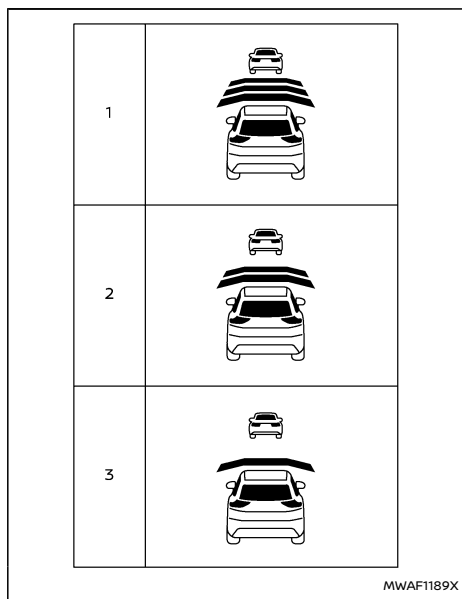
To resume the preset speed, push up the **<CANCEL>** switch to RES+ and release it. The vehicle will resume the last set cruising speed when the vehicle speed is over 30 km/h (20 MPH).

How to change the set distance to the vehicle ahead



The distance to the vehicle ahead can be selected at the time of the ICC standby or the ICC is active.

Each time the DISTANCE switch **A** is pushed, the set distance will change to long, middle, short and back to long again in that sequence.



MWAFF1189X

Example**Distance — approximate distance at 100 km/h (60 MPH)**

1. Far – 60 m (200 ft)
 2. Middle – 45 m (150 ft)
 3. Near – 30 m (100 ft)
- The distance to the vehicle ahead will change according to the vehicle speed. The higher the vehicle speed, the longer the distance.

- The distance setting will remain at the current setting even if the e-POWER system is re-started.

Approach warning

If your vehicle comes closer to the vehicle ahead due to rapid deceleration of that vehicle or if another vehicle cuts in, the system warns the driver with the chime and ICC system display. Decelerate by depressing the brake pedal to maintain a safe vehicle distance if:

- The chime sounds.
 - The vehicle ahead detection indicator blinks.
- The warning chime may not sound in some cases when there is a short distance between vehicles. Some examples are:
- When the vehicles are travelling at the same speed and the distance between vehicles is not changing.
 - When the vehicle ahead is travelling faster and the distance between vehicles is increasing.
 - When a vehicle cuts in near your vehicle.

The warning chime will not sound when:

- Your vehicle approaches other vehicles that are parked or moving slowly.
- The accelerator pedal is depressed, overriding the system.

NOTE:

The approach warning chime may sound and the system display may blink when the radar sensor detects objects on the side of the vehicle or on the side of the road. This may cause the

ICC system to decelerate or accelerate the vehicle. The radar sensor may detect these objects when the vehicle is driven on winding roads, narrow roads, hilly roads or when entering or exiting a curve. In these cases you will have to manually control the proper distance ahead of your vehicle.

Also, the sensor sensitivity can be affected by vehicle operation (steering manoeuvre or driving position in the lane) or traffic or vehicle condition (for example, if a vehicle is being driven with some damage).

Acceleration when passing (where fitted)

Passing on the left-hand side (for countries where traffic travels on the right-hand side of the road):

When the ICC system is engaged above 70 km/h (45 MPH) and following a slower vehicle (below ICC set speed), and the turn signal is activated to the left, the ICC system will automatically start to accelerate the vehicle to help initiate passing on the left and will begin to reduce the distance to vehicle directly ahead. Only the left side turn signal operates this feature. As the driver steers the vehicle and moves into the passing lane, if no vehicle is detected ahead the ICC system will continue to accelerate to the ICC system set speed. If another vehicle is detected ahead, then the vehicle will accelerate up to the following speed of that vehicle. If the vehicle is not steered into the left lane to pass, the acceleration will stop after a short time and regain the set following distance. Acceleration can be stopped at any point

by depressing the brake pedal or the <CANCEL> switch on the steering wheel.

Passing on the right-hand side (for countries where traffic travels on the left-hand side of the road):

When the ICC system is engaged above 70 km/h (45 MPH) and following a slower vehicle (below ICC set speed), and the turn signal is activated to the right, the ICC system will automatically start to accelerate the vehicle to help initiate passing on the right and will begin to reduce the distance to vehicle directly ahead. Only the right side turn signal operates this feature. As the driver steers the vehicle and moves into the passing lane, if no vehicle is detected ahead the ICC system will continue to accelerate to the ICC system set speed. If another vehicle is detected ahead, then the vehicle will accelerate up to the following speed of that vehicle. If the vehicle is not steered into the right lane to pass, the acceleration will stop after a short time and regain the set following distance. Acceleration can be stopped at any point by depressing the brake pedal or the <CANCEL> switch on the steering wheel.

WARNING

In order to reduce the risk of a collision that may result in serious injury or death, please be aware of the following:

- This function is only activated with the left or right turn signal and will briefly accelerate the vehicle even if a lane change is not initiated. This can include non-passing situations such as left or right side exits.

- Ensure that when passing another vehicle, the adjacent lane is clear before initiating the pass. Sudden changes in traffic may occur while passing. Always manually steer or brake as needed. Never solely rely on the system.

Speed Limit Link (where fitted)

WARNING

Listed below are the system limitations for the Speed Limit Link. Failure to operate the vehicle in accordance with these system limitations could result in serious injury or death:

- It is the driver's responsibility to select the proper speed, follow all traffic regulations and observe other road users.
- The Speed Limit Link may not operate properly and the actual speed limit may not be applied to the vehicle set speed in all conditions. The driver must manually control the vehicle speed.

Below are some examples:

- When the Traffic Sign Recognition (TSR) system is not functioning properly or turned off. (See "Traffic Sign Recognition (TSR) (where fitted)" (P.257).)
- When driving in an area with nearby parallel roads (for example, freeway with a parallel service drive).
- When driving in an area where each lane has a different speed limit sign.

- When driving on a road under construction or in a construction zone.
- When end of the speed limit sign is indicated.
- When the speed unit selected in the vehicle information display is different to the unit of the speed limit sign.

When the ICC system is active and it detects a change of the speed limit is detected, the new speed limit is indicated and it can be applied to the vehicle set speed manually.

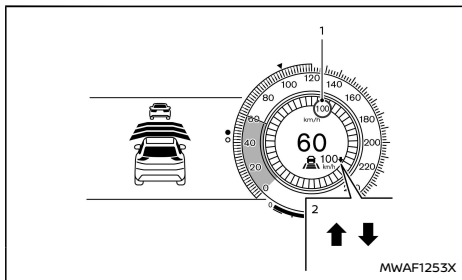
The Speed Limit Link operates:

- When the detected speed limit is 30 km/h (20 MPH) and above.
- The [Speed Limit Link] is enabled in the settings menu of the vehicle information display.

NOTE:

- In the following situations, the Speed Limit Link will not operate:
 - When an increase in the posted speed limit is detected, but the vehicle set speed is already faster than the new speed limit.
 - When a decrease in the posted speed limit is detected, but the vehicle set speed is already lower than the new speed limit.

System display and indicators:



Example

1. Detected speed limit indicator
Displays the currently detected speed limit. For additional information, see "Traffic Sign Recognition (TSR) (where fitted)" (P.257).
Applied speed limit indicator (green frame)
Indicates the detected speed limit can be applied to the vehicle set speed.
2. Speed Limit Link indicator
Indicates the system operation.
" ↑ " : Manual mode is activated and a new speed limit (faster speed value) is indicated.
" ↓ " : Manual mode is activated and a new speed limit (lower speed value) is indicated.

Operating the system:

When the system detects a different speed limit, the new speed value is indicated. The vehicle set speed can be changed to the indicated speed limit manually.

- To accept the newly indicated speed limit, perform the RES+ operation (in case of speed limit up) or SET- operation (in case of speed limit down).
- The Speed Limit Link indicator (↑ or ↓) will turn off after approximately 15 seconds if the RES+ or SET- operation is not performed. (The Speed Limit Link indicator can be turned off immediately by operating the opposite switch from the direction indicated by the Speed Limit Link indicator.)

The system will not activate if a speed limit change is not detected.

How to activate or deactivate the system:

1. Push the ◀ ▶ button on the steering wheel until [Settings] appears in the vehicle information display, and push the scroll dial.
2. Use the scroll dial to select [Driver Assistance]. Then push the scroll dial.
3. Select [Speed Limit Link] and push the scroll dial to turn the system on or off.

NOTE:

The system will retain current settings in the vehicle information display even if the e-POWER system is restarted.

Selecting Speed Link Offset:

It is possible to set whether the speed limit should be accepted exactly, or with a tolerance of -10 km/h (-5 MPH) to +10 km/h (+5 MPH).

1. Push the ◀ ▶ button on the steering wheel until [Settings] appears in the vehicle information display, and push the scroll dial.

2. Use the scroll dial to select [Driver Assistance]. Then push the scroll dial.
3. Select [Speed Link Offset] and push the scroll dial to select tolerance value. (Select [OFF] to turn off the function.)

NOTE:

The function will retain current settings in the vehicle information display even if the e-POWER system is restarted.

Automatic cancellation

A chime sounds under the following conditions and the control is automatically cancelled.

- When the vehicle ahead is not detected and your vehicle is travelling below the speed of 25 km/h (15 MPH)
- When the system judges the vehicle is at standstill
- When the shift lever is not in the D (Drive) position
- When the parking brake is applied
- When the ESP system is turned off
- When ESP (including the traction control system) operates
- When the SNOW mode or OFF-ROAD mode is selected (4WD models)
- When distance measurement becomes impaired due to adhesion of dirt or obstruction to the sensor
- When a wheel slips
- When the radar signal is temporarily interrupted

- On repeated uphill and downhill roads

Vehicle-to-vehicle distance control mode limitations

WARNING

Listed below are the system limitations for the ICC system. Failure to operate the vehicle in accordance with these system limitations could result in serious injury or death.

- The system is primarily intended for use on straight, dry, open roads with light traffic. It is not advisable to use the system in city traffic or congested areas.
- This system will not adapt automatically to road conditions. This system should be used in evenly flowing traffic. Do not use the system on roads with sharp curves, steep uphill and downhill, or on icy roads, in heavy rain or in fog.
- As there is a performance limit to the distance control function, never rely solely on the ICC system. This system does not correct careless, inattentive or absent-minded driving, or overcome poor visibility in rain, fog, or other bad weather. Decelerate the vehicle speed by depressing the brake pedal, depending on the distance to the vehicle ahead and the surrounding circumstances in order to maintain a safe distance between vehicles.
- Always pay attention to the operation of the vehicle and be ready to manually control the proper following distance. The vehicle-to-vehicle distance control mode

of the ICC system may not be able to maintain the selected distance between vehicles (following distance) or selected vehicle speed under some circumstances.

- The system may not detect the vehicle in front of you in certain road or weather conditions. To avoid accidents, never use the ICC system under the following conditions:
 - On roads where the traffic is heavy or there are sharp curves
 - On slippery road surfaces such as on ice or snow, etc.
 - During bad weather (rain, fog, snow, etc.)
 - When rain, snow or dirt adhere to the system sensor
 - On steep downhill roads (the vehicle may go beyond the set vehicle speed and frequent braking may result in overheating the brakes)
 - On repeated uphill and downhill roads
 - When traffic conditions make it difficult to keep a proper distance between vehicles because of frequent acceleration or deceleration
 - Interference by other radar sources
- In some road or traffic conditions, a vehicle or object can unexpectedly come into the sensor detection zone and cause automatic braking. You may need to control the distance from other vehicles using the

accelerator pedal. Always stay alert and avoid using the ICC system when it is not recommended in this section.

- Do not use the ICC system if you are towing a trailer or other vehicle. The system may not detect a vehicle ahead.

The radar sensor will not detect the following objects:

- Stationary and slow moving vehicles
- Pedestrians or objects in the roadway
- Oncoming vehicles in the same lane
- Motorcycles travelling offset in the travel lane

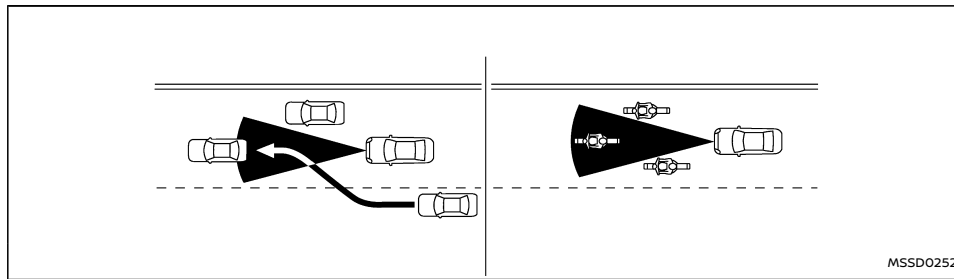
The sensor generally detects the signals returned from the vehicle ahead. Therefore, if the sensor cannot detect the reflection from the vehicle ahead, the ICC system may not maintain the selected distance.

The following are some conditions in which the sensor cannot detect the signals:

- When the snow or road spray from travelling vehicles reduces the sensor's visibility
- When excessively heavy baggage is loaded in the rear seat or the luggage compartment of your vehicle
- When your vehicle is towing a trailer, etc.

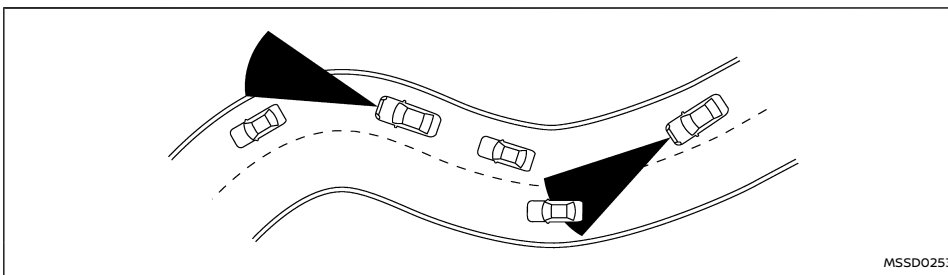
The ICC system is designed to automatically check the sensor's operation within the limitation of the system. When the sensor is covered with dirt or is obstructed, the system will automatically be cancelled. If the sensor is covered with ice, a transparent or translucent vinyl bag, etc., the ICC system may not detect them. In these instances,

the vehicle-to-vehicle distance control mode may not cancel and may not be able to maintain the selected following distance from the vehicle ahead. Be sure to check and clean the sensor regularly.



The detection zone of the radar sensor is limited. A vehicle ahead must be in the detection zone for the vehicle-to-vehicle distance detection mode to maintain the selected distance from the vehicle ahead.

A vehicle ahead may move outside of the detection zone due to its position within the same lane of travel. Motorcycles may not be detected in the same lane ahead if they are travelling offset from the centerline of the lane. A vehicle that is entering the lane ahead may not be detected until the vehicle has completely moved into the lane. **If this occurs, the ICC system may warn you by blinking the system indicator and sounding the chime. The driver may have to manually control the proper distance away from vehicle travelling ahead.**



When driving on some roads, such as winding, hilly, curved, narrow roads, or roads which are under construction, the radar sensor may detect vehicles in a different lane, or may temporarily not detect a vehicle travelling ahead. This may cause the ICC system to decelerate or accelerate the vehicle.

The detection of vehicles may also be affected by vehicle operation (steering manoeuvre or travelling position in the lane, etc.) or vehicle condition. **If this occurs, the ICC system may warn you by blinking the system indicator and sounding the chime unexpectedly. You will have to manually control the proper distance away from the vehicle travelling ahead.**

System temporarily unavailable

The following are conditions in which the ICC system may be temporarily unavailable. In these instances, the ICC system may not cancel and may not be able to maintain the selected following distance from the vehicle ahead.

Condition A:

Under the following conditions, the ICC system is automatically cancelled. A chime will sound and the system will not be able to be set:

- When the ESP is turned off
- When the ESP (including the traction control system) operates
- When the [SNOW] mode or [OFF-ROAD] mode is selected (4WD models)
- When a vehicle ahead is not detected and your vehicle is travelling below the speed of 25 km/h (15 MPH)
- When the system judges the vehicle is at a standstill
- When the shift lever is not in the D (Drive) position
- When the parking brake is applied
- When a tyre slips
- When the radar signal is temporarily interrupted

- When any door is open
- On repeated uphill and downhill roads

Action to take:

When the conditions listed above are no longer present, turn the ICC system back on to use the system.

Condition B:

The chime will sound and the [Temporarily Disabled Front Radar Blocked] warning message will appear in the vehicle information display.

- When the radar sensor area is covered with dirt or is obstructed, or the front radar is impaired due to dirt or another obstruction blocking the radar sensor, making it impossible to detect a vehicle ahead, the ICC system is automatically cancelled.

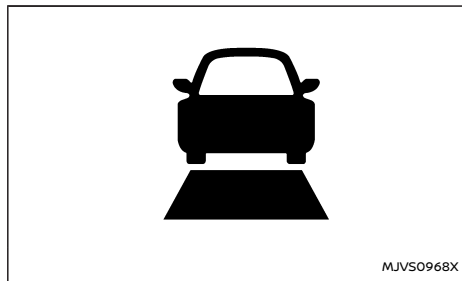
Action to take:

If the warning message appears, stop the vehicle in a safe place, push the P position switch to engage the P (Park) position, and turn the e-POWER system off. When the radar signal is temporarily interrupted, clean the sensor area and restart the e-POWER system. If the [Temporarily Disabled Front Radar Blocked] warning message continues to be displayed, have the ICC system checked by a NISSAN dealer or qualified workshop.

- When driving on roads with limited road structures or buildings (for example, long bridges, deserts, snow fields, driving next to long walls), the system may display the [Temporarily Disabled Front Radar Blocked] warning message in the vehicle information display.

Action to take:

When the conditions listed above are no longer present, turn the ICC system back on to use the system.

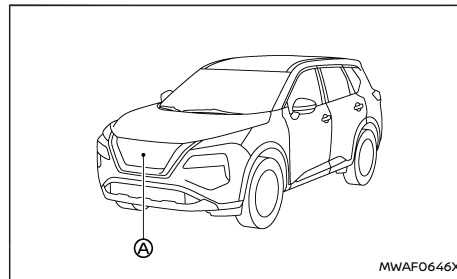
System malfunction

When the ICC system is not operating properly, the chime sounds and the ICC system warning (yellow) and the [System fault See Owner's Manual] warning message will appear.

Action to take:

If the warning appears, push the P position switch to shift to the P (Park) position, turn the e-POWER system off, restart the e-POWER system, resume driving, and set the ICC system again.

If it is not possible to set the system or the warning stays on, it may indicate that the ICC system is malfunctioning. Although the vehicle is still driveable under normal conditions, have the vehicle checked. See a NISSAN dealer or qualified workshop for this service.

System maintenance

The sensor for the ICC system Ⓐ is located on the front of the vehicle.

To keep the ICC system operating properly, be sure to observe the following:

- Always keep the sensor area clean.
- Do not strike or damage the areas around the sensor.
- Do not cover or attach stickers or similar objects near the sensor area. This could cause failure or malfunction.
- Do not attach metallic objects near the sensor area (brush guard, etc.). This could cause failure or malfunction.
- Do not alter, remove or paint the front bumper. Contact a NISSAN dealer or qualified workshop before customising or restoring the front bumper.

Radio frequency statement:

For the other radio approval numbers and information, see "Radio approval number and information" (P.466).

CONVENTIONAL (fixed speed) CRUISE CONTROL MODE

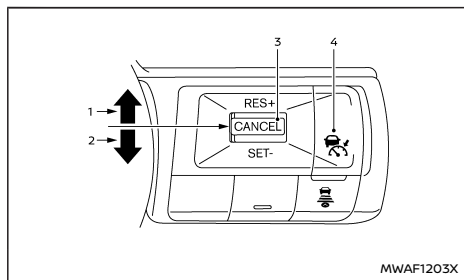
This mode allows driving at a speed above approximately 30 (20 MPH) without keeping your foot on the accelerator pedal.

⚠ WARNING

- **In the conventional (fixed speed) cruise control mode, a warning chime does not sound to warn you if you are too close to the vehicle ahead, as neither the presence of the vehicle ahead nor the vehicle-to-vehicle distance is detected.**
- **Pay special attention to the distance between your vehicle and the vehicle ahead of you or a collision could occur.**
- **Always confirm the setting in the ICC system display.**
- **Do not use the conventional (fixed speed) cruise control mode when driving under the following conditions:**
 - **When it is not possible to keep the vehicle at a set speed**
 - **In heavy traffic or in traffic that varies in speed**
 - **On winding or hilly roads**
 - **On slippery roads (rain, snow, ice, etc.)**
 - **In very windy areas**

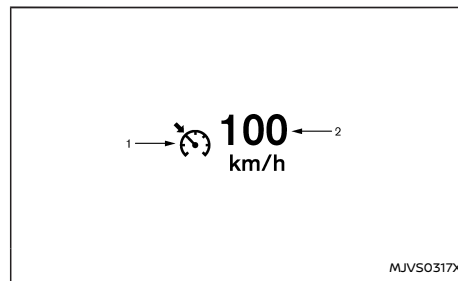
- **Doing so could cause a loss of vehicle control and result in an accident.**

Conventional (fixed speed) cruise control switches



1. **RES+ operation:**
Resumes vehicle set speed or increases speed incrementally
2. **SET- operation:**
Sets desired cruise speed or reduces speed incrementally
3. **<CANCEL> switch:**
Deactivates the system without erasing the vehicle set speed
4. **Cruise ON/OFF switch:**
Main switch to activate or deactivate the system

Conventional (fixed speed) cruise control mode display and indicators



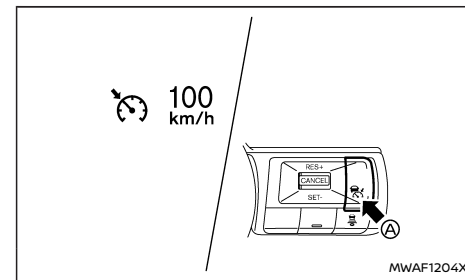
The display is located in the vehicle information display.

1. **Cruise indicator:**
This indicator indicates the condition of the conventional (fixed speed) cruise control mode of the ICC system depending on a colour.
 - Cruise control ON indicator (grey): Indicates that the Cruise ON/OFF switch is on
 - Cruise control SET indicator (green): Indicates that the cruising speed is set
 - Cruise control warning (yellow): Indicates that there is a malfunction in the conventional (fixed speed) cruise control mode of the ICC system
2. **Vehicle set speed indicator:**
This indicator indicates the vehicle set speed.

- Green: Cruise control active
- Grey: Cruise control standby

(The speed unit can be converted between [km/h] and [MPH] (where fitted). See "Unit/Language" (P.100).)

Operating conventional (fixed speed) cruise control mode



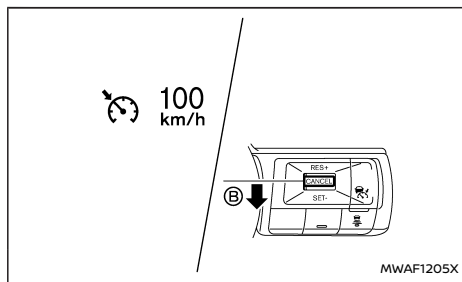
To turn on the conventional (fixed speed) cruise control mode, push and hold the Cruise ON/OFF switch **A** for longer than about 1.5 seconds.


When pushing the Cruise ON/OFF switch on, the ICC system display and indicators are displayed in the vehicle information display. After you hold the Cruise ON/OFF switch on for longer than about 1.5 seconds, the ICC system display turns off. The cruise indicator appears. You can now set your desired cruising speed. Pushing the Cruise ON/OFF switch again will turn the system completely off. When the power switch is placed in the OFF position, the system is also automatically turned off.

To use the ICC system again, quickly push and release the Cruise ON/OFF switch (vehicle-to-vehicle distance control mode) or push and hold it (conventional cruise control mode) again to turn it on.

WARNING

To avoid accidentally engaging cruise control, make sure to turn the Cruise ON/OFF switch off when not using the ICC system.



To set cruising speed, accelerate your vehicle to the desired speed, push down the **<CANCEL>** switch to SET-  and release it. (The colour of the cruise indicator changes to green and vehicle set speed indicator comes on.) Take your foot off the accelerator pedal. Your vehicle will maintain the set speed.

- To pass another vehicle, depress the accelerator pedal. When you release the pedal, the vehicle will return to the previously set speed.

- The vehicle may not maintain the set speed when going up or down steep hills. If this happens, manually maintain vehicle speed.

To cancel the preset vehicle speed, use any of the following methods:

- Push the **<CANCEL>** switch. The vehicle set speed indicator and the cruise indicator will turn grey.
- Tap the brake pedal. The vehicle set speed indicator and the cruise indicator will turn grey.
- Turn the Cruise ON/OFF switch off. Both the cruise indicator and vehicle set speed indicator will turn off.

To reset at a faster cruising speed, use one of the following three methods:

- Depress the accelerator pedal. When the vehicle attains the desired speed, push down the **<CANCEL>** switch to SET- and release it.
- Push up and hold the **<CANCEL>** switch to RES+. When the vehicle attains the desired speed, release the switch.
- Push up the **<CANCEL>** switch to RES+, then quickly release it. Each time you do this, the vehicle set speed will increase by about 1 km/h (1 MPH).

To reset at a slower cruising speed, use one of the following three methods:

- Lightly tap the brake pedal. When the vehicle attains the desired speed, push down the **<CANCEL>** switch to SET- and release it.
- Push down and hold the **<CANCEL>** switch to

SET-. Release the switch when the vehicle slows down to the desired speed.

- Push down the **<CANCEL>** switch to SET- and then quickly release it. Each time you do this, the vehicle set speed will decrease by about 1 km/h (1 MPH).

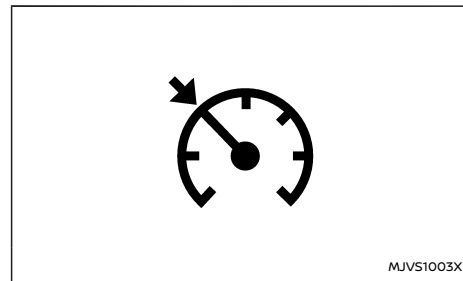
To resume the preset vehicle speed, push up the **<CANCEL>** switch to RES+ and release it. The vehicle will resume the last set cruising speed when the vehicle speed is over 30 km/h (20 MPH).

System temporarily unavailable

A chime sounds under the following conditions and the control is automatically cancelled.

- When the shift lever is not in the D (Drive) position
- When the parking brake is applied
- When the ESP system (including the traction control system) operates
- When the ESP system is turned off
- When a wheel slips

Warning



PROPILOT ASSIST (where fitted)

When the system is not operating properly, the chime sounds and the colour of the cruise indicator will change to yellow.

Action to take:

If the colour of the cruise indicator changes to yellow, park the vehicle in a safe place. Turn the e-POWER system off, restart the e-POWER system, resume driving and then perform the setting again.

If it is not possible to set or the indicator stays on, it may indicate that the system is malfunctioning. Although the vehicle is still driveable under normal conditions, have the system checked. It is recommended you visit a NISSAN dealer or qualified workshop for this service.

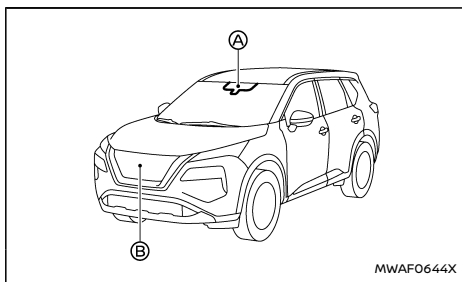
WARNING

Failure to follow the warnings and instructions for proper use of the ProPILOT Assist system could result in serious injury or death.

- ProPILOT Assist is not a self-driving system. Within the limits of its capabilities, as described in this manual, it helps the driver with certain driving activities.
- The ProPILOT Assist system is not a replacement for proper driving procedures and is not designed to correct careless, inattentive or absent-minded driving. ProPILOT Assist will not always steer the vehicle to keep it in the lane. The ProPILOT Assist system is not designed to prevent loss of control. It is the driver's responsibility to stay alert, drive safely, keep the vehicle in the travelling lane, and be in control of the vehicle at all times.
- There are limitations to the ProPILOT Assist system capability. The ProPILOT Assist system does not function in all driving, traffic, weather, and road conditions. It is the driver's responsibility to stay alert, drive safely, keep the vehicle in the travelling lane, and be in control of the vehicle at all times.
- The ProPILOT Assist system is only an aid to assist the driver and is not a collision warning or avoidance device.
- The ProPILOT Assist system is for use on highways with opposing traffic separated by a barrier only, and is not intended for

city driving. Failure to apply the brakes or steer the vehicle when necessary may result in a serious accident.

- Always observe posted speed limits and do not set the speed over them.
- Never take your hands off the steering wheel when driving. Always keep your hands on the steering wheel and drive your vehicle safely.
- Never unfasten your safety belt when using ProPILOT Assist. Doing so automatically cancels the ProPILOT Assist system.
- The ProPILOT Assist system does not react when approaching stationary or slow moving vehicles.
- Always drive carefully and attentively when using the ProPILOT Assist system. Read and understand the Owner's Manual thoroughly before using the ProPILOT Assist system. To avoid serious injury or death, do not rely on the system to prevent accidents or to control the vehicle's speed in emergency situations. Do not use the ProPILOT Assist system except in appropriate road and traffic conditions.

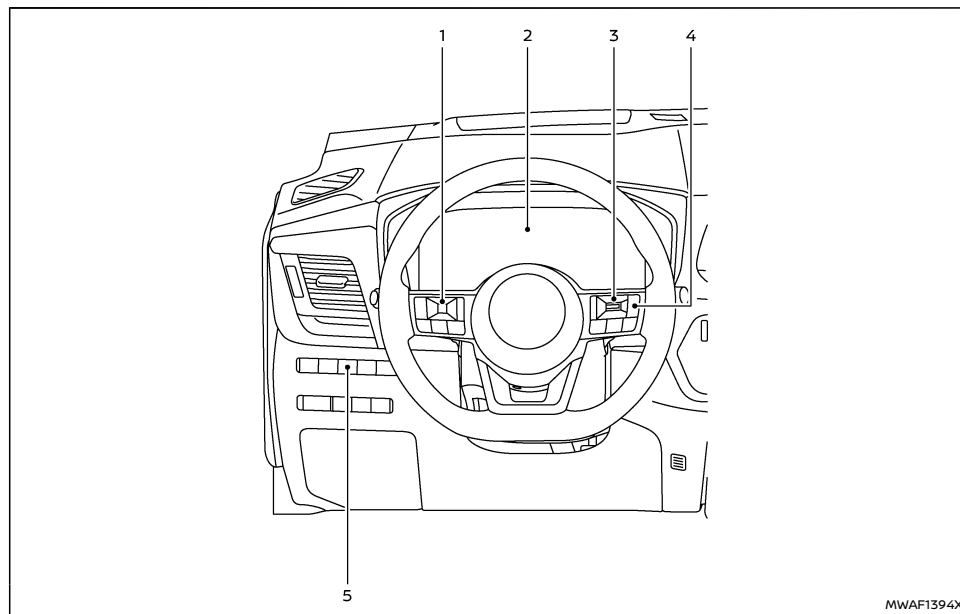


The ProPILOT Assist system is intended to enhance the operation of the vehicle when following a vehicle travelling in the same lane and direction.

The ProPILOT Assist system uses a multi-sensing front camera (A) installed behind the windscreen to monitor the lane markers and a radar sensor (B) located on the front of the vehicle to measure the distance to the vehicle ahead in the same lane. If the system detects a slower moving vehicle ahead, the system will reduce the vehicle speed so that your vehicle follows the vehicle in front at the selected distance. The system will also help keep the vehicle centered in the travelling lane when clear lane markings are detected.

NOTE:

It is important to ensure the front camera and radar sensors are clear at all times. (See "ICC sensor maintenance" (P.331) and "Steering Assist maintenance" (P.335) for more details.)



- ① Steering-wheel-mounted control (left)
- ② Vehicle information display
- ③ Steering-wheel-mounted control (right)
- ④ ProPILOT Assist switch
- ⑤ Steering Assist switch

PROPILOT ASSIST SYSTEM OPERATION

The ProPILOT Assist system has the following two functions:

1. Intelligent Cruise Control (ICC)

The ICC system can be set to one of two cruise control modes:

- Conventional (fixed speed) cruise control mode:

For cruising at a preset vehicle speed

For additional information, see "Turning the conventional (fixed speed) cruise control mode ON" (P.314).

NOTE:

Steering Assist is not available in the conventional (fixed speed) cruise control mode.

- Vehicle-to-vehicle distance control mode:
The ICC system maintains a selected distance from the vehicle in front of you within the speed range of 0 km/h (0 MPH) up to the set speed. The set speed can be selected by the driver above approximately 30 km/h (20 MPH). When the vehicle ahead slows to a stop, your vehicle gradually decelerates to a standstill. When the vehicle is stopped, the ICC system maintains braking force to keep your vehicle stationary.
- When your vehicle is stopped for less than approximately 3 seconds and the vehicle ahead begins to move, your vehicle will start moving again automatically. If your vehicle is stationary for more than approximately 3 minutes, the ICC system will be switched off and the electronic parking brake will be applied.
- When the vehicle ahead begins to move forward, push up the **<CANCEL>** switch to RES+ on the steering wheel or lightly depress the accelerator pedal to release the brake. The

ICC system will restart to maintain a selected distance from the vehicle in front of you.

- Always check surroundings before restarting the vehicle.
- When stationary and no vehicle is detected ahead, the ICC system will not function. The accelerator pedal should be used to control the vehicle speed.

NOTE:

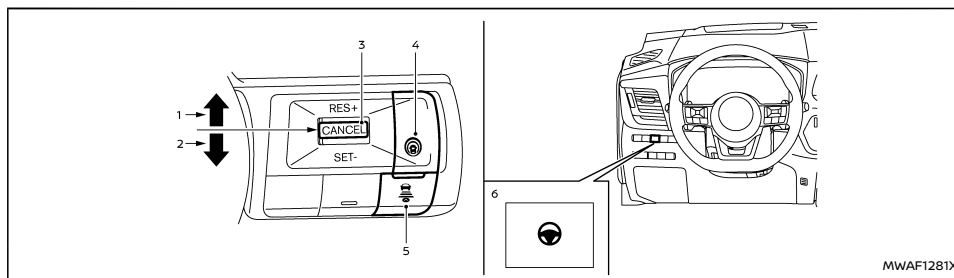
Even if the Intelligent Emergency Braking with Pedestrian Detection system setting is turned off by the driver using the [Settings] menu in the vehicle information display, Intelligent Emergency Braking with Pedestrian Detection system will be automatically turned on when ICC is used.

2. Steering Assist

The Steering Assist function controls the steering system to help keep your vehicle within the travelling lane.

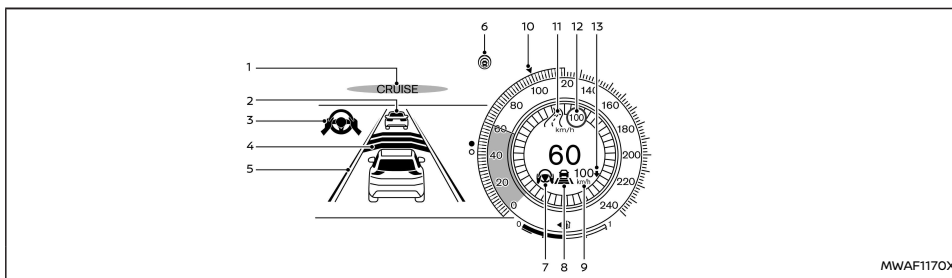
When there is no vehicle ahead, Steering Assist is not available at speeds under 60 km/h (37 MPH).

PROPILOT ASSIST SWITCHES



1. RES+ operation:
Resumes vehicle set speed or increases speed incrementally
2. SET- operation:
Sets desired cruise speed or reduces speed incrementally
3. **<CANCEL>** switch:
Deactivates the ProPILOT Assist system without erasing the set speed
4. ProPILOT Assist switch:
Turns the ProPILOT Assist system on or off
5. DISTANCE switch:
 - [Far]
 - [Middle]
 - [Near]
6. Steering Assist switch:
Turns the Steering Assist function on or off

PROPILOT ASSIST SYSTEM DISPLAY AND INDICATORS



Models with full-screen display

1. ProPILOT Assist activation

Displays once the ProPILOT Assist system is activated

2. Vehicle ahead detection indicator

Displays whether the system detects a vehicle in front of you (only when ICC is active)

3. Steering Assist indicator

Indicates the status of the Steering Assist function by the colour of the indicator

- Steering Assist indicator (grey): Steering Assist standby
- Steering Assist indicator (green): Steering Assist active

4. Set distance indicator

Displays the selected distance

5. Lane marker indicator

Indicates whether the system detects lane markers

- No lane markers displayed: Steering Assist is turned off
- Lane marker indicator (grey): No lane markers detected
- Lane marker indicator (green): Lane markers detected, Steering Assist is active
- Lane marker indicator (yellow): Lane departure is detected

6. ProPILOT Assist status indicator ()

Indicates the status of the ProPILOT Assist system by the colour of the indicator

- ProPILOT Assist status indicator (white): ProPILOT Assist is on but in standby
- ProPILOT Assist status indicator (blue): ProPILOT Assist active

7. Steering Assist status indicator/warning (,)

Displays the status of the Steering Assist by the colour of the indicator/warning

- No Steering Assist status indicator displayed: Steering Assist is turned off
- Steering Assist status indicator (grey): Steering Assist standby
- Steering Assist status indicator (green): Steering Assist active
- Steering Assist status indicator (yellow): Steering Assist malfunction
- Steering Assist status indicator (red): Hands off detected

8. Speed control status indicator/set distance indicator/lane marker indicator ()

Displays the status of speed control by the colour of the indicator, and displays the selected distance by the number of horizontal bars shown

- Speed control status indicator (white): ICC standby
- Speed control status indicator (green): ICC (distance control mode) is active
 - Green vehicle icon displayed: Vehicle detected ahead
 - No vehicle icon shown: No vehicle detected ahead (Your vehicle maintains the driver-selected set speed.)
- Speed control status indicator (yellow): Indicates an ICC malfunction

For the lane marker indicator, see "Steering Assist display and indicators" (P.332).

9. **Vehicle set speed indicator**

Indicates the vehicle set speed

- Green: ICC active
- Grey: ICC standby

(The speed unit can be converted between [km/h] and [MPH] (where fitted). See "Unit/Language" (P.100).)

10. **Target speed indicator (where fitted)**

Indicates the target vehicle speed

- White triangle: Cruise control or speed limiter (where fitted) target speed
- Green triangle: ICC target speed

11. **Road information indicator (where fitted)** ()

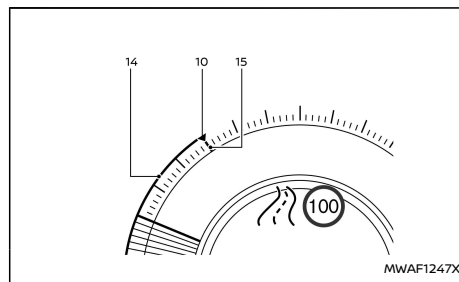
Indicates the detected road information

12. **Detected road sign (speed limit) indicator (where fitted)** ()

Indicates the currently detected speed limit

13. **Speed Limit Link indicator (where fitted)** ()

Indicates the Speed Limit Link activation mode or system operation



14. **Green line (where fitted)**

Indicates a gap between the current speed and the ICC target speed

15. **Red line (where fitted)**

Indicates the Traffic Sign Recognition (TSR) speed limit marker

NOTE:

- **Some of the items listed above are only available in classic view (models with full-screen display), shown in the illustration above. (See "Changing the meter screen view (models with full-screen display)" (P.79).)**
- **When the ProPILOT Assist system is activated, the display will automatically be switched to the ProPILOT Assist system display. To disable this function, turn [AUTO Cruise Display] off under [Display Settings] of the settings menu.**

The ProPILOT Assist display is also shown in the

Head Up Display (HUD) (where fitted). (See "Head Up Display (HUD) (where fitted)" (P.118).)

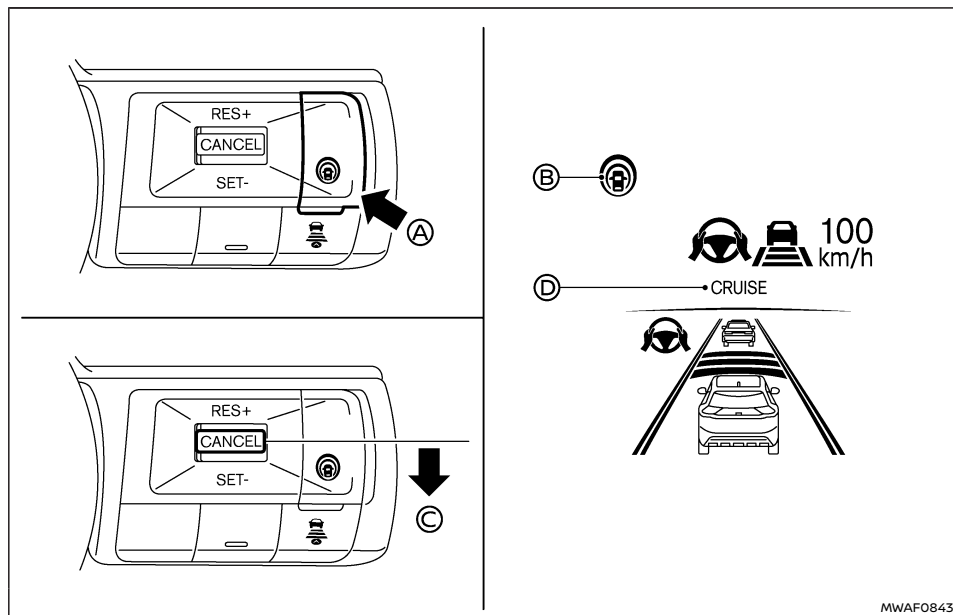
TURNING THE CONVENTIONAL (fixed speed) CRUISE CONTROL MODE ON

NOTE:

ProPILOT Assist provides no approach warnings, automatic braking, or Steering Assist in the conventional (fixed speed) cruise control mode.

To choose the conventional (fixed speed) cruise control mode, push and hold the ProPILOT Assist switch for longer than approximately 1.5 seconds. For additional information, see "Conventional (fixed speed) cruise control mode" (P.336).

OPERATING PROPILOT ASSIST



Example

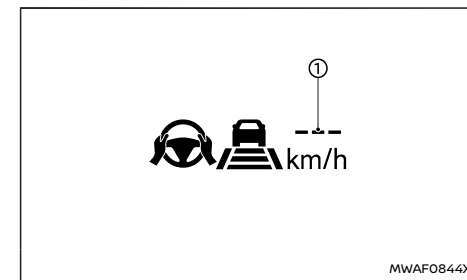
1. Push the ProPILOT Assist switch (A). This turns on the ProPILOT Assist system.
 - The ProPILOT Assist status indicator (B) illuminates in white.
2. Accelerate or decelerate your vehicle to the desired speed and push down the <CANCEL> switch to SET- (C).

The ProPILOT Assist system begins to automatically maintain the vehicle set speed. The ProPILOT Assist activation indicator (D) and

ProPILOT Assist status indicator (B) illuminate in blue. When a vehicle ahead is detected and travelling at a speed of 30 km/h (20 MPH) or below and the <CANCEL> switch is pushed down to SET-, the vehicle set speed is 30 km/h (20 MPH).

NOTE:

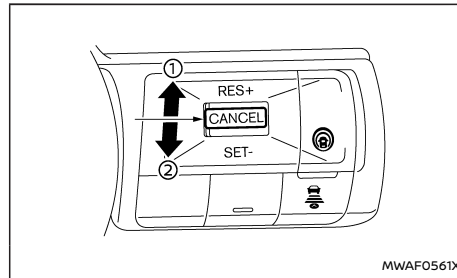
When the Intelligent Blind Spot Intervention system (where fitted) are enabled in the settings menu of the vehicle information display, turning the ProPILOT Assist system on will turn on these systems at the same time. If the Emergency Lane Assist (ELA) system (where fitted) are disabled in the settings menu, the ELA system will automatically be turned on when the Steering Assist system is active. For additional information, see "Intelligent Blind Spot Intervention (where fitted)" (P.276), "Emergency Lane Assist (ELA) (where fitted)" (P.263) or "Emergency Lane Assist (ELA) (where fitted)" (P.333).



When the **<CANCEL>** switch is pushed down to SET- under the following conditions, the ProPILOT Assist system cannot be set and the vehicle set speed indicator ① blinks for approximately 2 seconds:

- When travelling below 30 km/h (20 MPH) and a vehicle ahead is not detected
- When the shift lever is moved out of the D (Drive) position
- When the parking brake is applied
- When the brakes are operated by the driver
- When ProPILOT Park (where fitted) is activated
- When the ESP system is off. For additional information, see “Electronic Stability Programme (ESP) system” (P.372).
- When the ESP system (including the traction control system) is activated
- When the [SNOW] mode or [OFF-ROAD] mode is selected (4WD models)
- When a wheel is slipping
- When any door is open
- When the driver's seat belt is not fastened

How to change the vehicle set speed



The vehicle set speed can be adjusted.

To change to a faster cruising speed:

- Push up and hold the **<CANCEL>** switch to RES + ①. The vehicle set speed increases in increments of 10 km/h or 5 MPH.
- Push up the **<CANCEL>** switch to RES+ ①, then quickly release it. Each time you do this, the vehicle set speed increases by 1 km/h (1 MPH).

To change to a slower cruising speed:

- Push down and hold the **<CANCEL>** switch to SET- ②. The vehicle set speed decreases in increments of 10 km/h or 5 MPH.
- Push down the **<CANCEL>** switch to SET- ②, then quickly release it. Each time you do this, the vehicle set speed decreases by 1 km/h (1 MPH).

How to momentarily accelerate or decelerate

- Depress the accelerator pedal when acceleration is required. Release the accelerator pedal to resume the previously set vehicle speed.
- Depress the brake pedal when deceleration is required. Control by the ProPILOT Assist system is cancelled. Push up the **<CANCEL>** switch to RES+ to resume the previously set vehicle speed.

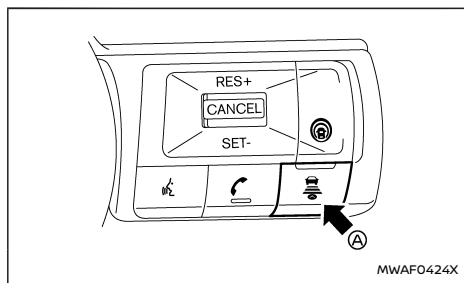
⚠ WARNING

When the accelerator pedal is depressed and you are approaching the vehicle ahead, the ICC system will neither control the brake nor warn the driver with the chime and display. The driver must manually control the vehicle speed to maintain a safe distance to the vehicle ahead. Failure to do so could result in severe personal injury or death.

NOTE:

When you accelerate by depressing the accelerator pedal or decelerate by pushing down the **<CANCEL> switch to SET- and the vehicle travels faster than the speed set by the driver, the vehicle set speed indicator will blink.**

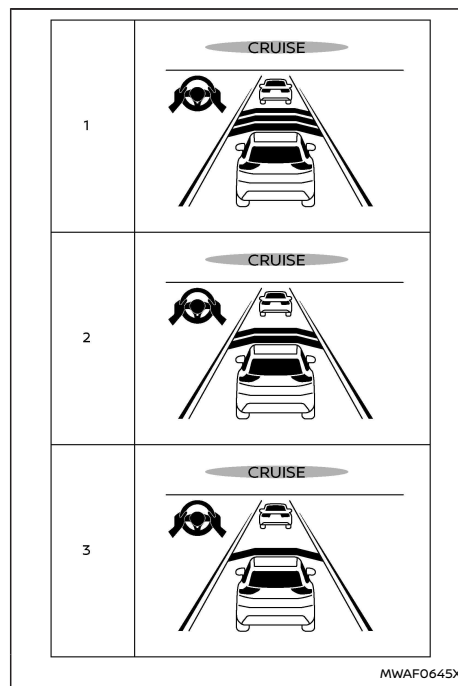
How to change the set distance to the vehicle ahead



Example

The distance to the vehicle ahead can be selected at the time of the ICC standby or the ICC is active.

Each time the DISTANCE switch (A) is pushed, the set distance will change to [Far], [Middle], [Near] and back to [Far] again in that sequence.



Example

Distance — approximate distance at 100 km/h (60 MPH)

1. Far - 60 m (200 ft)

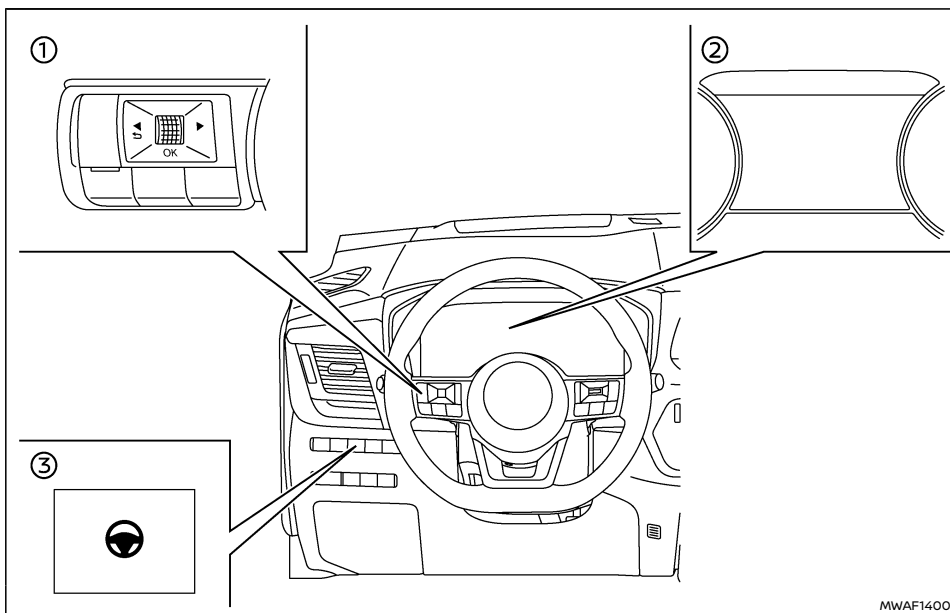
2. Middle - 45 m (150 ft)
3. Near - 30 m (90 ft)

- The actual distance to the vehicle ahead adjusts automatically according to the vehicle speed. The higher the vehicle speed, the longer the distance.

- The distance setting will remain at the current setting even if the e-POWER system is re-started.

HOW TO ENABLE/DISABLE THE STEERING ASSIST

Use the following methods to enable or disable the Steering Assist.



- ① Steering-wheel-mounted control (left)
- ② Vehicle information display
- ③ Steering Assist switch

Steering Assist switch:

To turn the Steering Assist on or off, push the Steering Assist switch ③ on the instrument panel.

NOTE:

- When the Steering Assist switch is used to turn the system on or off, the system remembers the setting even if the power switch is cycled. The switch must be pushed again to change the setting to on or off.
- The Steering Assist switch changes the status of the [Steering Assist] selection

made in the [Settings] screen in the vehicle information display.

Setting in the vehicle information display:

1. Push the ◀ ▶ button on the steering wheel ① until [Settings] appears in the vehicle information display ② and then push the scroll dial.
2. Use the scroll dial to select [Driver Assistance]. Then push the scroll dial.
3. Select [Steering Assist] and push the scroll dial to turn the Steering Assist on or off.

NOTE:

- When the ProPILOT Assist screen is displayed on the vehicle information display, push the scroll dial on the steering wheel to call up the [Driver Assistance] setting display.
- When enabling/disabling the system through the vehicle information display, the system retains the current settings even if the e-POWER system is restarted.

HOW TO CANCEL THE PROPILOT ASSIST SYSTEM

To cancel the ProPILOT Assist system, use one of the following methods:

- Push the <CANCEL> switch.
- Tap the brake pedal (except at a standstill).
- Push the ProPILOT Assist switch to turn the system off. The ProPILOT Assist status indicator will turn off.

When the ProPILOT Assist system is cancelled

while the vehicle is stopped, the electronic parking brake is automatically activated.

WARNING

To prevent the vehicle from moving or rolling unexpectedly, which could result in serious personal injury or property damage, before exiting the vehicle make sure to push the ProPILOT Assist switch to turn the system off, push the P position switch to shift to the P (Park) position, and turn the e-POWER system off.

INTELLIGENT CRUISE CONTROL (ICC)

- The Intelligent Cruise Control (ICC) is a part of the ProPILOT Assist system. To choose the ICC system without the Steering Assist, activate the ProPILOT Assist and then turn off the Steering Assist with the switch or in the settings menu. For additional information, see “Operating ProPILOT Assist” (P.315) and “How to enable/disable the Steering Assist” (P.317).
- To choose the conventional (fixed speed) cruise control mode, push and hold the ProPILOT Assist switch for longer than approximately 1.5 seconds. For additional information, see “Conventional (fixed speed) cruise control mode” (P.336).

WARNING

Failure to follow the warnings and instructions for proper use of the ICC system could result in serious injury or death.

- **The ICC system is only an aid to assist the driver and is not a collision warning or avoidance device. It is recommended for highway use only and it is not intended for congested areas or city driving. It is the driver's responsibility to stay alert, drive safely, and be in control of the vehicle at all times.**
- **There are limitations to the ICC system capability. The ICC system does not function in all driving, traffic, weather, and road conditions. It is the driver's responsibility to stay alert, drive safely, keep the vehicle in the travelling lane, and be in control of the vehicle at all times.**
- **Always observe posted speed limits and do not set the speed over them.**
- **The ICC system does not react to stationary or slow moving vehicles.**
- **Always drive carefully and attentively when using the ICC system. Read and understand the Owner's Manual thoroughly before using the ICC system. To avoid serious injury or death, do not rely on the system to prevent accidents or to control the vehicle's speed in emergency situations. Do not use the ICC system except in appropriate road and traffic conditions.**

ICC system operation

The ICC system is designed to maintain a selected distance from the vehicle in front of you and can reduce the speed to match a slower vehicle ahead. The system decelerates the vehicle as necessary and if the vehicle ahead comes to a stop, the vehicle decelerates to a standstill. However, the ICC system can only apply up to approximately 40% of the vehicle's total braking power.

This system should only be used when traffic conditions allow vehicle speeds to remain fairly constant or when vehicle speeds change gradually. If a vehicle moves into the travelling lane ahead or if a vehicle travelling ahead rapidly decelerates, the distance between vehicles may become closer because the ICC system cannot decelerate the vehicle quickly enough. If this occurs, the ICC system sounds a warning chime and blinks the system display to notify the driver to take necessary action.

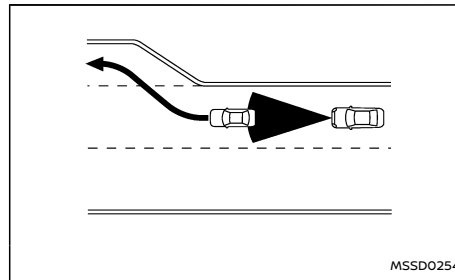
For ProPILOT Assist with Navi-link equipped vehicles on a limited access freeway as identified in the navigation map data, the ICC system cancels and a warning chime sounds if the speed is below approximately 25 km/h (15 MPH) and a vehicle is not detected ahead. The ICC system cancels and a warning chime sounds if your vehicle is at a standstill for more than approximately 3 seconds and a vehicle is not detected ahead.

The ICC system operates as follows:

- When there are no vehicles travelling ahead, the ICC system maintains the speed set by the driver. The vehicle set speed range is above approximately 30 km/h (20 MPH).

- When there is a vehicle travelling ahead, the ICC system adjusts the speed to maintain the distance, selected by the driver, from the vehicle ahead. If the vehicle ahead comes to a stop, the vehicle decelerates to a standstill. Once your vehicle stops, the ICC system keeps the vehicle stopped.
- When your vehicle is at a standstill for more than 3 seconds and the vehicle ahead begins to accelerate, push up the **<CANCEL>** switch to RES+ or lightly depress the accelerator pedal. The ICC system starts to follow the vehicle ahead. If your vehicle is stationary for more than approximately 3 minutes, the ICC system will be switched off and the electronic parking brake will be applied.
- When the vehicle travelling ahead moves to a different travelling lane, while the vehicle speed is above 30 km/h (20 MPH), the ICC system accelerates and maintains vehicle speed up to the set speed.
- When the vehicle travelling ahead moves to a different travelling lane, while the vehicle speed is below 30 km/h (20 MPH), the ICC system cancels and a warning chime sounds.

The ICC system does not control vehicle speed or warn you when you approach stationary and slow moving vehicles. You must pay attention to vehicle operation to maintain proper distance from vehicles ahead when approaching toll gates or traffic congestion.



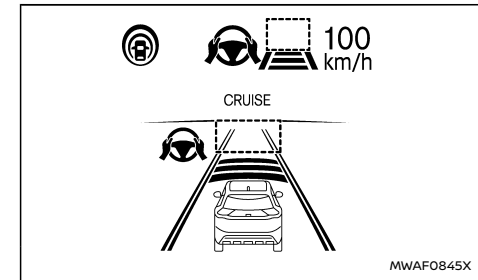
When driving on the highway at a vehicle set speed and approaching a slower travelling vehicle ahead, the ICC system adjusts the speed to maintain the distance, selected by the driver, from the vehicle ahead. If the vehicle ahead changes lanes or exits the highway, the ICC system accelerates and maintains the vehicle set speed. Pay attention to the driving operation to maintain control of the vehicle as it accelerates to the set speed.

The vehicle may not maintain the set speed on winding or hilly roads. If this occurs, you will have to manually control the vehicle speed.

Normally when controlling the distance to a vehicle ahead, the system automatically accelerates or decelerates your vehicle according to the speed of the vehicle ahead.

Depress the accelerator to properly accelerate your vehicle when acceleration is required for a lane change. Depress the brake pedal when deceleration is required to maintain a safe distance to the vehicle ahead due to sudden braking

or if a vehicle cuts in. Always stay alert when using the ICC system.

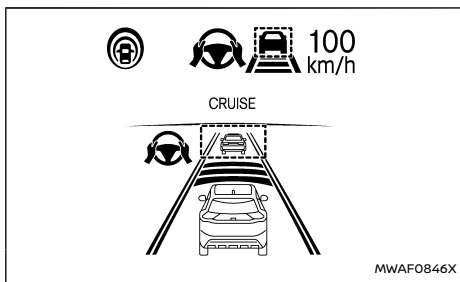


System set display – no vehicle detected ahead*

No vehicle detected ahead:

The driver sets the desired vehicle speed based on the road conditions. The ICC system maintains the vehicle set speed, similar to standard cruise control, as long as no vehicle is detected in the lane ahead. The ICC system displays the vehicle set speed.

*: The design of the set display may differ depending on the model.




System set display – vehicle ahead*

Vehicle detected ahead:

When a vehicle is detected in the lane ahead, the ICC system decelerates the vehicle by controlling the throttle and applying the brakes to match the speed of a slower vehicle ahead. The ICC system then adjusts the vehicle speed based on the speed of the vehicle ahead to maintain the driver selected distance.

NOTE:

- **The brake lights of the vehicle come on when braking is performed by the ICC system.**
- **When the brake is applied by the system, a noise may be heard. This is not a malfunction.**

When the ICC system detects a vehicle ahead, the vehicle ahead detection indicator is displayed and the speed control status indicator  illuminates in green.

*: The design of the set display may differ depending on the model.

Vehicle ahead stops:

When a vehicle ahead is detected and it gradually decelerates to stop, your vehicle decelerates to a standstill. When your vehicle is at a standstill, the [(RES+) Press to Restart] message is displayed on the vehicle information display.

NOTE:

When your vehicle stops for less than 3 seconds, your vehicle will automatically follow the vehicle ahead as it accelerates from a stop. If your vehicle is stationary for more than approximately 3 minutes, the ICC system will be switched off and the electronic parking brake will be applied.

Vehicle ahead accelerates:

- When your vehicle is at a standstill and the vehicle ahead begins to accelerate, push up the **<CANCEL>** switch to RES+ or lightly depress the accelerator pedal. The ICC system starts to follow the vehicle ahead.
- Always check surroundings before restarting the vehicle.

Vehicle ahead not detected:

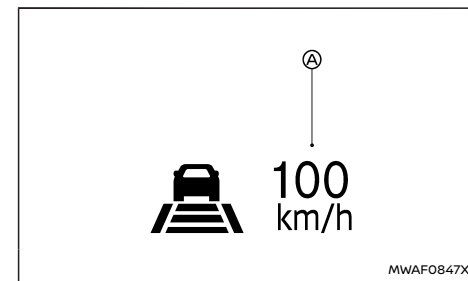
When a vehicle is no longer detected ahead, the ICC system gradually accelerates your vehicle to resume the previously vehicle set speed. The ICC system then maintains the vehicle set speed.


When a vehicle is no longer detected, the vehicle ahead detection indicator and speed control

status indicator (maintain speed control mode) turn off.

The ICC system gradually accelerates to the vehicle set speed, but you can depress the accelerator pedal to quickly accelerate. When a vehicle is no longer detected and your vehicle is travelling under approximately 25 km/h (15 MPH), the ICC system automatically cancels.

For ProPILOT Assist with Navi-link equipped vehicles on a limited access freeway as identified in the navigation map data, the ICC system cancels and a chime sounds if your vehicle is at a standstill for more than approximately 3 seconds and a vehicle is not detected ahead.



When passing another vehicle, the vehicle set speed indicator  flashes when the vehicle speed exceeds the set speed. The vehicle ahead detection indicator turns off when the area ahead of the vehicle is open. When the pedal is released, the vehicle returns to the previously set speed. Even though your vehicle speed is set in the ICC system,

you can depress the accelerator pedal when it is necessary to accelerate your vehicle rapidly.

Approach warning

If your vehicle comes closer to the vehicle ahead due to rapid deceleration of that vehicle or if another vehicle cuts in, the system warns the driver with the chime and ICC system display. Decelerate by depressing the brake pedal to maintain a safe vehicle distance if:

- The chime sounds.
- The vehicle ahead detection indicator blinks.
- You judge it necessary to maintain a safe distance.

The warning chime may not sound in some cases when there is a short distance between vehicles. Some examples are:

- When the vehicles are travelling at the same speed and the distance between vehicles is not changing.
- When the vehicle ahead is travelling faster and the distance between vehicles is increasing.
- When a vehicle cuts in near your vehicle.

The warning chime will not sound when:

- Your vehicle approaches other vehicles that are parked or moving slowly.
- The accelerator pedal is depressed, overriding the system.

NOTE:

The approach warning chime may sound and the system display may flash when the radar sensor detects objects on the side of the vehicle

or on the side of the road. This may cause the ICC system to decelerate or accelerate the vehicle. The radar sensor may detect these objects when the vehicle is driven on winding, narrow, or hilly roads or when the vehicle is entering or exiting a curve. In these cases, you will have to manually control the proper distance ahead of your vehicle.

Also, the sensor sensitivity can be affected by vehicle operation (steering manoeuvre or driving position in the lane) or traffic or vehicle conditions (for example, if a vehicle is being driven with some damage).

Acceleration when passing (where fitted)

Passing on the left-hand side (for countries where traffic travels on the right-hand side of the road):

When the ICC system is engaged above 70 km/h (44 MPH) and following a slower vehicle (below the ICC set speed), and the turn signal is activated to the left, the ICC system will automatically start to accelerate the vehicle to help initiate passing on the left and will begin to reduce the distance to vehicle directly ahead. Only the left side turn signal operates this feature. As the driver steers the vehicle and moves into the passing lane, if no vehicle is detected ahead the ICC system will continue to accelerate to the vehicle set speed. If another vehicle is detected ahead, then the vehicle will accelerate up to the following speed of that vehicle. If the vehicle is not steered into the left lane to pass, the acceleration will stop after a short time and regain the set following distance. Acceleration can be stopped at any point by depressing

the brake pedal or the **<CANCEL>** switch on the steering wheel.

Passing on the right-hand side (for countries where traffic travels on the left-hand side of the road):

When the ICC system is engaged above 70 km/h (44 MPH) and following a slower vehicle (below the ICC set speed), and the turn signal is activated to the right, the ICC system will automatically start to accelerate the vehicle to help initiate passing on the right and will begin to reduce the distance to vehicle directly ahead. Only the right side turn signal operates this feature. As the driver steers the vehicle and moves into the passing lane, if no vehicle is detected ahead the ICC system will continue to accelerate to the vehicle set speed. If another vehicle is detected ahead, then the vehicle will accelerate up to the following speed of that vehicle. If the vehicle is not steered into the right lane to pass, the acceleration will stop after a short time and regain the set following distance. Acceleration can be stopped at any point by depressing the brake pedal or the **<CANCEL>** switch on the steering wheel.

WARNING

In order to reduce the risk of a collision that may result in serious injury or death, please be aware of the following:

- **This function is only activated with the left or right turn signal and will briefly accelerate the vehicle even if a lane change is not initiated. This can include non-passing situations such as left or right side exits.**

- Ensure that when passing another vehicle, the adjacent lane is clear before initiating the pass. Sudden changes in traffic may occur while passing. Always manually steer or brake as needed. Never solely rely on the system.

Speed Limit Link (where fitted)

⚠ WARNING

Listed below are the system limitations for the Speed Limit Link. Failure to operate the vehicle in accordance with these system limitations could result in serious injury or death:

- It is the driver's responsibility to select the proper speed, follow all traffic regulations and observe other road users.
- The Speed Limit Link may not operate properly and the actual speed limit may not be applied to the vehicle set speed in all conditions. The driver must manually control the vehicle speed.

Below are some examples:

- When the Traffic Sign Recognition (TSR) system is not functioning properly or turned off. (See "Traffic Sign Recognition (TSR) (where fitted)" (P.257).)
- When driving in an area with nearby parallel roads (for example, freeway with a parallel service drive).
- When driving in an area where each lane has a different speed limit sign.

- When driving on a road under construction or in a construction zone.
- When end of the speed limit sign is indicated.
- When the speed unit selected in the vehicle information display is different to the unit of the speed limit sign.

When the ICC system is active and a change of the speed limit is detected, the new speed limit is indicated and it can be applied to the vehicle set speed manually.

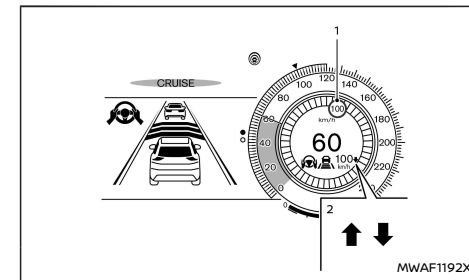
The Speed Limit Link operates:

- When the detected speed limit is 30 km/h (20 MPH) and above.
- The [Speed Limit Link] is enabled in the settings menu of the vehicle information display.

NOTE:

- In the following situations, the Speed Limit Link will not operate:
 - When an increase in the posted speed limit is detected, but the vehicle set speed is already faster than the new speed limit.
 - When a decrease in the posted speed limit is detected, but the vehicle set speed is already lower than the new speed limit.

System display and indicators:





Example

1. Detected speed limit indicator
Displays the currently detected speed limit. For additional information, see "Traffic Sign Recognition (TSR) (where fitted)" (P.257).
Applied speed limit indicator (green frame)
Indicates the detected speed limit can be applied to the vehicle set speed.
2. Speed Limit Link indicator
Indicates the system operation.
"↑": Manual mode is activated and a new speed limit (faster speed value) is indicated.
"↓": Manual mode is activated and a new speed limit (lower speed value) is indicated.



Operating the system:

When the system detects a different speed limit, the new speed value is indicated. The vehicle set speed can be changed to the indicated speed limit manually.

- To accept the newly indicated speed limit, perform the RES+ operation (in case of speed limit up) or SET- operation (in case of speed limit down).
- The Speed Limit Link indicator ( or ) will turn off after approximately 15 seconds if the RES+ or SET- operation is not performed. (The Speed Limit Link indicator can be turned off immediately by operating the opposite switch from the direction indicated by the Speed Limit Link indicator.)

The system will not activate if a speed limit change is not detected.

How to activate or deactivate the system:



1. Push the   button on the steering wheel until [Settings] appears in the vehicle information display, and push the scroll dial.
2. Use the scroll dial to select [Driver Assistance]. Then push the scroll dial.
3. Select [Speed Limit Link] and push the scroll dial to turn the system on or off.

NOTE:

The system will retain current settings in the vehicle information display even if the e-POWER system is restarted.

Selecting Speed Link Offset:

It is possible to set whether the speed limit should be accepted exactly, or with a tolerance of -10 km/h (-5 MPH) to +10 km/h (+5 MPH).

1. Push the   button on the steering wheel until [Settings] appears in the vehicle information display, and push the scroll dial.

2. Use the scroll dial to select [Driver Assistance]. Then push the scroll dial.
3. Select [Speed Link Offset] and push the scroll dial to select tolerance value. (Select [OFF] to turn off the function.)

NOTE:

The function will retain current settings in the vehicle information display even if the e-POWER system is restarted.

Speed Limit Link - a feature of ProPILOT Assist with Navi-link (where fitted)

WARNING

Listed below are the system limitations for the Speed Limit Link. Failure to operate the vehicle in accordance with these system limitations could result in serious injury or death:

- **It is the driver's responsibility to select the proper speed, follow all traffic regulations and observe other road users.**
- **The Speed Limit Link may not operate properly and the actual speed limit may not be applied to the vehicle set speed in all conditions. The driver must manually control the vehicle speed.**

Below are some examples:

- **When the Traffic Sign Recognition (TSR) system is not functioning properly or turned off. (See "Traffic Sign Recognition (TSR) (where fitted)" (P.257).)**

- **When driving in countries or areas not covered by the navigation system.**
- **When crossing national boundaries.**
- **When driving on the exit of the limited access freeway as identified in the navigation map data.**
- **When driving in an area with nearby parallel roads (for example, freeway with a parallel service drive).**
- **When driving in an area where each lane has a different speed limit sign.**
- **When driving on a road under construction or in a construction zone.**
- **When the data from the navigation system is not up-to-date or is unavailable.**

When the ProPILOT Assist with Navi-link is active and it detects a change of the speed limit, the new speed limit is indicated and it can be applied to the vehicle set speed automatically or manually.

The Speed Limit Link operates:

- When the detected speed limit is 30 km/h (20 MPH) and above.
- The [Speed Limit Link] is enabled in the settings menu of the vehicle information display.

NOTE:

- **While the accelerator pedal is operated with [AUTO] mode selected, the Speed Limit Link will function (automatically adjust the vehi-**

cle set speed) only when the detected speed limit is faster than the vehicle set speed.

- In the following situations, the Speed Limit Link will not operate:
 - When an increase in the posted speed limit is detected, but the vehicle set speed is already faster than the new speed limit.
 - When a decrease in the posted speed limit is detected, but the vehicle set speed is already lower than the new speed limit.

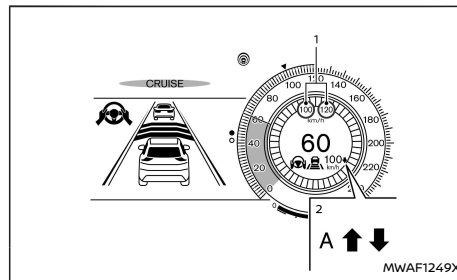
For Germany (No Limit speed setting):

When you turn on the e-POWER system and subsequently enter a freeway with no speed limit, the system initially regulates the speed to 130 km/h (80 MPH). After this, the last speed stored by the driver on a freeway with no speed limit is applied.

NOTE:

This feature only works in Germany.

System display and indicators:



Example

1. Detected speed limit indicator

Left side:

Displays detected impending or anticipated speed limit. This speed limit will only be indicated when a new speed limit (lower speed value) is detected in Manual mode.

Right side:

Displays the currently detected speed limit. For additional information, see "Traffic Sign Recognition (TSR) (where fitted)" (P.257).

Applied speed limit indicator (green frame)

Indicates the detected speed limit can be applied to the vehicle set speed.

2. Speed Limit Link indicator

Indicates the system activation mode or system operation.

"↑": Manual mode is activated and a new speed limit (faster speed value) is indicated.

"↓": Manual mode is activated and a new speed limit (lower speed value) is indicated.

"A": Auto mode is activated.

Operating the system:

When the system detects a different speed limit, the new speed value is indicated. The vehicle set speed can be changed to the indicated speed limit automatically or manually.

When Manual mode is selected on settings menu (factory default setting):

- To accept the newly indicated speed limit, perform the RES+ operation (in case of speed limit up) or SET- operation (in case of speed limit down).
- The Speed Limit Link indicator (↑ or ↓) will turn off after approximately 15 seconds if the RES+ or SET- operation is not performed. (The Speed Limit Link indicator can be turned off immediately by operating the opposite switch from the direction indicated by the Speed Limit Link indicator.)

The system will not activate if a speed limit change is not detected.

When Auto mode is selected on the settings menu:

- The indicated speed limit is applied to the vehicle set speed automatically when on a limited access freeway as identified in the navigation map data. Also, if the ProPILOT Assist with Navi-link system is ON, but not set (active), and a new speed limit is detected, the vehicle set speed is automatically updated.

- The Auto mode may not be available in some regions or on roads other than limited access freeways. In this case, the system operates as the Manual mode.

How to activate or deactivate the system:

1. Push the ◀ ▶ button on the steering wheel until [Settings] appears in the vehicle information display, and push the scroll dial.
2. Use the scroll dial to select [Driver Assistance]. Then push the scroll dial.
3. Select [Speed Limit Link], and push the scroll dial to select [Auto] or [Prompt] to enable (not activate) the system.

To deactivate the system, select [OFF].

NOTE:

The system will retain current settings in the vehicle information display even if the e-POWER system is restarted.

Selecting Speed Link Offset:

It is possible to set whether the speed limit should be accepted exactly, or with a tolerance of -10 km/h (-5 MPH) to +10 km/h (+5 MPH).

1. Push the ◀ ▶ button on the steering wheel until [Settings] appears in the vehicle information display, and push the scroll dial.
2. Use the scroll dial to select [Driver Assistance]. Then push the scroll dial.
3. Select [Speed Link Offset] and push the scroll dial to select tolerance value. (Select [OFF] to turn off the function.)

NOTE:

The function will retain current settings in the vehicle information display even if the e-POWER system is restarted.

CRUISE Navi Link - a feature of ProPILOT Assist with Navi-link (where fitted)

WARNING

Listed below are the system limitations for the CRUISE Navi Link. Failure to operate the vehicle in accordance with these system limitations could result in serious injury or death:

- There are limitations to the CRUISE Navi Link system capability. The system does not function in all driving, traffic, weather and road conditions. It is the driver's responsibility to stay alert, drive safely, and be in control of the vehicle at all times.
- The CRUISE Navi Link system does not brake the vehicle to a stop. Whenever necessary, the driver must apply appropriate braking.
- It is the driver's responsibility to select the proper speed, follow all traffic regulations and observe other road users.
- The availability of the CRUISE Navi Link system is country-dependent. In some countries, for example, Iceland, Malta, Cyprus, this function is not available. The map data quality does not satisfy the system requirements. If the system detects that the vehicle is located in these countries on the basis of GPS information,

the system prohibits activation of the CRUISE Navi Link function.

- The CRUISE Navi Link may not operate properly in some road and traffic conditions, the system may unexpectedly change the speed. The driver must manually control the vehicle speed.

Below are some examples:

- When driving in countries or areas not covered by the navigation system.
- When the data from the navigation system is not up-to-date or is unavailable.
- When not driving along the route suggested by the navigation system.
- When the navigation system is recalculating the route.
- When driving in countries or areas not covered by the navigation system.
- When driving on a road under construction or newly constructed road.
- When driving near a road split or junction.
- When driving in bad weather or poor road conditions.

When the ProPILOT Assist with Navi-link is active on a limited access freeway (as identified in the navigation map data), the CRUISE Navi Link uses road information provided by the navigation system and can adjust the vehicle speed depending on curves, junctions and exits.

The CRUISE Navi Link uses road information provided by the navigation system and can adjust the vehicle speed depending on roundabouts (as identified in the navigation map data).

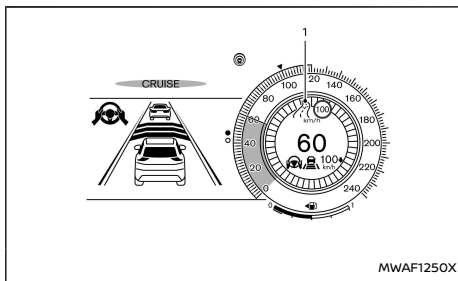
The system may not always reduce speed for all curves, junctions, roundabouts or exits and the driver may need to apply additional braking at any time.

When the vehicle is through the curve, roundabout or junction, the vehicle will accelerate again to the set speed. When exiting the limited access freeway, the driver will need to apply braking at the end of the exit.

NOTE:

- The system does not operate when the accelerator pedal is depressed.
- The system may not operate depending on the set distance to the vehicle ahead and vehicles detected ahead.

System display and indicators:



Example

1. Road information indicator

Appears when the system adjusts the speed depending on turns or exits.

	Curves and junctions
	Right exits
	Left exits
	Roundabouts

How to activate or deactivate the system:

1. Push the ◀ ▶ button on the steering wheel until [Settings] appears in the vehicle information display, and push the scroll dial.
2. Use the scroll dial to select [Driver Assistance]. Then push the scroll dial.
3. Select [CRUISE Navi Link] and push the scroll dial to turn the system on or off.

NOTE:

The system will retain current settings in the vehicle information display even if the e-POWER system is restarted.

ICC system limitations

WARNING

Listed below are the system limitations for the ICC system. Failure to operate the vehicle in accordance with these system limitations could result in serious injury or death:

- The ICC system is primarily intended for use on straight, dry, open roads with light

traffic. It is not advisable to use the ICC system in city traffic or congested areas.

- The ICC system will not adapt automatically to road conditions. This system should be used in evenly flowing traffic. Do not use the system on roads with sharp curves or on icy roads, in heavy rain or in fog.
- As there is a performance limit to the distance control function, never rely solely on the ICC system. This system does not correct careless, inattentive or absent-minded driving or overcome poor visibility in rain, fog, or other bad weather. Decelerate the vehicle speed by depressing the brake pedal, depending on the distance to the vehicle ahead and the surrounding circumstances in order to maintain a safe distance between vehicles.
- When the ICC system automatically brings the vehicle to a stop, your vehicle can automatically accelerate if the vehicle is stopped for less than approximately 3 seconds. Be prepared to stop your vehicle if necessary.
- Always check surroundings before restarting the vehicle.
- Always pay attention to the operation of the vehicle and be ready to manually control the proper following distance. The ICC system may not be able to maintain the selected distance between vehicles (following distance) or selected vehicle speed under some circumstances.

- The ICC system does not detect the following objects:
 - Stationary or slow moving vehicles (when your vehicle is approaching them)
 - Pedestrians or objects in the roadway
 - Oncoming vehicles in the same lane
 - Motorcycles travelling offset in the travel lane
- The ICC system may not detect a vehicle ahead in certain road, weather or driving conditions. To avoid accidents, never use the ICC system under the following conditions:
 - On roads with heavy, high-speed traffic or sharp curves
 - On slippery road surfaces such as on ice or snow, etc.
 - On a bumpy road surface, such as an uneven dirt road
 - On steep downhill roads (the vehicle may go beyond the vehicle set speed and frequent braking may result in overheating the brakes)
 - On repeated uphill and downhill roads
 - During bad weather (rain, fog, snow, etc.)
 - When the sensor detection is reduced (conditions such as rain, snow, fog, dust storms, sandstorms, and road spray from other vehicles)

- When dirt, ice, snow or other material adhere to the radar sensor area
- When traffic conditions make it difficult to keep a proper distance between vehicles because of frequent acceleration or deceleration
- When a complicated-shaped vehicle such as a car carrier trailer or flatbed truck/trailer is near the vehicle ahead
- When there is interference by other radar sources
- When excessively heavy baggage is loaded in the rear seat or cargo area of your vehicle
- Do not use the ICC system if you are towing a trailer or other vehicle. The system may not detect a vehicle ahead.
- In some road or traffic conditions, a vehicle or object can unexpectedly come into the sensor detection zone and cause automatic braking. Always stay alert and avoid using the ICC system where not recommended in this warning section.
- The ICC system also uses a multi-sensing front camera. The following are some conditions in which the camera may not properly detect a vehicle and detection of a vehicle ahead may be delayed:
 - Poor visibility (conditions such as rain, snow, fog, dust storms, sandstorms, and road spray from other vehicles)
 - The camera area of the windscreen is

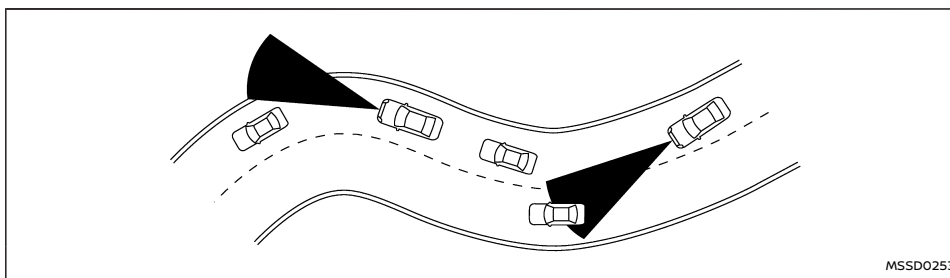
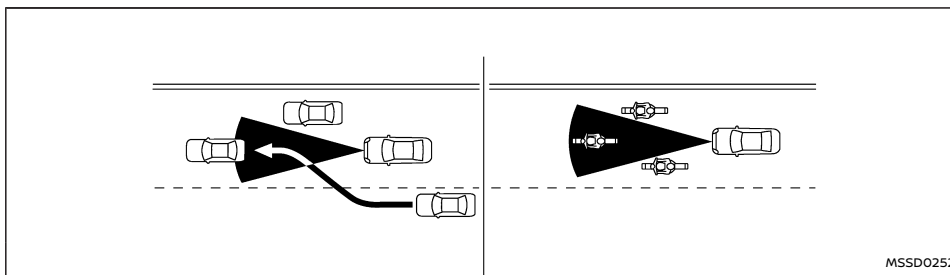
fogged up or covered with dirt, water drops, ice, snow, etc.

- Strong light (for example, sunlight or high beams from oncoming vehicles) enters the front camera
- A sudden change in brightness occurs (for example, when the vehicle enters or exits a tunnel or shaded area or lightning flashes)

The ICC system is designed to automatically check the radar sensor's operation within the limitations of the system

The detection zone of the radar sensor is limited. A vehicle ahead must be in the detection zone for the ICC system to maintain the selected distance from the vehicle ahead. A vehicle ahead may move outside of the detection zone due to its position within the same lane of travel. Motorcycles may not be detected in the same lane ahead if they are travelling offset from the centre line of the lane. A vehicle that is entering the lane ahead may not be detected until the vehicle has completely moved into the lane.

If this occurs, the ICC system may warn you by blinking the system indicator and sounding the chime. The driver may have to manually control the proper distance away from the vehicle travelling ahead.



When driving on some roads, such as winding, hilly, curved, narrow roads, or roads which are under construction, the radar sensor may detect vehicles in a different lane, or may temporarily not detect a vehicle travelling ahead. This may cause the ICC system to decelerate or accelerate the vehicle.

The detection of vehicles may also be affected by vehicle operation (steering manoeuvre or travelling position in the lane, etc.) or vehicle condition.

If this occurs, the ICC system may warn you by blinking the system indicator and sounding the chime unexpectedly. You will have to manually control the proper distance away from the vehicle travelling ahead.

ICC system temporarily unavailable

The following are conditions in which the ICC system may be temporarily unavailable. In these instances, the ICC system may not cancel and may not be able to maintain the selected following distance from the vehicle ahead.

Condition A:

Under the following conditions, the ICC system is automatically cancelled. A chime will sound and the system will not be able to be set:

- Any door is open.
- The driver's seat belt is unfastened.
- The vehicle ahead is not detected and your vehicle is travelling below the speed of 25 km/h (15 MPH). For ProPILOT Assist with Navilink equipped vehicles on a limited access freeway as identified in the navigation map data, the ICC system cancels and a warning chime sounds if your vehicle is at a standstill for more than approximately 3 seconds and a vehicle is not detected ahead.
- Your vehicle has been stopped by the ICC system for approximately 3 minutes or longer.
- The shift lever is moved out of the D (Drive) position.
- The electronic parking brake is applied.
- The ESP system is turned off.
- The Intelligent Emergency Braking with Pedestrian Detection system applies harder braking.
- ProPILOT Park (where fitted) is activated.
- ESP (including the traction control system) operates.

- The [SNOW] mode or [OFF-ROAD] mode is selected (4WD models).
- A wheel slips.
- When the front radar is impaired due to dirt or an other obstruction blocking the radar sensor.
- When the radar signal is temporarily interrupted.

Action to take:

When the conditions listed above are no longer present, turn the system off using the ProPILOT Assist switch. Turn the ProPILOT Assist system back on to use the system.

NOTE:

When the ICC system is cancelled under any of the following conditions at a standstill, the electronic parking brake is automatically activated:

- **Any door is open.**
- **The driver's seat belt is unfastened.**
- **Your vehicle has been stopped by the ICC system for approximately 3 minutes or longer.**
- **The shift lever is moved out of the D (Drive) position.**
- **The ESP system is turned off.**
- **When the front radar is impaired due to dirt or an other obstruction blocking the radar sensor.**
- **When the radar signal is temporarily interrupted.**

Condition B:

When there is inclement weather (rain, fog, snow, etc.) blocking the front radar sensor, the ICC system will automatically be cancelled, the chime will sound and the [Temporarily Disabled Front Radar Blocked] warning message will appear in the vehicle information display.

Action to take:

When the above condition is no longer present, the warning message will no longer be available in the vehicle information display and the system will operate normally. If the warning message continues to appear, have the system checked. It is recommended that you visit a NISSAN dealer or qualified workshop for this service.

Condition C:

When the radar sensor on the front of the vehicle is covered with dirt or is obstructed, the ICC system will automatically be cancelled.

The chime will sound and the [Temporarily Disabled Front Radar Blocked] warning message will appear in the vehicle information display.

Action to take:

If the warning message appears, stop the vehicle in a safe place, push the P position switch to engage the P (Park) position, and turn the e-POWER system off. When the radar signal is temporarily interrupted, clean the sensor area and restart the e-POWER system. If the warning message continues to appear, have the system checked. It is recommended that you visit a NISSAN dealer or qualified workshop for this service.

Condition D:

When driving on roads with limited road structures or buildings (for example, long bridges, deserts, snow fields, driving next to long walls), the chime will sound and the [Temporarily Disabled Front Radar Blocked] warning message will appear in the vehicle information display.

Action to take:

When the above driving conditions no longer exist, turn the system back on.

ICC system malfunction

If the ICC system malfunctions, it will be turned off automatically, a chime will sound, the [System fault See Owner's Manual] warning message will appear and the speed control status warning (yellow) will illuminate.

Action to take:

If the warning illuminates, stop the vehicle in a safe place. Turn the e-POWER system off, restart the e-POWER system and set the ICC system again. If it is not possible to set the ICC system or the warning stays on, it may be a malfunction. Although the normal driving can be continued, the ICC system should be inspected. It is recommended that you visit a NISSAN dealer or qualified workshop for this service.

NOTE:

If the ICC system is temporarily unavailable, the conventional cruise control mode may still be used. For additional information, see "Conventional (fixed speed) cruise control mode" (P.336).

ICC sensor maintenance

The radar sensor is located on the front of the vehicle.

To keep the ICC system operating properly, be sure to observe the following:

- Always keep the sensor area clean.
- Do not strike or damage the areas around the sensor.
- Do not attach a sticker (including transparent material) or install an accessory near the sensor. This could cause failure or malfunction.
- Do not attach metallic objects near the sensor area (brush guard, etc.). This could cause failure or malfunction.
- Do not alter, remove, or paint the front bumper.

Before customising or restoring the front bumper, it is recommended that you visit a NISSAN dealer or qualified workshop.

For the radio approval numbers and information, see "Radio approval number and information" (P.466).

The camera sensor is located above the inside rearview mirror.

To keep the proper operation of the systems and prevent a system malfunction, be sure to observe the following:

- Always keep the windscreen clean.
- Do not attach a sticker (including transparent material) or install an accessory near the camera unit.

- Do not place reflective materials, such as white paper or a mirror, on the instrument panel. The reflection of sunlight may adversely affect the camera unit's capability of detecting the lane markers.
- Do not strike or damage the areas around the camera unit. Do not touch the camera lens or remove the screw located on the camera unit.

If the camera unit is damaged due to an accident, it is recommended that you visit a NISSAN dealer or qualified workshop.

Radio frequency statement:

For the other radio approval numbers and information, see "Common troubleshooting guide" (P.250).

STEERING ASSIST

WARNING

Failure to follow the warnings and instructions for proper use of the Steering Assist could result in serious injury or death.

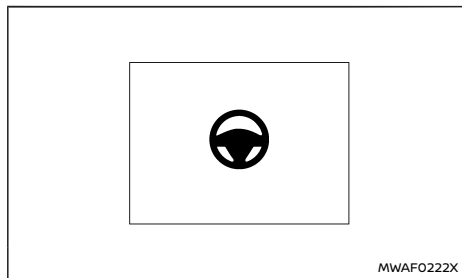
- **The Steering Assist is not a replacement for proper driving procedures and is not designed to correct careless, inattentive or absent-minded driving. The Steering Assist will not always steer the vehicle to keep it in the lane. It is not designed to prevent loss of control. It is the driver's responsibility to stay alert, drive safely, keep the vehicle in the travelling lane, and be in control of the vehicle at all times.**
- **As there is a performance limit to the Steering Assist's capability, never rely so-**

lely on the system. The Steering Assist does not function in all driving, traffic, weather, and road conditions. Always drive safely, pay attention to the operation of the vehicle, and manually control your vehicle appropriately.

- **The Steering Assist is intended for use on well-developed motorways or highways with gentle (moderate) curves, where traffic travelling in opposing directions is separated with a barrier. To avoid risk of an accident, do not use this system on local or non-highway or non-urban expressway roads.**
- **The Steering Assist only steers the vehicle to maintain its position in the centre of a lane. The vehicle will not steer to avoid objects in the road in front of the vehicle or to avoid a vehicle moving into your lane.**
- **It is the driver's responsibility to stay alert, drive safely, keep the vehicle in the travelling lane, and be in control of the vehicle at all times. Never take your hands off the steering wheel when driving. Always keep your hands on the steering wheel and drive your vehicle safely.**
- **Always drive carefully and attentively when using the Steering Assist. Read and understand the Owner's Manual thoroughly before using the Steering Assist. To avoid serious injury or death, do not rely on the system to prevent accidents or to control the vehicle's speed in emergency situations. Do not use the Steering Assist**

except in appropriate road and traffic conditions.

Steering Assist switch



The Steering Assist switch is used to temporarily turn on and off the Steering Assist system.

You can also use the [Driver Assistance] menu in the vehicle information display to turn on and off the Steering Assist system. (See "How to enable/disable the Steering Assist" (P.317).)

The Steering Assist system controls the steering system to help keep your vehicle near the centre of the lane when driving. (See "ProPILOT Assist (where fitted)" (P.309).)

Steering Assist operation

Steering Assist helps the driver keep the vehicle near the centre of the lane when both right and left lane markers are detected. Steering Assist only operates when combined with the Intelligent Cruise Control (ICC) system. For additional infor-

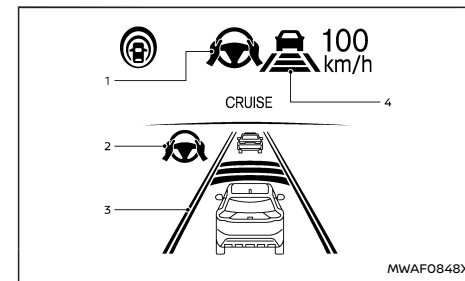
mation, see "Intelligent Cruise Control (ICC)" (P.319).

The Steering Assist can be activated when the following conditions are met:

- The ICC system is activated.
- Lane markers on both sides are clearly detected.
- Your vehicle is travelling at speed over 60 km/h (37 MPH), or a vehicle is detected in front of you when travelling under 60 km/h (37 MPH).
- The driver grips the steering wheel.
- The vehicle is driven at the centre of the lane.
- The turn signals are not operated.
- The windscreen wiper is not operated in the high speed position (the Steering Assist function is disabled after the wiper operates for approximately 10 seconds in the high speed position).

To enable or disable the Steering Assist, see "How to enable/disable the Steering Assist" (P.317).

Steering Assist display and indicators



Example

1. Steering Assist status indicator/warning

Displays the status of the Steering Assist by the colour of the indicator/warning

- No Steering Assist status indicator displayed: Steering Assist is turned off
- Steering Assist status indicator (grey): Steering Assist standby
- Steering Assist status indicator (green): Steering Assist active
- Steering Assist status indicator (yellow): Steering Assist malfunction
- Steering Assist status indicator (red): Hands off detected

2. Steering Assist indicator

Indicates the status of the Steering Assist by the colour of the indicator

- Steering Assist indicator (grey): Steering Assist standby
- Steering Assist indicator (green): Steering Assist active

3. Lane marker indicator

Indicates whether the system detects the lane marker

- Lane marker indicator (grey): Lane markers not detected
- Lane marker indicator (green): Lane markers detected
- Lane marker indicator (yellow): Lane departure is detected

4. Lane marker indicator/speed control status indicator/set distance indicator

Displays the status of the Steering Assist by the colour of the lane marker indicator.

Lane marker indicator (no lane): Steering Assist is turned off

- Lane marker indicator (grey): Steering Assist standby
- Lane marker indicator (green): Steering Assist active

For the speed control status indicator and set distance indicator, see "ProPILOT Assist system display and indicators" (P.313).

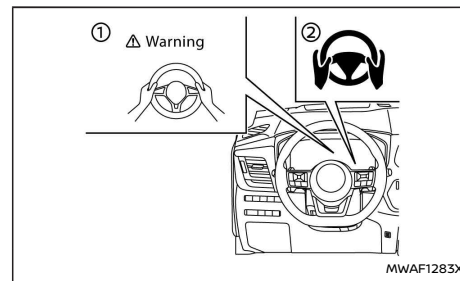
When the Steering Assist is in operation, the Steering Assist status indicator ①, the Steering Assist indicator ②, and the lane marker indicator ③ and ④ on the vehicle information display turn green.

When the Steering Assist deactivates, the Steering Assist status indicator ①, the Steering Assist indicator ②, and the lane marker indicator ③ and ④ on the vehicle information display turn grey and a chime sounds twice.

Emergency Lane Assist (ELA) (where fitted)

When a curve or strong cross wind exceeds the capabilities of the Steering Assist and your vehicle approaches either the left or the right side of the travelling lane, the steering wheel vibrates, a chime sounds and the ELA indicator (yellow) on the vehicle information display flashes. Then, the ELA system automatically applies the brakes for a short period of time to help assist the driver to avoid departing the lane and to return the vehicle to the centre of the travelling lane. This action is in addition to any Steering Assist actions and the warnings cannot be turned off. For more information, see "Emergency Lane Assist (ELA) (where fitted)" (P.263).

Hands on detection



When the Steering Assist is activated, it monitors the driver's steering wheel operation.

If the steering wheel is not operated or the driver takes his/her hands off the steering wheel for a period of time, the warning ① appears in the vehicle information display and the hands OFF warning light ② illuminates.

If the driver does not operate the steering wheel after the warning has been displayed and the warning light illuminated, an audible alert sounds and both the warning and the warning light flash. If the driver still does not operate the steering wheel, the system applies a momentary brake application to request the driver to take control of the vehicle again.

If the driver still does not respond, the system turns on the hazard flasher and slows the vehicle to a complete stop.

The driver can cancel the deceleration at any time by steering, braking, accelerating, or operating the ProPILOT Assist switch.

⚠ WARNING

Steering Assist is not a system for a hands-free driving. Always keep your hands on the steering wheel and drive your vehicle safely. Failure to do so could cause a collision resulting in serious personal injury or death.

NOTE:

The sensors may not detect the driver's hand(s) on the steering wheel in the following situations and a sequence of warnings may occur:

- Driving with gloves.
- Protective covers on the steering wheel.
- Gripping the part of the steering wheel without sensors, including leather joints and spokes.

Steering Assist limitations

WARNING

- In the following situations, the camera may not detect lane markers correctly or may detect lane markers incorrectly and the Steering Assist may not operate properly:
 - When driving on roads where there are multiple parallel lane markers, lane markers that are faded or not painted clearly, non-standard lane markers, or lane markers covered with water, dirt, snow, etc.
 - When driving on roads with discontinued lane markers
 - When driving on roads with a widening or narrowing lane width
 - When driving on roads where there are multiple lanes or unclear lane markers due to road construction
 - When driving on roads where there are sharply contrasting objects, such as shadows, snow, water, wheel ruts, seams, or lines remaining after road repairs (the Steering Assist could detect these items as lane markers)

- When driving on roads where the travelling lane merges or separates
- Do not use the Steering Assist under the following conditions because the system may not properly detect lane markers. Doing so could cause a loss of vehicle control and result in an accident.
 - During bad weather (rain, fog, snow, dust, etc.)
 - When rain, snow, sand, etc., is thrown up by the wheels of other vehicles
 - When dirt, oil, ice, snow, water, or another object adheres to the camera unit
 - When the lens of the camera unit is foggy
 - When strong light (for example, sunlight or high beams from oncoming vehicles) shines on the camera
 - When the headlights are not bright due to dirt on the lens or the headlights are off in tunnels or darkness
 - When a sudden change in brightness occurs (for example, when the vehicle enters or exits a tunnel or is under a bridge)
 - When driving on roads where the travelling lane merges or separates or where there are temporary lane markers because of road construction
 - When there is a lane closure due to road repairs

- When driving on a bumpy road surface, such as an uneven dirt road
- When driving on sharp curves or winding roads
- When driving on repeated uphill and downhill roads
- Do not use the Steering Assist under the following conditions because the system will not operate properly:
 - When driving with a tyre that is not within normal tyre conditions (for example, tyre wear, abnormal tyre pressure, tyre chains, non-standard wheels)
 - When the vehicle is equipped with non-original brake or suspension parts
 - When an object such as a sticker or cargo obstructs the camera
 - When excessively heavy baggage is loaded in the rear seat or luggage area of your vehicle
 - When the vehicle load capacity is exceeded
 - When towing a trailer or other vehicle
- Excessive noise will interfere with the warning chime sound, and the beep may not be heard.
- For the ProPILOT Assist system to operate properly, the windscreen in front of the camera must be clean. Replace worn wiper blades. The correct size wiper blades must

be used to help make sure the windscreen is kept clean. Only use Genuine NISSAN wiper blades, or equivalent wiper blades, that are specifically designed for use on your vehicle model and model year. It is recommended that you visit your NISSAN dealer or qualified workshop for the correct parts for your vehicle.

Steering Assist temporary standby

Automatic standby due to driving operation:

When the driver activates the turn signal, the Steering Assist is temporarily placed in a standby mode. (The Steering Assist restarts automatically when the operating conditions are met again.)

Automatic standby:

In the following cases, a double chime sounds and the Steering Assist is placed in a temporary standby mode. (The Steering Assist restarts automatically when the operating conditions are met again.)

- When the current travelling lane is too narrow to operate
- When a corner is too tight and the vehicle cannot stay in the travelling lane
- When lane markers on both sides are no longer detected
- When a vehicle ahead is no longer detected under approximately 60 km/h (37 MPH)
- When strong light enters the camera unit (For example, the light directly shines on the front of the vehicle at sunrise or sunset)

- When the temperature of the camera is too high

NOTE:

For vehicles equipped with ProPILOT Assist with Navi-link on a limited access freeway as identified in the navigation map data, the Steering Assist may continue to operate with visible lane markers on both sides even when the vehicle speed is below approximately 60 km/h (37 MPH) and a vehicle is not detected ahead.

Steering Assist cancel

Under the following conditions, the Steering Assist cancels, the chime sounds twice, the warning message appears, and the Steering Assist status indicator and the Steering Assist indicator turn off:

- When unusual lane markers appear in the travelling lane or when the lane marker cannot be correctly detected for some time due to certain conditions (for example, a snow rut, the reflection of light on a rainy day, the presence of several unclear lane markers)
- When the windscreen wiper operates in the high speed operation (the Steering Assist is disabled when the wiper operates for more than approximately 10 seconds)

Action to take:

When the conditions listed above are no longer present, turn Steering Assist on again using the Steering Assist switch.

Steering Assist malfunction

When the system malfunctions, it turns off automatically. The Steering Assist status warning (yellow) illuminates and the [System fault See Owner's Manual] warning message will appear in the vehicle information display. A chime may sound depending on the situation.

Action to take:

Stop the vehicle in a safe location, push the P position switch to shift to the P (Park) position, turn the e-POWER system off, restart the e-POWER system, resume driving, and set the ICC system again. If the warning (yellow) continues to illuminate, the Steering Assist is malfunctioning. Although the vehicle is still drivable under normal conditions, have the system checked. It is recommended that you visit a NISSAN dealer or qualified workshop for this service.

Steering Assist maintenance

The camera is located above the inside rearview mirror.

To keep the proper operation of the system and prevent a system malfunction, be sure to observe the following:

- Always keep the windscreen clean.
- Do not attach a sticker (including transparent material) or install an accessory near the camera unit.
- Do not place reflective materials, such as white paper or a mirror, on the instrument panel. The reflection of sunlight may adversely affect

the camera unit's capability of detecting the lane markers.

- Do not strike or damage the areas around the camera unit. Do not touch the camera lens or remove the screw located on the camera unit.

If the camera unit is damaged due to an accident, it is recommended that you visit a NISSAN dealer or qualified workshop.

For additional information, see "Common troubleshooting guide" (P.250).

CONVENTIONAL (fixed speed) CRUISE CONTROL MODE

NOTE:

ProPILOT Assist provides no approach warnings, automatic braking, or Steering Assist in the conventional (fixed speed) cruise control mode.

This mode allows driving at a speed above approximately 30 km/h (20 MPH) without keeping your foot on the accelerator pedal.

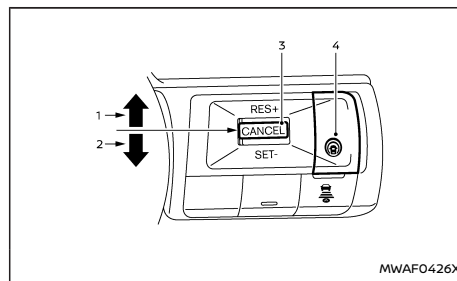
WARNING

- **In the conventional (fixed speed) cruise control mode, a warning chime does not sound to warn you if you are too close to the vehicle ahead, as neither the presence of the vehicle ahead nor the vehicle-to-vehicle distance is detected.**
- **Pay special attention to the distance between your vehicle and the vehicle ahead of you or a collision could occur.**
- **Always confirm the setting in the ICC system display.**
- **Do not use the conventional (fixed speed)**

cruise control mode when driving under the following conditions:

- **When it is not possible to keep the vehicle at a set speed**
 - **In heavy traffic or in traffic that varies in speed**
 - **On winding or hilly roads**
 - **On slippery roads (rain, snow, ice, etc.)**
 - **In very windy areas**
- **Doing so could cause a loss of vehicle control and result in an accident.**

Conventional (fixed speed) cruise control switches



1. RES+ operation:
Resumes vehicle set speed or increases speed incrementally
2. SET- operation:
Sets desired cruise speed or reduces speed incrementally

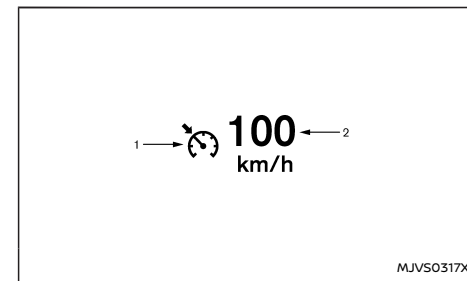
3. <CANCEL> switch:

Deactivates the system without erasing the vehicle set speed

4. ProPILOT Assist switch:

Turns the system on or off

Conventional (fixed speed) cruise control mode display and indicators



The display is located in the vehicle information display.

1. Cruise indicator:

This indicator indicates the condition of the ICC system depending on a colour.

- Cruise control ON indicator (grey): Indicates that the ProPILOT Assist switch is on
- Cruise control SET indicator (green): Indicates that the cruising speed is set
- Cruise control warning (yellow): Indicates that there is a malfunction in the ICC system

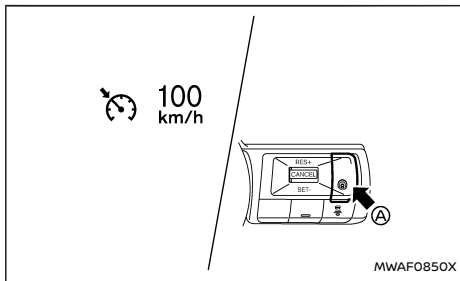
2. Vehicle set speed indicator:

This indicator indicates the vehicle set speed.

- Green: Cruise control active
- Grey: Cruise control standby

(The speed unit can be converted between [km/h] and [MPH] (where fitted). See "Unit/Language" (P.100).)

Operating conventional (fixed speed) cruise control mode



To turn on the conventional (fixed speed) cruise control mode, push and hold the ProPILOT Assist switch (A) for longer than about 1.5 seconds.

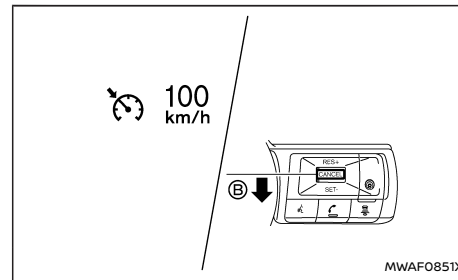
When pushing the ProPILOT Assist switch on, the ICC system display and indicators are displayed in the vehicle information display. After you hold the ProPILOT Assist switch on for longer than about 1.5 seconds, the ICC system display turns off. The cruise indicator appears. You can now set your desired cruising speed. Pushing the ProPILOT Assist switch again will turn the system completely off. When the power switch is placed in the OFF

position, the system is also automatically turned off.

To use the ICC system again, quickly push and release the ProPILOT Assist switch (vehicle-to-vehicle distance control mode) or push and hold it (conventional cruise control mode) again to turn it on.

⚠ WARNING

To avoid accidentally engaging cruise control, make sure to turn the ProPILOT Assist switch off when not using the ICC system.



Example

To set cruising speed, accelerate your vehicle to the desired speed, push down the <CANCEL> switch to SET- (B) and release it. (The colour of the cruise indicator changes to green and vehicle set speed indicator comes on.) Take your foot off the accelerator pedal. Your vehicle will maintain the set speed.

- To pass another vehicle, depress the accelerator pedal. When you release the pedal, the vehicle will return to the previously set speed.
- The vehicle may not maintain the set speed when going up or down steep hills. If this happens, manually maintain vehicle speed.

To cancel the preset vehicle speed, use any of the following methods:

- Push the <CANCEL> switch. The vehicle set speed indicator and the cruise indicator will turn grey.
- Tap the brake pedal. The vehicle set speed indicator and the cruise indicator will turn grey.
- Turn the ProPILOT Assist switch off. Both the cruise indicator and vehicle set speed indicator will turn off.

To reset at a faster cruising speed, use one of the following three methods:

- Depress the accelerator pedal. When the vehicle attains the desired speed, push down the <CANCEL> switch to SET- and release it.
- Push up and hold the <CANCEL> switch to RES+. When the vehicle attains the desired speed, release the switch.
- Push up the <CANCEL> switch to RES+ and then quickly release it. Each time you do this, the vehicle set speed will increase by about 1 km/h (1 MPH).

To reset at a slower cruising speed, use one of the following three methods:

- Lightly tap the brake pedal. When the vehicle

attains the desired speed, push down the **<CANCEL>** switch to SET- and release it.

- Push down and hold the **<CANCEL>** switch to SET-. Release the switch when the vehicle slows down to the desired speed.
- Push down the **<CANCEL>** switch to SET-, then quickly release it. Each time you do this, the vehicle set speed will decrease by about 1 km/h (1 MPH).

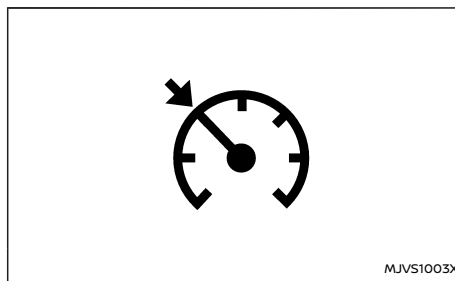
To resume the preset vehicle speed, push up the **<CANCEL>** switch to RES+ and release it. The vehicle will resume the last set cruising speed when the vehicle speed is over 30 km/h (20 MPH).

System temporarily unavailable

A chime sounds under the following conditions and the control is automatically cancelled.

- When the shift lever is not in the D (Drive) position
- When the parking brake is applied
- When the ESP system (including the traction control system) operates
- When the ESP system is turned off
- When a wheel slips

Warning



When the system is not operating properly, the chime sounds and the colour of the cruise indicator will change to yellow.

Action to take:

If the colour of the cruise indicator changes to yellow (cruise control warning), park the vehicle in a safe place. Turn the e-POWER system off, restart the e-POWER system, resume driving and then perform the setting again.

If it is not possible to set or the indicator stays on, it may indicate that the system is malfunctioning. Although the vehicle is still driveable under normal conditions, have the vehicle checked. It is recommended you visit a NISSAN dealer or qualified workshop for this service.

INTELLIGENT EMERGENCY BRAKING WITH PEDESTRIAN DETECTION SYSTEM

WARNING

Failure to follow the warnings and instructions for proper use of the Intelligent Emergency Braking with Pedestrian Detection system could result in serious injury or death.

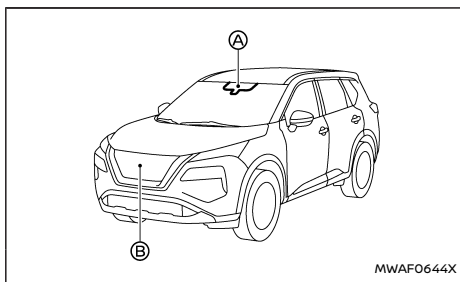
- **The Intelligent Emergency Braking with Pedestrian Detection system is a supplemental aid to the driver. It is not a replacement for the driver's attention to traffic conditions or responsibility to drive safely. It cannot prevent accidents due to carelessness or dangerous driving techniques.**
- **The Intelligent Emergency Braking with Pedestrian Detection system does not function in all driving, traffic, weather and road conditions.**

The Intelligent Emergency Braking with Pedestrian Detection system can assist the driver when there is a risk of a forward collision with:

- a vehicle ahead in the lane
- a pedestrian ahead in the lane
- a cyclist ahead in the lane (where fitted)

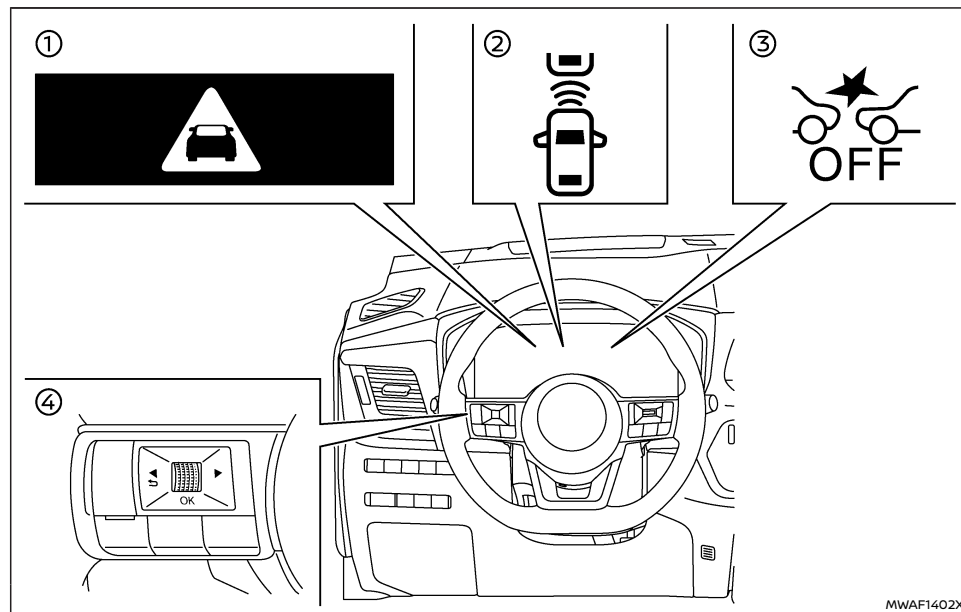
Junction assist (where fitted) can assist the driver when there is a risk of a forward collision:

- When you turn right or left and cross the path of an oncoming vehicle.
- When you turn right or left, a pedestrian is detected in the forward direction and is expected to enter your path.



The Intelligent Emergency Braking with Pedestrian Detection system uses a radar sensor **B** located on the front of the vehicle to measure the distance to the vehicle ahead in the same lane.

For pedestrians and cyclists, the Intelligent Emergency Braking with Pedestrian Detection system uses a camera **A** installed behind the windshield in addition to the radar sensor.



- ① Intelligent Emergency Braking emergency warning indicator
- ② Vehicle ahead detection indicator (on the vehicle information display)
- ③ Intelligent Emergency Braking system OFF warning light (on the meter panel)
- ④ Steering-wheel-mounted controls (left side)

INTELLIGENT EMERGENCY BRAKING WITH PEDESTRIAN DETECTION SYSTEM OPERATION

The Intelligent Emergency Braking with Pedestrian Detection system will function when your vehicle is driven at speeds above approximately 5 km/h (3 MPH).

For the pedestrian and cyclists detection function, the Intelligent Emergency Braking with Pedestrian

Detection system operates at the following speed range:

- 10 to 80 km/h (6 to 50 MPH)

If a risk of a forward collision is detected, the Intelligent Emergency Braking with Pedestrian Detection system will firstly provide the warning to the driver by flashing the vehicle ahead detection indicator (yellow) in the vehicle information display and providing an audible alert. In addition, the system applies partial braking.

If the driver applies the brakes quickly and forcefully after the warning, and the Intelligent Emergency Braking with Pedestrian Detection system detects that there is still the possibility of a forward collision, the system will automatically increase the braking force.

If the driver does not take action, the Intelligent Emergency Braking with Pedestrian Detection system issues the second visual (flashing) (red) and audible warning. Then the system applies partial braking.

If the risk of a collision becomes imminent, the Intelligent Emergency Braking with Pedestrian Detection system applies harder braking automatically.

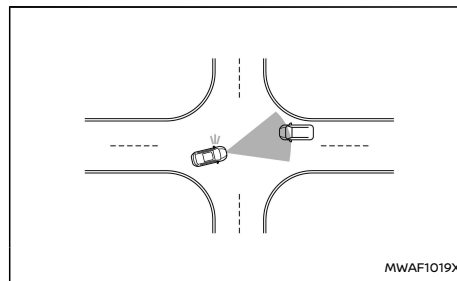
While the Intelligent Emergency Braking with Pedestrian Detection system is operating, you may hear the sound of brake operation. This is normal and indicates that the Intelligent Emergency Braking with Pedestrian Detection system is operating properly.

NOTE:

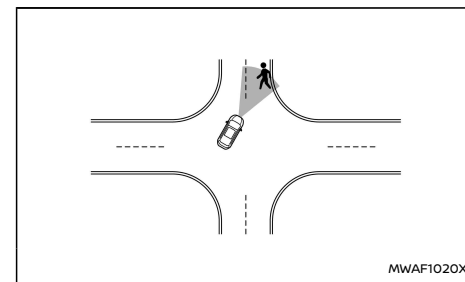
The vehicle's brake lights come on when braking is performed by the Intelligent Emergency Braking with Pedestrian Detection system.

Junction assist (where fitted) can operate at vehicle speeds between 10 - 25 km/h (6 -16 MPH).

The turn signal must be activated for junction assist to detect an approaching vehicle. However, junction assist may detect a pedestrian without the turn signal activated.



Junction assist for approaching vehicle



Junction assist for pedestrian

NOTE:

- **The vehicle's brake lights come on when braking is performed by the junction assist.**
- **When the Intelligent Emergency Braking with Pedestrian Detection system detects an obstacle in the path of the vehicle and displays the Intelligent Emergency Braking warning, a noise may be heard from the front of the vehicle as the vehicle primes the brakes to improve response time.**

Depending on vehicle speed and distance to the vehicle, pedestrian or cyclist ahead, as well as driving and roadway conditions, the system may help the driver avoid a forward collision or may help mitigate the consequences of a collision should one be unavoidable.

If the driver is handling the steering wheel, accelerating or braking, the Intelligent Emergency Braking with Pedestrian Detection system will function later or will not function.

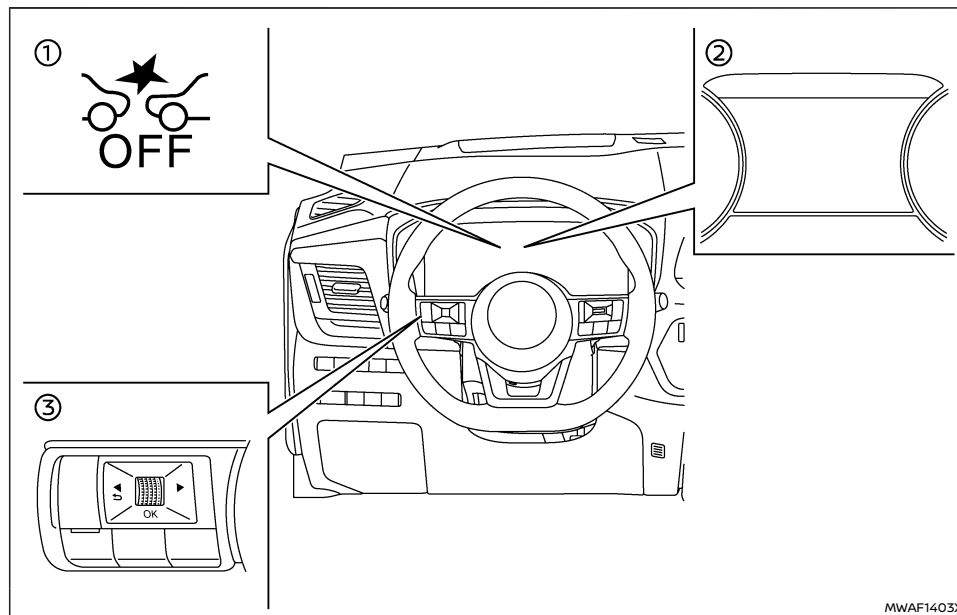
The automatic braking will cease under the following conditions:

- When the steering wheel is turned as far as necessary to avoid a collision.
- When the accelerator pedal is depressed.
- When there is no longer a vehicle, pedestrian or cyclist detected ahead.

If the Intelligent Emergency Braking with Pedestrian Detection system has stopped the vehicle, the vehicle will remain at a standstill for approximately 2 seconds before the brakes are released.

When the brake pedal is depressed while the brake is applied by the system, you may feel the pedal effort is changed and may hear a sound and vibration noise. This is normal and does not indicate a malfunction. In addition, the braking force can be increased by adding the pedal effort.

TURNING THE INTELLIGENT EMERGENCY BRAKING WITH PEDESTRIAN DETECTION SYSTEM ON/OFF



- ① Intelligent Emergency Braking system OFF warning light (on the meter panel)
- ② Vehicle information display
- ③ Steering-wheel-mounted controls (left side)

Perform the following steps to turn the Intelligent

Emergency Braking with Pedestrian Detection system on or off.

1. Push the ◀ ▶ button until [Settings] appears in the vehicle information display and then push the scroll dial. Use the scroll dial to select [Driver Assistance]. Then push the scroll dial.

2. Type A:

Select [Emergency Brake] and push the scroll dial. Then select [Front] and push the scroll dial to turn the system on or off.

Type B:

Select [Emergency Brake] and push the scroll dial to turn the system on or off.

When the Intelligent Emergency Braking with Pedestrian Detection system is turned off, the Intelligent Emergency Braking system OFF warning light illuminates.

NOTE:

- **Disabling the Electronic Stability Programme (ESP) system causes the Intelligent Emergency Braking with Pedestrian Detection system to become unavailable regardless of settings selected in the vehicle information display.**
- **The Intelligent Emergency Braking with Pedestrian Detection system will be automatically turned ON when the e-POWER system is restarted.**
- **The Intelligent Emergency Braking with Pedestrian Detection system cannot be turned on or off while driving.**
- **The Intelligent Forward Collision Warning system is integrated into the Intelligent Emergency Braking with Pedestrian Detection system. There is not a separate selection for the Intelligent Forward Collision Warning system. When the Intelligent Emergency Braking with Pedestrian Detection**

system is turned off, the Intelligent Forward Collision Warning system is also turned off.

INTELLIGENT EMERGENCY BRAKING WITH PEDESTRIAN DETECTION SYSTEM LIMITATIONS

WARNING

Listed below are the system limitations for the Intelligent Emergency Braking with Pedestrian Detection system. Failure to operate the vehicle in accordance with these system limitations could result in serious injury or death.

- **The Intelligent Emergency Braking with Pedestrian Detection system cannot detect all vehicles, pedestrians or cyclists under all conditions.**
- **The Intelligent Emergency Braking with Pedestrian Detection system does not detect the following:**
 - Pedestrians that are small (for example, children), in a sitting position, operating toys/skateboards, on scooters or in wheelchairs, or not in an upright standing or walking position.
 - Animals of any size.
 - Obstacles (for example, cargo or debris) on the roadway or roadside.
 - Crossing vehicles.
 - Vehicles where the tyres are difficult to see or the shape of the rear of the vehicle is unclear or obstructed.
 - Parked vehicles.

- **The Intelligent Emergency Braking with Pedestrian Detection system has some performance limitations.**

- **If a stationary vehicle is in the vehicle's path, the system will not function when the vehicle approaches the stationary vehicle at the following speeds:**

Approximately 100 km/h (62 MPH) and above

- **Pedestrian and cyclist detection will not function when the vehicle is driven at the following speeds:**

Over approximately 80 km/h (50 MPH) or below approximately 10 km/h (6 MPH)

- **For pedestrians, the Intelligent Emergency Braking with Pedestrian Detection system will not issue the first warning.**
- **The Intelligent Emergency Braking with Pedestrian Detection system may not function properly or detect a vehicle, pedestrian or cyclist ahead in the following conditions:**
 - **In poor visibility conditions (such as rain, snow, fog, dust storms, sand storms, smoke, and road spray from other vehicles).**
 - **If dirt, ice, snow, fog or other material is covering the radar sensor area or camera area of the windscreen.**
 - **If strong light (for example, sunlight or high beams) enters the front camera**

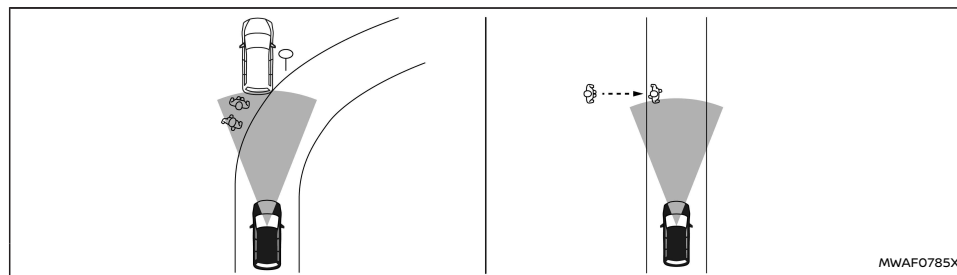
or a sudden change in brightness occurs (for example, entering a tunnel or driving in lightning).

- In dark or dimly lit conditions, such as at night or in tunnels, including cases where your vehicle's headlights are off or dim, or the tail lights of the vehicle ahead are off.
- When the direction of the camera is misaligned.
- When driving on a steep downhill slope, on roads with sharp curves, and/or bumpy or dirt roads.
- If there is interference by other radar sources.
- When your vehicle's position or movement is changed quickly or significantly (for example, lane change, turning vehicle, abrupt steering, sudden acceleration or deceleration).
- When your vehicle or the vehicle, pedestrian or cyclist ahead moves quickly or significantly such that the system cannot detect and react in time (for example, pedestrian moving quickly toward the vehicle at close range, vehicle cutting in, changing lanes, making a turn, steering abruptly, sudden acceleration or deceleration).
- When the vehicle, pedestrian or cyclist is offset from the vehicle's forward path.

- If the speed difference between the two vehicles is small.
- The pedestrian's profile is partially obscured or unidentifiable; for example, due to transporting luggage, pushing a stroller, wearing bulky or very loose-fitting clothing or accessories, or being in a unique posture (such as raising hands).
- There is poor contrast of a person to the background, such as having clothing colour or pattern which is similar to the background.
- For approximately 15 seconds after starting the e-POWER system.
- When the system has never detected an obstacle since the vehicle was driven after the e-POWER system was started.
- If the vehicle ahead has a unique or unusual shape, extremely low or high clearance heights, or unusual cargo loading or is narrow (for example, a motorcycle).
- When the vehicle, pedestrian or cyclist is located near a traffic sign, a reflective area (for example, water on road), or is in a shadow.
- When multiple pedestrians or cyclists are grouped together.
- When the view of the pedestrian or cyclist is obscured by a vehicle or other object.

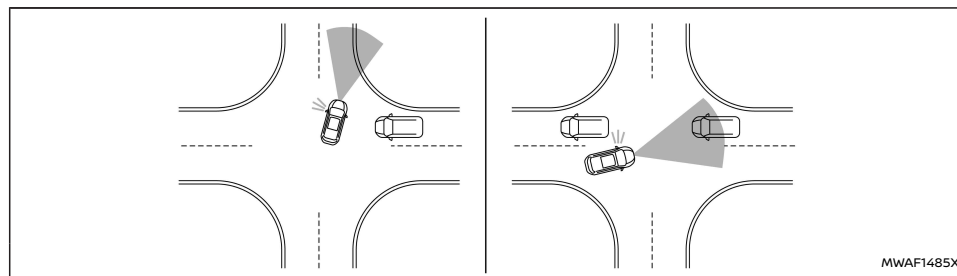
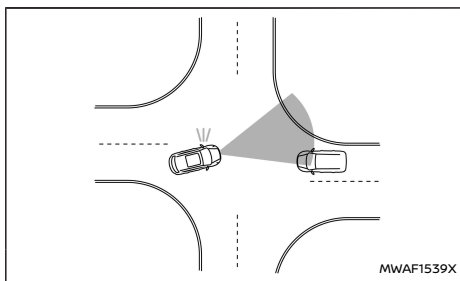
- While towing a trailer or other vehicle.
- The system performance may be degraded in the following conditions:
 - The vehicle is driven on a slippery road.
 - The vehicle is driven on a slope.
 - Excessively heavy baggage is loaded in the rear seat or the cargo area of your vehicle.
- The system is designed to automatically check the sensor's (radar and camera) functionality, within certain limitations. The system may not detect some forms of obstruction of the sensor area such as ice, snow or stickers, for example. In these cases, the system may not be able to warn the driver properly. Be sure that you check, clean and clear sensor areas regularly.
- In some road and traffic conditions, the Intelligent Emergency Braking with Pedestrian Detection system may unexpectedly apply partial braking. When acceleration is necessary, depress the accelerator pedal to override the system.
- The Intelligent Emergency Braking with Pedestrian Detection system may operate when a pattern, object, shadow or lights are detected that are similar to the outline of vehicles, pedestrians or cyclists, or if they are the same size and position as a vehicle or motorcycle's tail lights.
- The system may keep operating when the vehicle ahead is turning right or left.

- The system may operate when your vehicle is approaching and passing a vehicle ahead.
- Depending on the road shape (curved road, entrance and exit of the curve, winding road, lane regulation, under construction, etc.), the system may operate temporarily for the approaching vehicle in front of your vehicle.



⚠ WARNING

- The Intelligent Emergency Braking with Pedestrian Detection system may react to:
 - objects on the roadside (traffic sign, guardrail, pedestrian, cyclist, motorcycle, vehicle, etc.)
 - pedestrians or cyclists when driving on the narrow alleys, etc.
 - pedestrians or cyclists who temporarily protrude into or approaching the driving lane to avoid the obstacles on the road shoulder
 - objects above road (low bridge, traffic sign, etc.)
 - objects on the road surface (railroad track, grate, steel plate, etc.)
 - objects in the parking garage (beam, pillar, etc.)
 - pedestrians, cyclists or motorcycles approaching the travelling lane
- vehicles, pedestrians, cyclists, motorcycles or objects in adjacent lanes or close to the vehicle
- approaching pedestrians, cyclists
- objects on the road (such as trees)
- Braking distances increase on slippery surfaces.
- Excessive noise will interfere with the warning chime sound, and the chime may not be heard.



(In the junction) After turning left/Approaching vehicles in a row

⚠ WARNING

- Junction assist (where fitted) does not apply braking to approaching vehicles in front of your vehicle.

⚠ WARNING

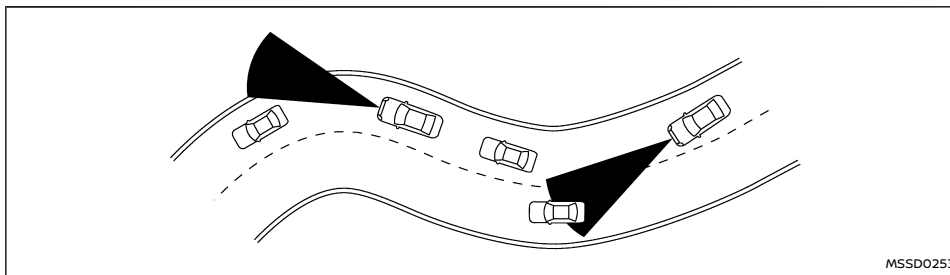
In addition to the system limitations that apply to the Intelligent Emergency Braking with Pedestrian Detection system, the following system limitations apply to the Intelligent Emergency Braking with Pedestrian Detection while junction assist (where fitted) is operating:

- Junction assist may not detect an approaching vehicle or pedestrian in the following conditions:
 - When driving in a traffic lane separated by more than 2 lanes from approaching vehicles while making a right/left turn.
 - When not heading directly towards an approaching vehicle during a right/left turn.
 - Junction assist may not detect an

approaching vehicle after you have already started your turn.

- When turning sharply or on a very wide curve.
- When the centre line is not recognised by the system.
- When there are a number of approaching vehicles following each other in a row.
- When the lane is wider or narrower than normal.
- When the centre line is located close to a road marker.
- Junction assist may apply braking while making a right/left turn even if the risk of a collision is low.
- Junction assist may also apply braking when approaching vehicle movement cannot be predicted due to sudden left/right

turns or deceleration of the approaching vehicles.



When driving on some roads, such as winding, hilly, curved, narrow roads, or roads which are under construction or on a slope, the sensor may detect vehicles in a different lane, or may temporarily not detect a vehicle travelling ahead. This may cause the system to work inappropriately.

The detection of vehicles may also be affected by vehicle operation (steering manoeuvre or travelling position in the lane, etc.) or vehicle condition. If this occurs, the system may warn you by blinking the system indicator and sounding the chime unexpectedly. You will have to manually control the proper distance away from the vehicle travelling ahead.

SYSTEM TEMPORARILY UNAVAILABLE

Condition A

In the following conditions, the Intelligent Emergency Braking system OFF warning light will illuminate and the [Temporarily Disabled Camera Blocked See Owner's Manual] warning message will appear in the vehicle information display. And the system will be turned off automatically.

- The camera area of the windscreen is covered with moisture, snow, ice, dirt or some other object.
- The camera area of the windscreen is continuously covered with dirt, etc.

Action to take:

Check that the windscreen is clean and free from ice/mist in front of the camera. If necessary, operate the Max defogging/defrosting function

or heated windscreen (where fitted) to clear. This may take several minutes.

When the above conditions no longer exist, the Intelligent Emergency Braking with Pedestrian Detection system will resume automatically.

Condition B

In the following conditions, the Intelligent Emergency Braking system OFF warning light will illuminate and the [Currently Unavailable Poor Visibility] warning message will appear in the vehicle information display.

- Strong light is shining onto the front of the vehicle.
- The camera area of the windscreen is fogged up or covered with dirt, water, drops, ice, snow, etc. temporarily.

Action to take:

When the above conditions no longer exist, the Intelligent Emergency Braking with Pedestrian Detection system will resume automatically.

Condition C

In the following condition, the Intelligent Emergency Braking system OFF warning light will illuminate and the [Currently Unavailable Front Camera High Temperature] warning message will appear in the vehicle information display.

- The cabin temperature is over approximately 40 °C (104 °F) in direct sunlight.

Action to take:

When the interior temperature is reduced, the

Intelligent Emergency Braking with Pedestrian Detection system will resume automatically.

Condition D

In the following conditions, the Intelligent Emergency Braking system OFF warning light will illuminate and the [Currently Unavailable] warning message will appear in the vehicle information display.

- When the system check for the warning function did not end normally.
- When the vehicle is towed.

Action to take:

When the above conditions no longer exist, the Intelligent Emergency Braking with Pedestrian Detection system will resume automatically.

Condition E

In the following condition, the Intelligent Emergency Braking system OFF warning light will illuminate and the [Currently Unavailable Radar Inhibited] warning message will appear in the vehicle information display.

- When the radar sensor picks up interference from another radar source.

Action to take:

When the above condition no longer exists, the Intelligent Emergency Braking with Pedestrian Detection system will resume automatically.

Condition F

In the following condition, the Intelligent Emergency Braking system OFF warning light will illuminate and the [Temporarily Disabled Front Radar Blocked See Owner's Manual] warning message will appear in the vehicle information display.

- The sensor area of the front of the vehicle is covered with dirt or is obstructed.

Action to take:

If the warning light illuminates, pull off the road to a safe location and stop the vehicle. Turn the e-POWER system off. Clean the radar cover on the front of the vehicle with a soft cloth, and restart the e-POWER system. If the warning light continues to illuminate, have the Intelligent Emergency Braking with Pedestrian Detection system checked. It is recommended you visit a NISSAN dealer or qualified workshop for this service.

Condition G

In the following condition, the Intelligent Emergency Braking system OFF warning light will illuminate and the [Temporarily Disabled Front Radar Blocked See Owner's Manual] warning message will appear in the vehicle information display.

- When driving on roads with limited road structures or buildings (for example, long bridges, deserts, snow fields, driving next to long walls).

Action to take:

When the above condition no longer exists, the

Intelligent Emergency Braking with Pedestrian Detection system will resume automatically.

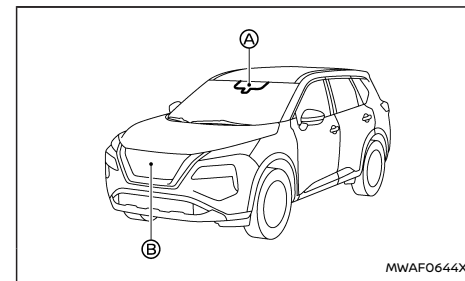
Condition H

When the Electronic Stability Programme (ESP) system is turned OFF, the Intelligent Emergency Braking system will not operate and the [Currently Unavailable ESP OFF] warning message will appear in the vehicle information display.

Action to take:

When the ESP system is ON, the Intelligent Emergency Braking with Pedestrian Detection system will resume automatically.

SYSTEM MAINTENANCE



The radar sensor (B) is located on the front of the vehicle. The camera (A) is located on the upper side of the windscreen.

To keep the Intelligent Emergency Braking with Pedestrian Detection system operating properly, be sure to observe the following:

INTELLIGENT FORWARD COLLISION WARNING (where fitted)

- Always keep the sensor area on the front of the vehicle and windscreen clean.
- Do not strike or damage the areas around the sensors (ex. bumper, windscreen).
- Do not cover or attach stickers or similar objects on the front of the vehicle near the sensor area. This could cause failure or malfunction.
- Do not attach metallic objects near the radar sensor area (brush guard, etc.). This could cause failure or malfunction.
- Do not place reflective materials, such as white paper or a mirror, on the instrument panel. The reflection of sunlight may adversely affect the camera unit's detection capability.
- Do not alter, remove or paint the front of the vehicle near the sensor area. Before customising or restoring the sensor area, it is recommended that you visit a NISSAN dealer or qualified workshop.

Radio frequency statement

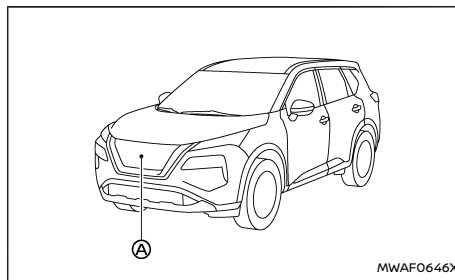
For the other radio approval numbers and information, see "Radio approval number and information" (P.466).


WARNING

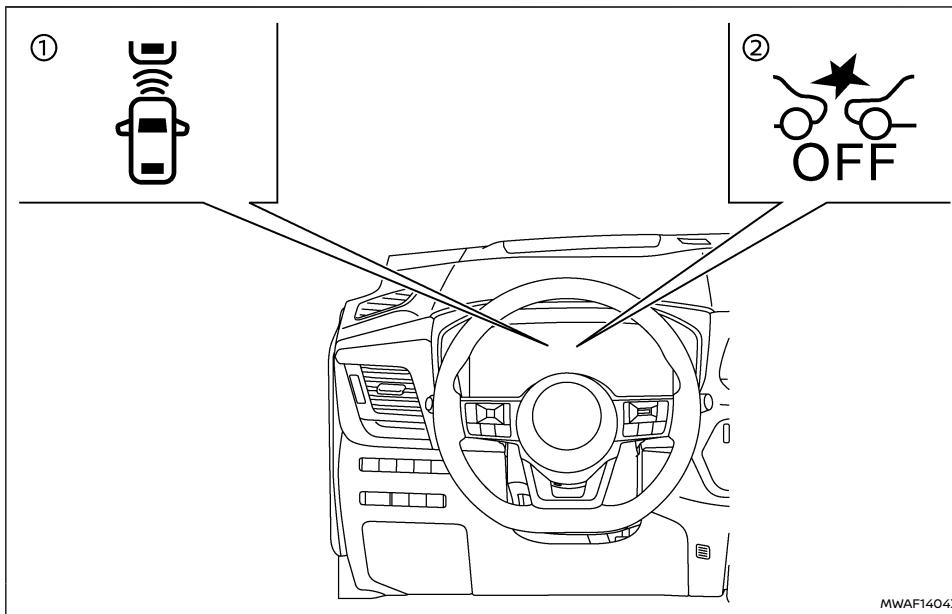
Failure to follow the warnings and instructions for proper use of the Intelligent Forward Collision Warning system could result in serious injury or death.

- **The Intelligent Forward Collision Warning system helps warn the driver before a collision but will not avoid a collision. It is the driver's responsibility to stay alert, drive safely and be in control of the vehicle at all times.**

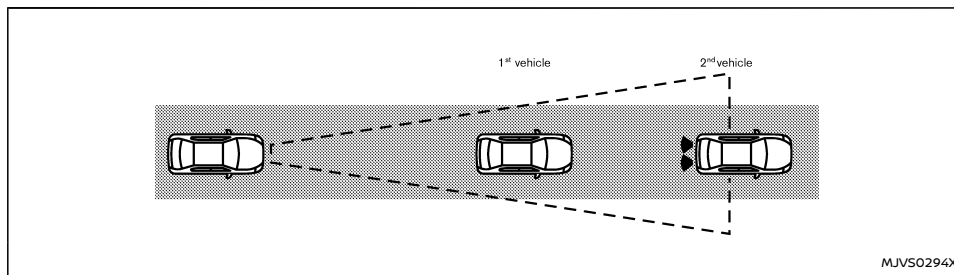
The Intelligent Forward Collision Warning system can help alert the driver when there is a sudden braking of a second vehicle travelling in front of the vehicle ahead in the same lane.



The Intelligent Forward Collision Warning system uses a radar sensor  located on the front of the vehicle to measure the distance to a second vehicle ahead in the same lane.



- ① Vehicle ahead detection indicator (on the vehicle information display)
- ② Intelligent Emergency Braking system OFF warning light (on the meter panel)

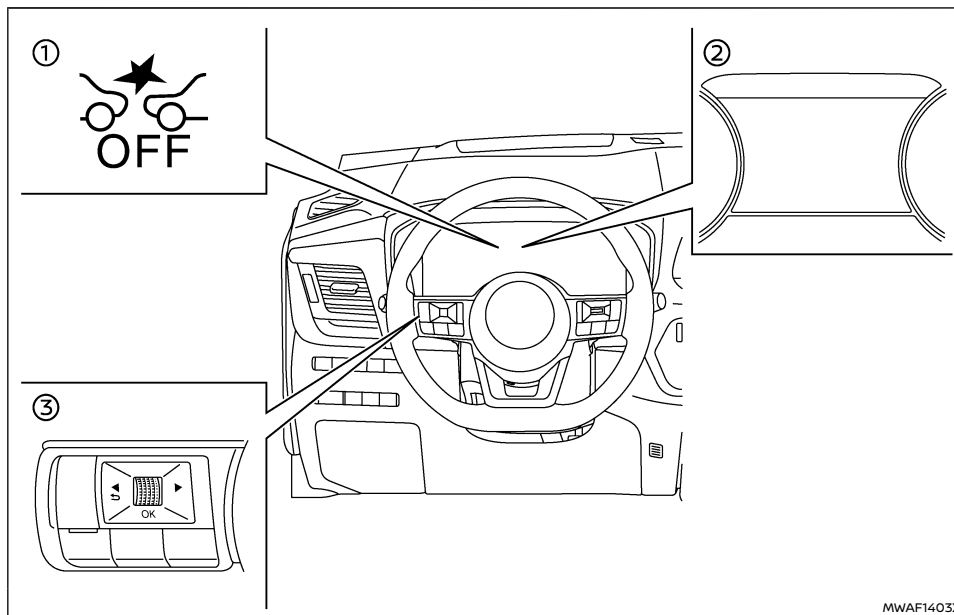


INTELLIGENT FORWARD COLLISION WARNING SYSTEM OPERATION

The Intelligent Forward Collision Warning system operates at speeds above approximately 5 km/h (3 MPH).

If there is a potential risk of a forward collision, the Intelligent Forward Collision Warning system will warn the driver by blinking the vehicle ahead detection indicator, and sounding an audible alert.

TURNING THE INTELLIGENT FORWARD COLLISION WARNING SYSTEM ON/OFF



- ① Intelligent Emergency Braking system OFF warning light (on the meter panel)
- ② Vehicle information display
- ③ Steering-wheel-mounted controls (left side)

Perform the following steps to turn the Intelligent Forward Collision Warning system on or off.

1. Push the ◀ ▶ button until [Settings] appears in the vehicle information display and then push the scroll dial. Use the scroll dial to select [Driver Assistance]. Then push the scroll dial.

2. Type A:

Select [Emergency Brake] and push the scroll dial. Then select [Front] and push the scroll dial to turn the system on or off.

- Type B:

Select [Emergency Brake] and push the scroll dial to turn the system on or off.

When the Intelligent Forward Collision Warning system is turned off, the Intelligent Emergency Braking system OFF warning light (yellow) illuminates.

NOTE:

- The Intelligent Forward Collision Warning system will be automatically turned on when the e-POWER system is restarted.
- The Intelligent Forward Collision Warning system is integrated into the Intelligent Emergency Braking with Pedestrian Detection system. There is not a separate selection for the Intelligent Forward Collision Warning system. When the Intelligent Emergency Braking with Pedestrian Detection system is turned off, the Intelligent Forward Collision Warning system is also turned off.
- The Intelligent Forward Collision Warning system cannot be turned on or off while driving (Type A).

INTELLIGENT FORWARD COLLISION WARNING SYSTEM LIMITATIONS

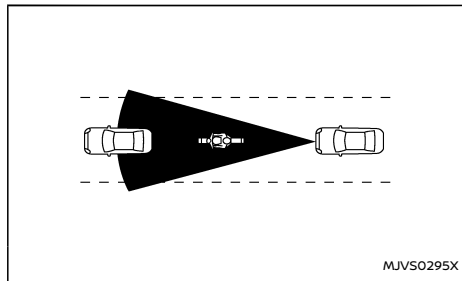


Illustration A

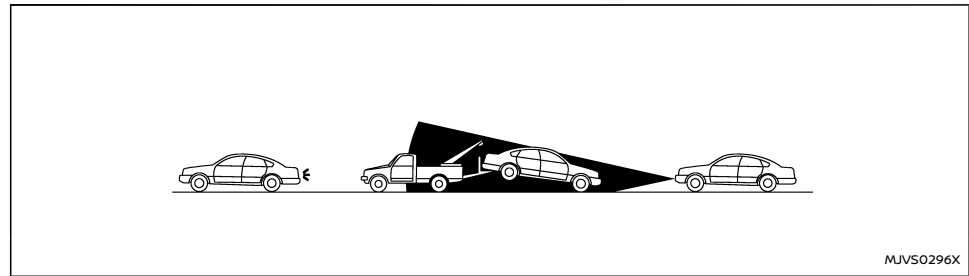


Illustration B

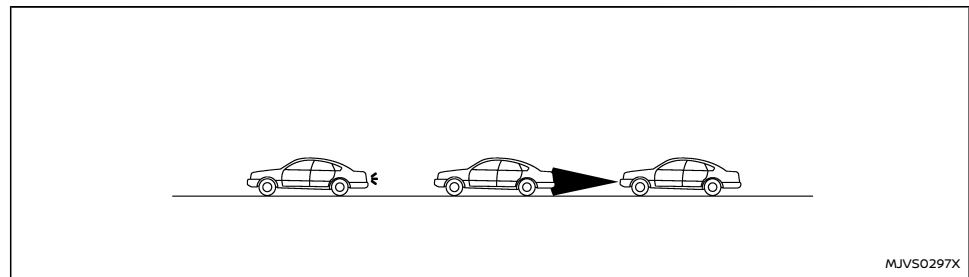


Illustration C

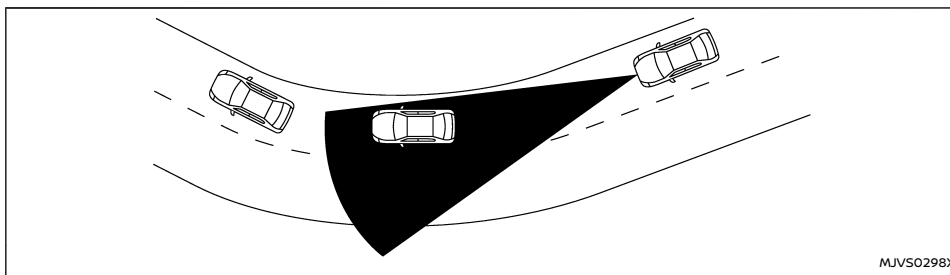


Illustration D

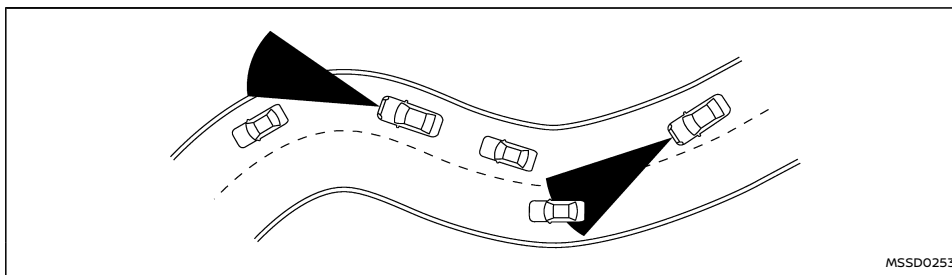
⚠ WARNING

Listed below are the system limitations for the Intelligent Forward Collision Warning system. Failure to operate the vehicle in accordance with these system limitations could result in serious injury or death.

- The Intelligent Forward Collision Warning system cannot detect all vehicles under all conditions.
- The radar sensor does not detect the following objects:
 - Pedestrians, animals or obstacles in the roadway
 - Oncoming vehicles
 - Crossing vehicles
- (Illustration A) The Intelligent Forward Collision Warning system does not function when a vehicle ahead is a narrow vehicle, such as a motorcycle.
- The radar sensor may not detect a vehicle ahead in the following conditions:
 - Snow or heavy rain
 - Dirt, ice, snow or other material covering the radar sensor
 - Interference by other radar sources
 - Snow or road spray from travelling vehicles.
 - Driving in a tunnel
 - Towing a trailer
- (Illustration B) When the vehicle ahead is being towed.
- (Illustration C) When the distance to the vehicle ahead is too close, the beam of the radar sensor is obstructed.
- (Illustration D) When driving on a steep downhill slope or roads with sharp curves.
- The system is designed to automatically check the sensor's functionality, within

certain limitations. The system may not detect some forms of obstruction of the sensor area such as ice, snow, stickers, for example. In these cases, the system may not be able to warn the driver properly. Be sure that you check, clean and clear the sensor area regularly.

- Excessive noise will interfere with the warning chime sound, and the chime may not be heard.



When driving on some roads, such as winding, hilly, curved, narrow roads, or roads which are under construction, the radar sensor may detect vehicles in a different lane, or may temporarily not detect a vehicle travelling ahead. This may cause the Intelligent Forward Collision Warning system to work inappropriately.

The detection of vehicles may also be affected by vehicle operation (steering manoeuvre or travelling position in the lane, etc.) or vehicle condition. **If this occurs, the system may warn you by blinking the vehicle ahead detection indicator and sounding the chime unexpectedly. You will have to manually control the proper distance away from the vehicle travelling ahead.**

SYSTEM TEMPORARILY UNAVAILABLE

Condition A

When the radar sensor picks up interference from another radar source, making it impossible to detect a vehicle ahead, the Intelligent Forward Collision Warning system is automatically turned off. The Intelligent Emergency Braking system OFF warning light (yellow) will illuminate and the [Currently Unavailable Radar Inhibited] warning message will appear in the vehicle information display.

Action to take:

When the above conditions no longer exist, the Intelligent Forward Collision Warning system will resume automatically.

Condition B

Under the following conditions, making it impossible to detect a vehicle ahead, the Intelligent Forward Collision Warning system is automatically turned off.

The Intelligent Emergency Braking system OFF warning light (yellow) will illuminate and the [Temporarily Disabled Front Radar Blocked See Owner's Manual] warning message will appear in the vehicle information display.

- When the sensor area of the front of the vehicle is covered with dirt or is obstructed

Action to take:

If the warning light (yellow) illuminate, stop the vehicle in a safe place, push the P position switch to engage the P (Park) position and turn the e-POWER system off. Clean the radar cover on the front of the vehicle with a soft cloth, and restart the e-POWER system. If the warning light continues to illuminate, have the Intelligent Forward Collision Warning system checked. It is recommended you visit a NISSAN dealer or qualified workshop for this service.

- When driving on roads with limited road structures or buildings (for example, long bridges, deserts, snow fields, driving next to long walls)

Action to take:

When the above conditions no longer exist, the Intelligent Forward Collision Warning system will resume automatically.

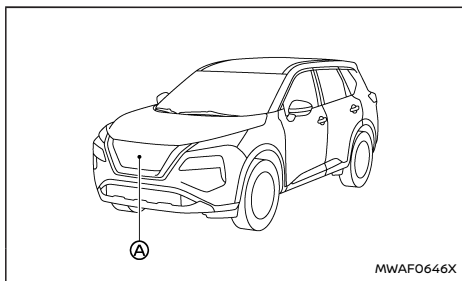
SYSTEM MALFUNCTION

If the Intelligent Forward Collision Warning system malfunctions, it will be turned off automatically, a chime will sound, the Intelligent Emergency Braking system OFF warning light (yellow) will illuminate and the [System fault See Owner's Manual] warning message will appear in the vehicle information display.

Action to take:

If the warning light (yellow) illuminates, stop the vehicle in a safe location. Turn the e-POWER system off and restart the e-POWER system. If the warning light continues to illuminate, have the Intelligent Forward Collision Warning system checked. It is recommended you visit a NISSAN dealer or qualified workshop for this service.

SYSTEM MAINTENANCE



The radar sensor (A) is located on the front of the vehicle.

To keep the system operating properly, be sure to observe the following:

- Always keep the sensor area on the front of the vehicle clean.
- Do not strike or damage the areas around the sensor.
- Do not cover or attach stickers or similar objects on the front bumper near the sensor area. This could cause failure or malfunction.
- Do not attach metallic objects near the sensor area (brush guard, etc.). This could cause failure or malfunction.
- Do not alter, remove or paint the front bumper. It is recommended you contact a NISSAN dealer or qualified workshop before customising or restoring the front bumper.

Radio frequency statement

For the other radio approval numbers and information, see "Radio approval number and information" (P.466).

INTELLIGENT DRIVER ALERTNESS (where fitted)

⚠ WARNING

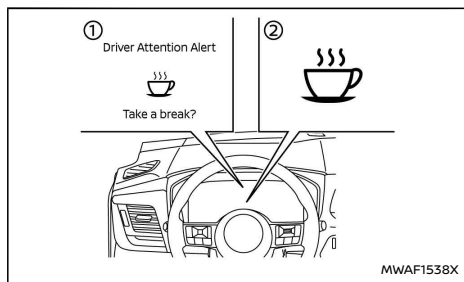
Failure to follow the warnings and instructions for proper use of the Intelligent Driver Alertness system could result in serious injury or death.

- **The Intelligent Driver Alertness system is only a warning to inform the driver of a potential lack of driver attention or drowsiness. It will not steer the vehicle or prevent loss of control.**
- **The Intelligent Driver Alertness system does not detect and provide an alert of the driver's lack of attention or fatigue in every situation.**
- **It is the driver's responsibility to:**
 - Stay alert.
 - Drive safely.
 - Keep the vehicle in the travelling lane.
 - Be in control of the vehicle at all times.
 - Avoid driving when tired.
 - Avoid distractions (texting, etc.).

The Intelligent Driver Alertness system helps alert the driver if the system detects a lack of attention or driving fatigue.

The system monitors driving style and steering behavior over a period of time, and it detects changes from the normal pattern. If the system detects that driver attention is decreasing over a period of time, the system uses audible and visual warnings to suggest that the driver take a break.

INTELLIGENT DRIVER ALERTNESS SYSTEM OPERATION



- ① Take a break? message (on the vehicle information display)
- ② Intelligent Driver Alertness indicator light (on the meter panel)

If the system detects driver fatigue or that driver attention is decreasing, the message [Take a break?] appears in the vehicle information display and a chime sounds when the vehicle is driven at speeds above 60 km/h (37 MPH).

In addition, the system operates as follows:

- When the system alerts the driver, the Intelligent Driver Alertness indicator light (white) will also illuminate.
- The chime will sound continuously.

To disable the warning, push the scroll dial on the steering wheel.

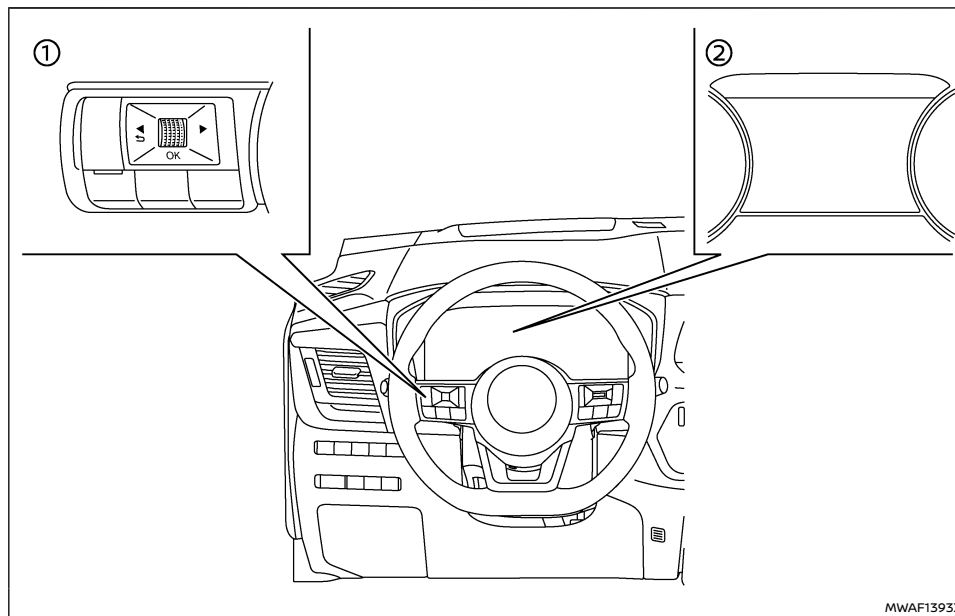
The system continuously monitors driver attention and can provide multiple warnings per trip.

The system resets and starts reassessing driving

style and steering behavior when the power switch is cycled from the ON to the OFF position and back to the ON position.

The system will not operate when Steering Assist system (where fitted) is activated.

HOW TO ENABLE/DISABLE THE INTELLIGENT DRIVER ALERTNESS SYSTEM WARNING



- ① Steering-wheel-mounted control (left side)
 ② Vehicle information display

Perform the following steps to enable or disable the Intelligent Driver Alertness system warning.

1. Push the ◀ ▶ button until [Settings] appears in the vehicle information display

2. Select [Driver Assistance] and push the scroll dial.
 and push the scroll dial. Use the scroll dial to select [Driver Assistance]. Then push the scroll dial.

NOTE:

- The Intelligent Driver Alertness system will automatically be turned on when the e-POWER system is restarted.
- As long as Steering Assist (where fitted) is activated, the Intelligent Driver Alertness system will be deactivated.

Turning off Steering Assist reactivates the Intelligent Driver Alertness system.

INTELLIGENT DRIVER ALERTNESS SYSTEM LIMITATIONS

WARNING

Listed below are the system limitations for the Intelligent Driver Alertness system. Failure to operate the vehicle in accordance with these system limitations could result in serious injury or death.

- The Intelligent Driver Alertness system may not operate properly and may not provide an alert in the following conditions:
 - Poor road conditions such as an uneven road surface or pot holes.
 - Strong side wind.
 - If you have adopted a sporty driving style with higher cornering speeds or higher rates of acceleration.
 - Frequent lane changes or changes to vehicle speed.
- The Intelligent Driver Alertness system will not provide an alert in the following conditions:

REAR AUTOMATIC BRAKING (RAB) (where fitted)

- Vehicle speeds lower than 60 km/h (37 MPH).
- Short lapses of attention.
- Instantaneous distractions such as dropping an object.
- While Steering Assist (where fitted) is activated.

SYSTEM MALFUNCTION

If the Intelligent Driver Alertness system malfunctions, it will be turned off automatically, the Intelligent Driver Alertness indicator light (yellow) will illuminate and the [System fault See Owner's Manual] warning message will appear in the vehicle information display.

Action to take

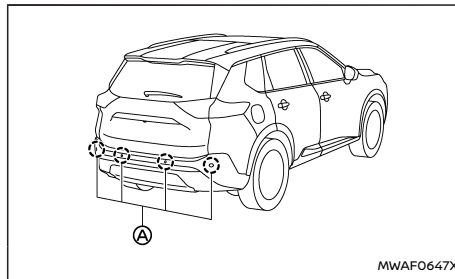
If the indicator light (yellow) illuminates, pull off the road to a safe location and stop the vehicle. Turn the e-POWER system off and restart the e-POWER system. If the indicator light (yellow) continues to illuminate, have the system checked. It is recommended that you visit a NISSAN dealer or qualified workshop for this service.

WARNING

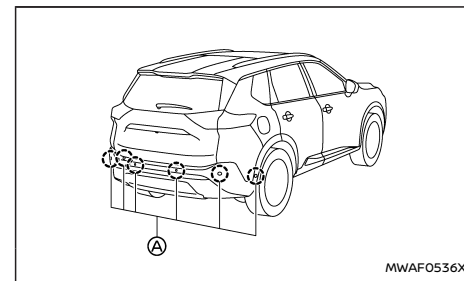
Failure to follow the warnings and instructions for proper use of the RAB system could result in serious injury or death.

- The RAB system is a supplemental aid to the driver. It is not a replacement for proper driving procedures. Always use the side and rear mirrors and turn and look in the direction you will move before and while reversing. Never rely solely on the RAB system. It is the driver's responsibility to stay alert, drive safely, and be in control of the vehicle at all times.
- There is a limitation to the RAB system capability. The RAB system is not effective in all situations.


The RAB system can assist the driver when the vehicle is reversing and approaching objects directly behind the vehicle.



Models with 4 sensors

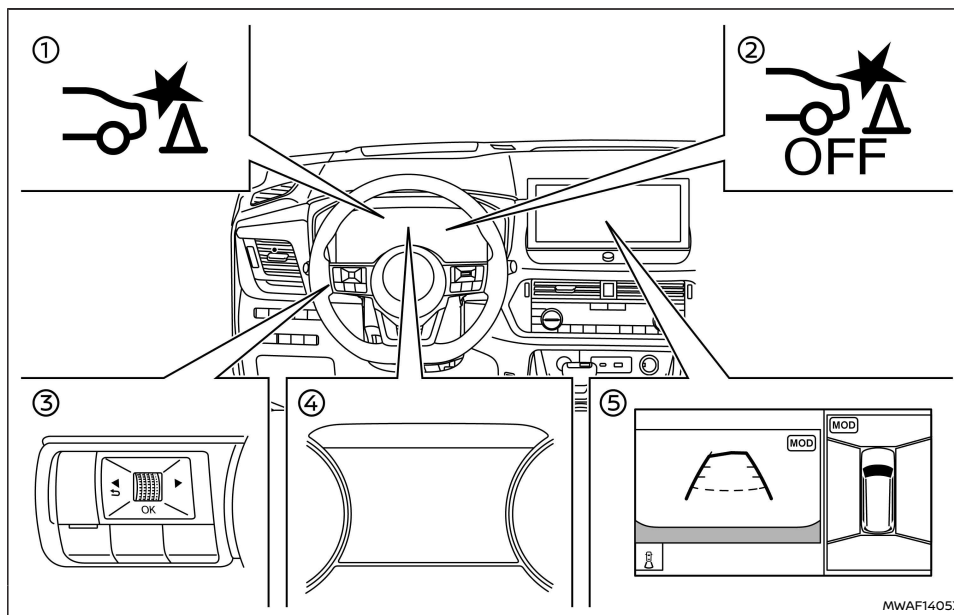


Models with 6 sensors

The RAB system detects obstacles behind the vehicle using the parking sensors  located on the rear bumper.

NOTE:

You can temporarily cancel the sensor function and the RAB system in the vehicle. For additional information, see "Parking sensor (sonar) system" (P.377).



Example

- ① RAB system warning indicator (on the vehicle information display)
- ② RAB system OFF warning light (on the meter panel)
- ③ Steering-wheel-mounted controls (left side)
- ④ Vehicle information display
- ⑤ Centre display (where fitted)

RAB SYSTEM OPERATION

When the shift lever is in the R (Reverse) position and the vehicle speed is between approximately 3 km/h (2 MPH) and 15 km/h (9 MPH), the RAB system operates.

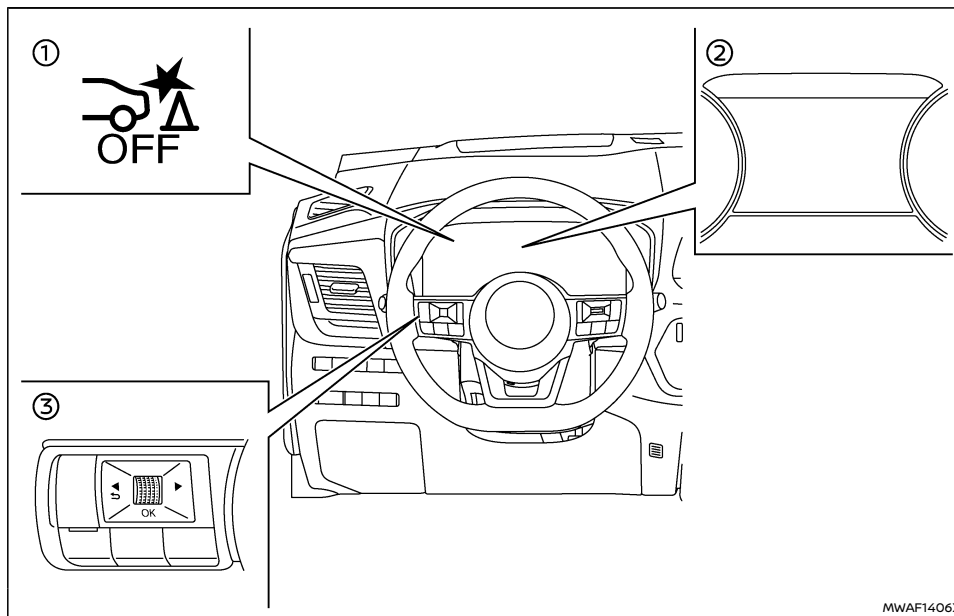
If a risk of a collision with an obstacle is detected when your vehicle is reversing, the RAB system warning indicator will flash in the vehicle informa-

tion display, a red frame will appear in the centre display (models with the Intelligent Around View Monitor system), and the system will chime three times. The system will then automatically apply the brakes. After the automatic brake application, the driver must depress the brake pedal to maintain brake pressure.

NOTE:

- The brake lights of the vehicle come on when braking is performed by the RAB system.
- When the brakes operate, a noise may be heard. This is not a malfunction.

TURNING THE RAB SYSTEM ON/OFF



- ① RAB system OFF warning light
- ② Vehicle information display
- ③ Steering-wheel-mounted control (left side)

Perform the following steps to turn the RAB system ON or OFF.

1. Push the ◀ ▶ button until [Settings] appears in the vehicle information display and then push the scroll dial. Use the scroll dial to select [Driver Assistance]. Then push the scroll dial.

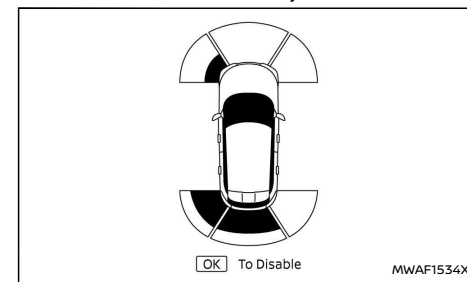
2. Select [Emergency Brake] and push the scroll dial.
3. Select [Rear] and use the scroll dial to turn the system on or off.

When the RAB system is turned off, the RAB system OFF warning light illuminates when the shift lever is in the R (Reverse) position.

The RAB system OFF warning light will also illuminate when the shift lever is in the R (Reverse) position and the RAB system is ON if the parking sensors (sonar) have been temporarily disabled using the [Parking Aids] setting.

NOTE:

- The RAB system will be automatically turned on when the e-POWER system is restarted.

**Example**

- When the shift lever is in the R (Reverse) position and the Parking Aids screen is displayed in the vehicle information display, the parking sensor (sonar) system can be

disabled temporarily by pushing the scroll dial on the steering wheel.

RAB SYSTEM LIMITATIONS

WARNING

Listed below are the system limitations for the RAB system. Failure to follow the warnings and instructions for proper use of the RAB system could result in serious injury or death.

- When the vehicle approaches an obstacle while the accelerator or brake pedal is depressed, the function may not operate or the start of the operation may be delayed. The RAB system may not operate or may not perform sufficiently due to vehicle conditions, driving conditions, the traffic environment, the weather, road surface conditions, etc. Do not wait for the system to operate. Operate the brake pedal by yourself as soon as necessary.
- If it is necessary to override RAB operation, strongly press the accelerator pedal.
- Always check your surroundings and turn to check what is behind you before and while reversing. The RAB system detects stationary objects behind the vehicle. The RAB system does not detect the following objects:
 - Moving objects
 - Low objects
 - Narrow objects
 - Wedge-shaped objects

- Complex-shaped objects
- Multiple object in close
- Objects close to the bumper (less than approximately 1 ft (30 cm))
- Objects that suddenly appear
- Thin objects such as rope, wire, chain, etc.
- The RAB system may not operate for pedestrians or animals.
- The RAB system may not operate for the following obstacles:
 - Obstacles located high off the ground
 - Obstacles in a position offset from your vehicle
 - Obstacles, such as spongy materials or snow, that have soft outer surfaces and can easily absorb a sound wave
- The RAB system may not operate in the following conditions:
 - There is rain, snow, ice, dirt, etc., attached to the parking sensors.
 - A loud sound is heard in the area around the vehicle.
 - The surface of the obstacle is diagonal to the rear of the vehicle.
 - The parking sensors or the area around them are extremely hot or cold.
- The RAB system may unintentionally operate in the following conditions:

- There is overgrown grass in the area around the vehicle.
- There is a structure (e.g., a wall, toll gate equipment, a narrow tunnel, a parking lot gate) near the side of the vehicle.
- There are bumps, protrusions, or man-hole covers on the road surface.
- The vehicle is driving through a draped flag or a curtain.
- The vehicle is driving on a steep hill.
- There is an accumulation of snow or ice behind the vehicle.
- An ultrasonic wave source, such as another vehicle's parking sensor, is near the vehicle.
- Once the automatic brake control operates, it does not operate again if the vehicle approaches the same obstacle.
- The automatic brake control can only operate for a short period of time. Therefore, the driver must depress the brake pedal.
- In the following situations, the RAB system may not operate properly or may not function sufficiently:
 - The vehicle is driven in bad weather (rain, fog, snow, etc.).
 - The vehicle is driven on a steep hill.
 - The vehicle's posture is changed (e.g., when driving over a bump).

- The vehicle is driven on a slippery road.
 - The vehicle is turned sharply by turning the steering wheel fully.
 - Snow chains are used.
 - Wheels or tyres other than NISSAN recommended are used.
 - The brakes are cold at low ambient temperatures or immediately after driving has started.
 - The braking force becomes poor due to wet brakes after driving through a puddle or washing the vehicle.
- Turn the RAB system off in the following conditions to prevent the occurrence of an unexpected accident resulting from sudden system operation:
 - The vehicle is towed.
 - The vehicle is carried on a flatbed truck.
 - The vehicle is on the chassis dynamometer.
 - The vehicle drives on an uneven road surface.
 - Suspension parts other than those designated as genuine parts are used. (If the vehicle height or the vehicle body inclination is changed, the system may not detect an obstacle correctly.)
 - When towing a trailer or other vehicle, turn the RAB system off to prevent the occur-

rence of an unexpected accident resulting from sudden system operation. (See "RAB system operation" (P.359).)

- Excessive noise (e.g., audio system volume, an open vehicle window) will interfere with the chime sound, and it may not be heard.

SYSTEM MALFUNCTION

If the RAB system malfunctions, it will be turned off automatically, a chime will sound, the RAB system OFF warning light will illuminate, and the [System fault See Owner's Manual] warning message will appear in the vehicle information display.

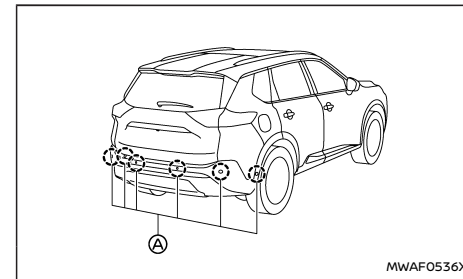
Action to take

If the warning light illuminates, park the vehicle in a safe location, turn the e-POWER system off, and restart the e-POWER system. If the warning light continues to illuminate, have the RAB system checked. It is recommended that you visit a NISSAN dealer or qualified workshop for this service.

NOTE:

If the RAB system cannot be operated temporarily, the RAB system OFF warning light blinks.

SYSTEM MAINTENANCE



Example

The parking sensors (A) (4 or 6) are located on the rear bumper. Observe the following items to ensure proper operation of the system:

- Always keep the sensors clean.
- If the sensors are dirty, wipe them off with a soft cloth while being careful to not damage them.
- The sensors may be blocked by temporary ambient conditions such as splashing water, mist or fog. The blocked condition may also be caused by objects such as ice, frost or dirt obstructing the sensors. Check for and remove objects obstructing the area around the sensors.
- Do not subject the area around the sensors to strong impact. Also, do not remove or disassemble the sensors. If the sensors and peripheral areas are deformed in an accident, etc., have the sensors checked. It is recommended

FUEL EFFICIENT DRIVING TIPS

that you visit a NISSAN dealer or qualified workshop for this service.

- Do not attach stickers (including transparent material), install accessories or apply additional paint on the sensors and their surrounding areas. This may cause a malfunction or improper operation.
- When washing the vehicle using a high-pressure washer, do not apply direct washer pressure on the sensors. This may cause a malfunction of the sensors.

Follow these easy-to-use Fuel Efficient Driving Tips to help you achieve the most fuel economy from your vehicle.

1. Use smooth accelerator and brake pedal application.
 - Avoid rapid starts and stops.
 - Use smooth, gentle accelerator and brake application whenever possible.
 - Maintain constant speed while commuting and coast whenever possible.
2. Maintain constant speed.
 - Look ahead to try and anticipate and minimise stops.
 - Synchronizing your speed with traffic lights allows you to reduce your number of stops.
 - Maintaining a steady speed can minimise red light stops and improve fuel efficiency.
3. Close windows when driving.
 - Driving with a window open at 100 km/h (60 MPH) increases fuel consumption by up to 4%. Driving with the windows closed allows for better fuel economy.
4. Optimize the use of air conditioning.
 - The air conditioning system has a positive effect on driving and vehicle safety through comfort cooling and dehumidifying, drivers are more alert and have better visibility when window demisting / defogging becomes necessary. However, use of the air conditioning system will increase fuel consumption substantially in an urban environment. Optimize the use of air conditioning by using the vent as much as possible.
5. Drive at economical speeds and distances.
 - Observing the speed limit and not exceeding 97 km/h (60 MPH) (where legally allowed) can improve fuel efficiency due to reduced aerodynamic drag.
 - Maintaining a safe following distance behind other vehicles reduces unnecessary braking.
 - Safely monitoring traffic to anticipate changes in speed permits reduced braking and smooth acceleration changes.
6. Use cruise control.
 - Using cruise control during highway driving helps maintain a steady speed.
 - Cruise control is particularly effective in providing fuel savings when driving on flat terrains.
7. Plan for the shortest route.
 - Utilise a map or navigation system (where fitted) to determine the best route to save time.
8. Buy an automated pass for toll roads.
 - Automated passes permit drivers to use special lanes to maintain cruising speed through the toll and avoid stopping and starting.
9. Winter warm up.
 - Limit idling time to minimise impact to fuel economy.

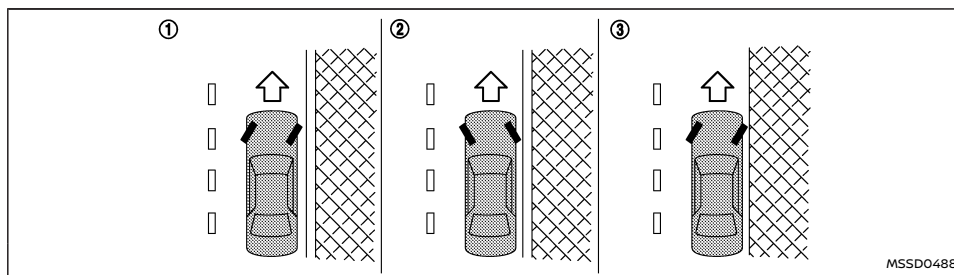
INCREASING FUEL ECONOMY AND REDUCING CARBON DIOXIDE EMISSIONS

- Vehicles typically need no more than 30 seconds of idling at start-up to effectively circulate the engine oil before driving.
 - Your vehicle will reach its ideal operating temperature more quickly while driving versus idling.
10. Keeping your vehicle cool.
- Park your vehicle in a covered parking area or in the shade whenever possible.
 - When entering a hot vehicle, opening the windows will help to reduce the inside temperature faster, resulting in reduced demand on your A/C system.
- Keep your engine tuned up.
 - Follow the recommended scheduled maintenance.
 - Keep the tyres inflated to the correct pressure. Low tyre pressure increases tyre wear and lowers fuel economy.
 - Keep the wheels in correct alignment. Improper alignment increases tyre wear and lowers fuel economy.
 - Use the recommended viscosity engine oil. (See "Recommended fluids/lubricants and capacities" (P.456).)

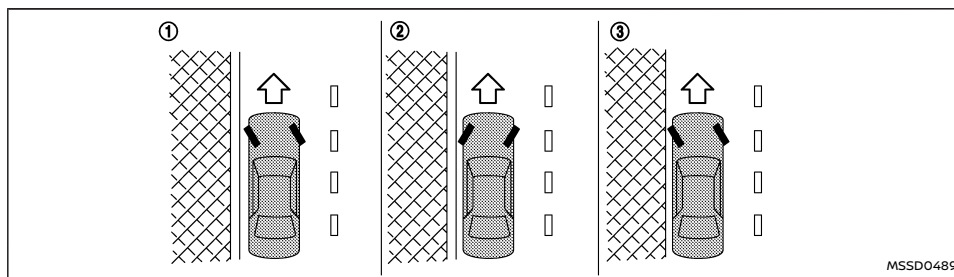
PARKING

WARNING

- **Do not stop or park the vehicle over flammable materials such as dry grass, waste paper or rags. They may ignite and cause a fire.**
- **Never leave the e-POWER system running while the vehicle is unattended.**
- **Do not leave children unattended inside the vehicle. They could unknowingly activate switches or controls. Unattended children could become involved in serious accidents.**
- **To help avoid risk of injury or death through unintended operation of the vehicle and/or its systems, do not leave children, people who require the assistance of others or pets unattended in your vehicle. Additionally, the temperature inside a closed vehicle on a warm day can quickly become high enough to cause a significant risk of injury or death to people and pets.**
- **Safe parking procedures require that both the parking brake be applied and the transmission placed into P (Park). Failure to do so could cause the vehicle to move unexpectedly or roll away and result in an accident.**
- **When parking the vehicle, make sure the vehicle is placed in the P (Park) position. The shift position cannot be moved out of the P (Park) position without depressing the footbrake pedal.**



Left-Hand Drive (LHD) model



Right-Hand Drive (RHD) model

1. Apply the parking brake.
2. Push the P position switch to shift to the P (Park) position.
3. To help prevent the vehicle from rolling into the street when parked on a sloping drive way, it is a good practice to turn the wheels as illustrated.

- HEADED DOWNHILL WITH KERB: ①
Turn the wheels into the kerb and move the vehicle forward until the kerb side wheel gently touches the kerb.
- HEADED UPHILL WITH KERB: ②
Turn the wheels away from the kerb and move the vehicle back until the kerb side wheel gently touches the kerb.

- HEADED UPHILL OR DOWNHILL, NO KERB: ③
Turn the wheels toward the side of the road so the vehicle will move away from the centre of the road if it moves.
4. Place the power switch in the OFF position.

TRAILER TOWING

Your new vehicle was designed to be used primarily to carry passengers and luggage.

Towing a trailer will place additional loads on your vehicle's engine, drive train, steering, braking and other systems. The towing of a trailer will exaggerate other conditions such as sway caused by crosswinds, rough road surfaces or passing trucks.

Your driving style and speed must be adjusted according to the circumstances. Before towing a trailer, see a NISSAN dealer or qualified workshop for an explanation about the proper use of towing equipment.

OPERATING PRECAUTIONS

- Avoid towing a trailer during the running-in period.
- Before driving, make sure that the lighting system of the trailer works properly.
- Observe the legal maximum speeds for trailer operation.
Do not exceed 100 km/h (62 MPH).
- Avoid abrupt starts, accelerations and stops.
- Avoid sharp turns and lane changes.
- Always drive your vehicle at a moderate speed.
- Do not use the following systems (where fitted) while towing a trailer:
 - Emergency Lane Assist (ELA) system
 - Blind Spot Warning (BSW) system
 - Intelligent Blind Spot Intervention system
 - Rear Cross Traffic Alert (RCTA) system
 - Intelligent Cruise Control (ICC) system

- ProPILOT Assist system
- e-Pedal Step system
- Intelligent Emergency Braking with Pedestrian Detection system
- Intelligent Forward Collision Warning system
- Rear Automatic Braking (RAB) system

- Follow the trailer manufacturer's instructions.
- Choose proper coupling devices (trailer hitch, safety chain, roof carrier, etc.) for your vehicle and trailer. These devices are available from a NISSAN dealer or qualified workshop where you can also obtain more detailed information about trailer towing.
- Never allow the total trailer load (trailer weight plus its cargo weight) to exceed the maximum set for the vehicle and the coupling device. See a NISSAN dealer or qualified workshop for more information.
- The trailer must be loaded so that heavy goods are placed over the axle. The maximum allowable vertical load on the trailer hitch must not be exceeded.
- Have your vehicle serviced more often than at the intervals specified in a separate maintenance booklet.
- Trailer towing requires more energy than under normal circumstances because of a considerable increase in traction power and resistance.
- For models with motion-activated power back door, be sure to deactivate the power back door operation when using the tow bar (where fitted) to avoid unintentional operation. (See

"Operating power back door (where fitted)" (P.174).)

TYRE PRESSURE

When towing a trailer, inflate the vehicle tyres to the maximum recommended COLD tyre pressure (for full loading) indicated on the tyre placard.

SAFETY CHAINS

Always use a suitable chain between the vehicle and trailer. The chain should be crossed and should be attached to the hitch, not to the vehicle bumper or axle. Be sure to leave enough slack in the chain to permit turning corners.

TRAILER BRAKES

Ensure that trailer brakes are installed as required by local regulations. Also check that all other trailer equipment conforms to local regulations.

Always block the wheels on both the vehicle and trailer when parking. Apply the hand brake on the trailer where fitted. Parking on a steep slope is not recommended.

If parking on a steep slope is unavoidable, push the P position switch to shift to the P (Park) position, and turn the front wheels towards the kerb.

TRAILER DETECTION (where fitted)

When towing a trailer with a genuine NISSAN tow bar electrical kit and the turn signal switch is used, the electrical system of the vehicle will detect the additional electrical load of the trailer lighting. As a result, the direction indicator tone will be different.

TRAILER SWAY CONTROL

To minimise trailer sway, your vehicle may apply braking to individual wheels based on input from your vehicle sensors and vehicle speed. Trailer Sway Control is a function of the Electronic Stability Programme (ESP) system and is active when the ESP function is enabled.

CAUTION

If the ESP system is turned OFF, the Trailer Sway Control is also disabled.

When Trailer Sway Control is in operation, the slip indicator light blinks. When vehicle control is regained, slip indicator light will turn OFF.

For additional information about the ESP system, see "Electronic Stability Programme (ESP) system" (P.372).

If Trailer Sway Control activates

1. Take your foot off the accelerator pedal to allow the vehicle to coast and steer as straight ahead as the road conditions allow. This combination will help stabilise the vehicle.

CAUTION

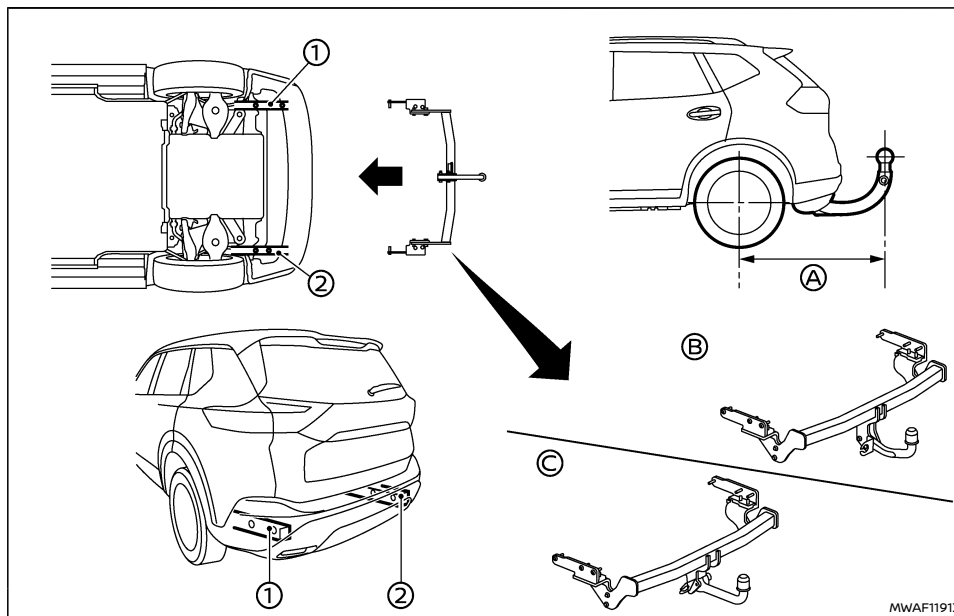
Do not try to correct trailer sway by steering or applying the brakes.

2. When the trailer sway stops, gently apply the brakes and pull to the side of the road in a safe area.
3. Try to rearrange the trailer load so it is balanced.

NOTE:

Trailer Sway Control cannot reduce trailer sway in all situations.

COUPLING DEVICE INSTALLATION (for Europe)



© Detachable tow bar

Follow all of the coupling device manufacturer's instructions for installation and use.

NISSAN recommends that the coupling device for trailer towing be installed under the following conditions:

- Maximum permissible vertical load on the coupling device: 981 N (100 kg, 221 lb)
- The coupling device, mounting points and installation parts on your vehicle: as shown as an example in the illustration.
- Rear overhang of coupling device:
 - (A) 1,120 mm (44.1 in)
 - (B) Fixed tow bar
 - (C) Detachable tow bar


ELECTRIC POWER STEERING

WARNING

- **If the e-POWER system is not running or is turned off while driving, the power assist for the steering will not work. Steering will be harder to operate.**
- **When the electric power steering warning light illuminates with the e-POWER system running, the power assist for the steering will be limited or cease operation. You will still have control of the vehicle but the steering will be harder to operate.**

The electric power steering is designed to provide power assist while driving to operate the steering wheel with light force.

When SPORT mode is selected, the steering wheel effort is moderately increased for a sporty feel. (See "SPORT mode" (P.240).)

When the steering wheel is operated repeatedly or continuously while parking or driving at a very low speed, the power assist for the steering wheel will be reduced. This is to prevent overheating of the electric power steering and protect it from getting damaged. While the power assist is reduced, steering wheel operation will become heavy. If the steering wheel operation is still performed, the electric power steering may stop and the electric power steering warning light  will illuminate. In a safe location, stop the e-POWER system and place the power switch in the OFF position. When the temperature of the electric power steering goes down, the power assist level will return to normal. Avoid repeating such steering wheel

operations that could cause the electric power steering to overheat.

You may hear a noise when the steering wheel is operated quickly. However, this is not a malfunction.

If the electric power steering warning light illuminates while the e-POWER system is running, it may indicate the electric power steering is not functioning properly and may need servicing. Have the electric power steering checked. It is recommended that you visit a NISSAN dealer or qualified workshop for this service. (See "Electric power steering warning light" (P.86).)

When the electric power steering warning light illuminates with the e-POWER system running, the power assist for the steering will be limited or cease operation, which may cause the steering wheel operation to become heavy. Even if this occurs, the performance of the manual steering is ensured. Grip the steering wheel securely and operate it with greater force than usual.

BRAKE SYSTEM

BRAKING PRECAUTIONS

This vehicle is equipped with two braking systems:

1. Hydraulic brake system
2. Regenerative brake system

Hydraulic brake system

The hydraulic brake system is similar to the brakes used on conventional vehicles.

The brake system has two separate hydraulic circuits. If one circuit malfunctions, you will still have braking at two wheels.

Regenerative brake system

The primary purpose of regenerative brake system is to provide some power to help recharge the Li-ion battery and extend driving range. A secondary benefit is "engine braking" that operates based on battery conditions.

In the D (Drive) position, when the accelerator is released, the regenerative brake system provides some deceleration and generates power for the Li-ion battery. Power is also generated when the brake pedal is applied.

When you put the shift lever in the B position and take your foot off the accelerator pedal, more regenerative brake is applied than in the D (Drive) position. However, during high-speed driving you may feel that regenerative brake provides less deceleration than the engine braking in an ordinary vehicle. This is normal.

Less deceleration is provided by the regenerative brake system when the Li-ion battery is fully charged. Regenerative brake is automatically re-

duced when the Li-ion battery is fully charged to prevent the Li-ion battery from becoming overcharged. Regenerative brake is also automatically reduced when the battery temperature is high/low to prevent Li-ion battery damage.

The brake pedal should be used to slow or stop the vehicle depending on traffic or road conditions. The vehicle brakes are not affected by regenerative brake system operation.

NOTE:

- When applying the regenerative brakes, you may hear a sound coming from the regenerative brake system. This is a normal operating characteristic of an EV (Electric Vehicle).
- If the power switch position is in a position other than ON or READY to drive, you can stop the vehicle by depressing the brake pedal. However, greater foot pressure on the brake pedal will be required to stop the vehicle, and the stopping distance will be longer.
- When depressing the brake pedal, the braking pedal feel will not be smooth or may change when the cooperative regenerative brake system activates. However, the electronically controlled brake system is operating normally and this does not indicate a malfunction.

Using the brakes

Avoid resting your foot on the brake pedal while driving. This will cause overheating of the brakes, wearing out the brake pads faster and will reduce driving range.

To help reduce brake wear and to prevent the brakes from overheating, reduce speed and select the B position before going down a slope or long grade. Overheated brakes may reduce braking performance and could result in loss of vehicle control.

WARNING

- While driving on a slippery surface, be careful when braking or accelerating. Abrupt braking or accelerating could cause the wheels to skid, which could result in an accident.
- If the brake pedal is depressed with the e-POWER system OFF, you may feel an increased brake pedal effort and a decreased pedal stroke. If the brake warning light (red) does not illuminate and the brake pedal feels like it has returned to its normal state after the e-POWER system is started, this indicates that there is no malfunction and the vehicle can be operated normally.

Wet brakes

When the vehicle is washed or driven through water, the brakes may get wet. As a result, your braking distance will be longer and the vehicle may pull to one side during braking.

To dry brakes, drive the vehicle at a safe speed while lightly tapping the brake pedal to heat-up the brakes. Do this until the brakes return to normal. Avoid driving the vehicle at high speeds until the brakes function correctly.

BRAKE ASSIST

When the force applied to the brake pedal exceeds a certain level, the Brake Assist is activated generating greater braking force than a conventional brake booster even with light pedal force.

WARNING

The Brake Assist is only an aid to assist braking operation and is not a collision warning or avoidance device. It is the driver's responsibility to stay alert, drive safely and be in control of the vehicle at all times.

ANTI-LOCK BRAKING SYSTEM (ABS)

WARNING

- The Anti-lock Braking System (ABS) is a sophisticated device, but it cannot prevent accidents resulting from careless or dangerous driving techniques. It can help maintain vehicle control during braking on slippery surfaces. Remember that stopping distances on slippery surfaces will be longer than on normal surfaces even with ABS. Stopping distances may also be longer on rough, gravel or snow covered roads, or if you are using tyre chains. Always maintain a safe distance from the vehicle

in front of you. Ultimately, the driver is responsible for safety.

- **Tyre type and condition may also affect braking effectiveness.**
 - **When replacing tyres, install the specified size of tyres on all four wheels.**
 - **For detailed information, see “Tyres and Wheels” (P.447).**

The Anti-lock Braking System (ABS) controls the brakes so the wheels do not lock during hard braking or when braking on slippery surfaces. The system detects the rotation speed at each wheel and varies the brake fluid pressure to prevent each wheel from locking and sliding. By preventing each wheel from locking, the system helps the driver maintain steering control and helps to minimise swerving and spinning on slippery surfaces.

Using the system

Depress the brake pedal and hold it down. Depress the brake pedal with firm steady pressure, but do not pump the brakes. The ABS will operate to prevent the wheels from locking up. Steer the vehicle to avoid obstacles.

WARNING

Do not pump the brake pedal. Doing so may result in increased stopping distances.

Self-test feature

The ABS includes electronic sensors, electric pumps, hydraulic solenoids and a computer. The computer has a built-in diagnostic feature that tests the system each time you place the power switch in the READY to drive position and move the vehicle at a low speed in forward or reverse. When the self-test occurs, you may hear a “clunk” noise and/or feel a pulsation in the brake pedal. This is normal and does not indicate a malfunction. If the computer senses a malfunction, it switches the ABS off and illuminates the ABS warning light on the instrument panel. The brake system then operates normally, but without anti-lock assistance.

If the ABS warning light illuminates during the self-test or while driving, have the vehicle checked. It is recommended you visit a NISSAN dealer or qualified workshop for this service.

Normal operation

The ABS operates at speeds above 5 to 10 km/h (3 to 6 MPH). The speed varies according to road conditions.

When the ABS senses that one or more wheels are close to locking up, the actuator rapidly applies and releases hydraulic pressure. This action is similar to pumping the brakes very quickly. You may feel a pulsation in the brake pedal and hear a noise from under the bonnet or feel a vibration from the actuator when it is operating. This is normal and indicates that the ABS is operating properly. However, the pulsation may indicate that


road conditions are hazardous and extra care is required while driving.

ELECTRONIC STABILITY PROGRAMME (ESP) SYSTEM

The Electronic Stability Programme (ESP) system uses various sensors to monitor driver inputs and vehicle motion. Under certain driving conditions, the ESP system helps to perform the following functions.


- Controls brake pressure to reduce wheel slip on one slipping drive wheel so power is transferred to a non slipping drive wheel on the same axle.
- Controls brake pressure and traction motor output to reduce drive wheel slip based on vehicle speed (traction control function).
- Controls brake pressure at individual wheels and traction motor output to help the driver maintain control of the vehicle in the following conditions:
 - understeer (vehicle tends to not follow the steered path despite increased steering input)
 - oversteer (vehicle tends to spin due to certain road or driving conditions).




The ESP system can help the driver to maintain control of the vehicle, but it cannot prevent loss of vehicle control in all driving situations.

When the ESP system operates, the slip indicator light  in the instrument panel flashes so note the following:

- The road may be slippery or the system may determine some action is required to help keep the vehicle on the steered path.
- You may feel a pulsation in the brake pedal and hear a noise or vibration from under the bonnet. This is normal and indicates that the ESP system is working properly.

- Adjust your speed and driving to the road conditions.

If a malfunction occurs in the system, the slip indicator light  illuminates in the instrument panel. The ESP system automatically turns off.

The vehicle information display is used to turn off the ESP system. The ESP off indicator  illuminates to indicate the ESP system is off. When the ESP system is turned off, the ESP system still operates to prevent one drive wheel from slipping by transferring power to a non slipping drive wheel. The slip indicator light  flashes if this occurs. All other ESP functions are off, and the slip indicator light  will not flash. The ESP system is automatically reset to on when the power switch is placed in the off position then back to the on position.






See “Slip indicator light” (P.90) and “Electronic Stability Programme (ESP) off indicator light” (P.91).

The computer has a built-in diagnostic feature that tests the system each time you start the e-POWER system and move the vehicle forward or in reverse at a slow speed. When the self-test occurs, you may hear a “clunk” noise and/or feel a pulsation in the brake pedal. This is normal and is not an indication of a malfunction.

WARNING

- **The ESP system is designed to help improve driving stability but does not prevent accidents due to abrupt steering operation at high speeds or by careless or dangerous driving techniques. Reduce vehicle speed and be especially careful**

when driving and cornering on slippery surfaces and always drive carefully.

- **Do not modify the vehicle’s suspension. If suspension parts such as shock absorbers, struts, springs, stabiliser bars, bushings and wheels are not NISSAN recommended for your vehicle or are extremely deteriorated, the ESP system may not operate properly. This could adversely affect vehicle handling performance, and the slip indicator light  may illuminate.**
- **If brake related parts such as brake pads, rotors and callipers are not NISSAN recommended or are extremely deteriorated, the ESP system may not operate properly and the slip indicator light  may illuminate.**
- **If traction motor control related parts are not NISSAN recommended or are extremely deteriorated, the slip indicator light  may illuminate.**
- **When driving on extremely inclined surfaces such as higher banked corners, the ESP system may not operate properly and the slip indicator light  may illuminate. Do not drive on these types of roads.**
- **When driving on an unstable surface such as a turntable, ferry, elevator or ramp, the slip indicator light  may illuminate. This is not a malfunction. Restart the e-POWER system after driving onto a stable surface.**
- **If wheels or tyres other than the NISSAN recommended ones are used, the ESP**

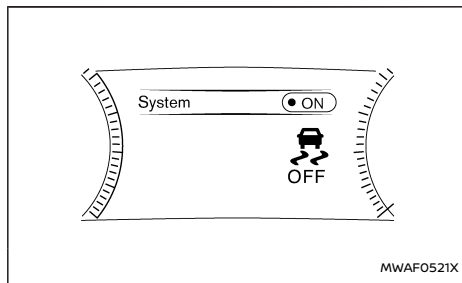
system may not operate properly and the slip indicator light  may illuminate.

- **The ESP system is not a substitute for winter tyres or tyre chains on a snow covered road.**

HOW TO TURN OFF THE ESP SYSTEM


The vehicle should be driven with the Electronic Stability Programme (ESP) system ON for most driving conditions.

When the vehicle is stuck in mud or snow, the ESP system reduces the traction motor output to reduce wheel spin. The vehicle speed will be reduced even if the accelerator is depressed to the floor. If maximum traction motor power is needed to free a stuck vehicle, turn the ESP system off.



Example

To turn off the ESP system, perform the following steps in the vehicle information display.


1. Push the ◀ ▶ button on the steering wheel until [Settings] appears and then push the scroll dial.
2. Use the scroll dial to select [ESP Setting] and then push it.
3. Select [System] and push the scroll dial. The  indicator light will illuminate.



Turn the ESP system back on in the vehicle information display or restart the e-POWER system to turn on the ESP system.














BRAKE FORCE DISTRIBUTION

During braking while driving through turns, the system optimizes the distribution of force to each of the four wheels depending on the radius of the turn.

WARNING

- **The ESP system is designed to help the driver maintain stability but does not prevent accidents due to abrupt steering operation at high speeds or by careless or dangerous driving techniques. Reduce vehicle speed and be especially careful when driving and cornering on slippery surfaces and always drive carefully.**
- **Do not modify the vehicle's suspension. If suspension parts such as shock absorbers, struts, springs, stabiliser bars, bushings and wheels are not NISSAN recommended for your vehicle or are extremely deteriorated, the ESP system may not operate properly. This could adversely affect vehicle handling performance, and the .**

indicator light may flash or both the  and  indicator lights may illuminate.

- **If brake related parts such as brake pads, rotors and callipers are not NISSAN recommended or are extremely deteriorated, the ESP system may not operate properly and both the  and  indicator lights may illuminate.**
- **If traction motor control related parts are not NISSAN recommended or are extremely deteriorated, both the  and  indicator lights may illuminate.**
- **When driving on extremely inclined surfaces such as higher banked corners, the ESP system may not operate properly and the  indicator light may flash or both the  and  indicator lights may illuminate. Do not drive on these types of roads.**
- **When driving on an unstable surface such as a turntable, ferry, elevator or ramp, the  indicator light may flash or both the  and  indicator lights may illuminate. This is not a malfunction. Restart the e-POWER system after driving onto a stable surface.**
- **If wheels or tyres other than the NISSAN recommended ones are used, the ESP system may not operate properly and the  indicator light may flash or both the  and  indicator lights may illuminate.**
- **The ESP system is not a substitute for**

CHASSIS CONTROL

winter tyres or tyre chains on a snow covered road.

The chassis control is an electric control module that includes the following function:

- Intelligent Trace Control

INTELLIGENT TRACE CONTROL

This system senses driving based on the driver's steering and acceleration/braking patterns, and controls brake pressure at individual wheels, driving torque control* and driving torque distribution control* to aid tracing at corners and help smooth vehicle response.

The Intelligent Trace Control can be set to ON (enabled) or OFF (disabled) using the [Driver Assistance] settings in the vehicle information display. (See "Settings" (P.93). Driving torque distribution control* is not turned off.)

When the ESP system is turned off, the Intelligent Trace Control is also turned off. (Even if the ESP is turned off to escape muddy or snowy roads, driving torque distribution control* will not be turned off to ensure traction.)

(*: Only equipped for 4WD)

Amount of the Intelligent Trace Control is changed depending on the mode selected by the Drive Mode Selector.

When the Intelligent Trace Control is not functioning properly, the master warning light illuminates, and the warning message [Chassis control system fault] will also appear in the vehicle information display.

If the chassis control warning message appears in the vehicle information display, it may indicate that the Intelligent Trace Control is not functioning

properly. Have the system checked as soon as possible. It is recommended that you visit a NISSAN dealer or qualified workshop for this service. (See "Vehicle information display warnings and indicators" (P.101).)

WARNING

The Intelligent Trace Control may not be effective depending on the driving condition. Always drive carefully and attentively.

When the Intelligent Trace Control is operating, you may feel a pulsation in the brake pedal and hear a noise. This is normal and indicates that the Intelligent Trace Control is operating properly. You may also feel deceleration when the Intelligent Trace Control is operating. However, this is not a malfunction.

HILL START ASSIST SYSTEM

WARNING

- **Never rely solely on the hill start assist system to prevent the vehicle from moving backward on a hill. Always drive carefully and attentively. Depress the brake pedal when the vehicle is stopped on a steep hill. Be especially careful when stopped on a hill on frozen or muddy roads. Failure to prevent the vehicle from rolling backwards may result in a loss of control of the vehicle and possible serious injury or death.**
- **The hill start assist system is not designed to hold the vehicle at a standstill on a hill. Depress the brake pedal when the vehicle is stopped on a steep hill. Failure to do so may cause the vehicle to roll backwards and may result in a collision or serious personal injury.**
- **The hill start assist system may not prevent the vehicle from rolling backwards on a hill under all load or road conditions. Always be prepared to depress the brake pedal to prevent the vehicle from rolling backwards. Failure to do so may result in a collision or serious personal injury.**

The hill start assist system automatically keeps the brakes applied to help prevent the vehicle from rolling backwards in the time it takes the driver to release the brake pedal and apply the accelerator when the vehicle is stopped on a hill.

The hill start assist system will operate automatically under the following conditions:

- The transmission is shifted to a forward or reverse gear.
- The vehicle is stopped completely on a hill by applying the brake.

The maximum holding time is 2 seconds. After 2 seconds the vehicle will begin to roll back and the hill start assist system will stop operating completely.

The hill start assist system will not operate when the transmission is shifted to the N (Neutral) or P (Park) position or on a flat and level road.

When the slip indicator light illuminates in the meter, the hill start assist system will not operate. (See "Slip indicator light" (P.90).)

HILL DESCENT CONTROL SYSTEM (where fitted)

WARNING

- **Never rely solely on the hill descent control system to control vehicle speed when driving on steep downhill grades. Always drive carefully when using the hill descent control system and decelerate the vehicle speed by depressing the brake pedal if necessary. Be especially careful when driving on frozen, muddy or extremely steep downhill roads. Failure to control vehicle speed may result in a loss of control of the vehicle and possible serious injury or death.**
- **The hill descent control system may not control the vehicle speed on a hill under all load or road conditions. Always be prepared to depress the brake pedal to control vehicle speed. Failure to do so may result in a collision or serious personal injury.**

CAUTION

When the hill descent control system operates continuously for a long time, the temperature of the Electronic Stability Programme (ESP) system actuator may increase and the hill descent control system may be temporarily disabled (the hill descent control system on indicator light will blink). If the indicator light does not come on continuously after blinking, stop using the system.

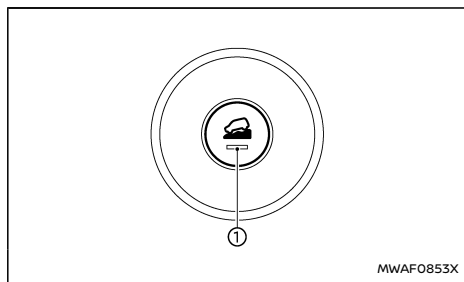
When the hill descent control system is activated, it automatically applies smooth brakes to control

speed on a steep and slippery descent or off the road without brake or accelerator operation.

The hill descent control system helps maintain vehicle speed when driving under 30 km/h (19 MPH) on a steep descent that engine braking alone in Four-Wheel Drive (4WD) mode cannot control the speed.

When driving forward on the descent, the speed can be adjusted by the brake or accelerator operation. The system maintains the speed for reverse driving on the descent.

HILL DESCENT CONTROL SWITCH



When additional braking is required on steep downhill roads, activate the hill descent control system by pushing the hill descent control switch on.

When the hill descent control system is activated, the hill descent control system on indicator light ① and the hill descent control system on indicator light on the meter will illuminate. (See "Hill descent

control system on indicator light (where fitted)" (P.89).) Also, the brake/tail lights illuminate while the hill descent control system is applying the brakes to control the vehicle speed.

To activate the hill descent control system, satisfy all of the following conditions:

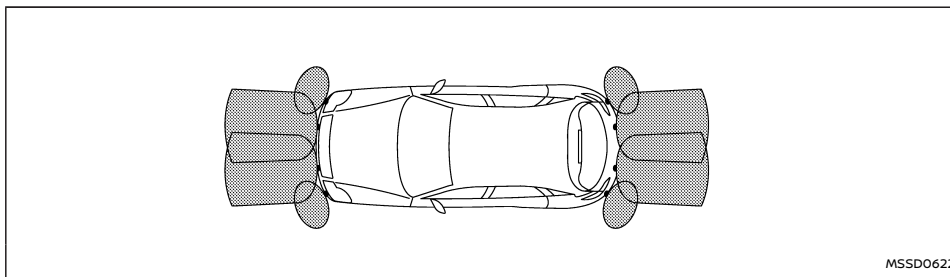
- Shift the transmission to the forward or reverse gear.
- Turn the Drive Mode Selector to the [OFF-ROAD] or [SNOW] mode and drive the vehicle at a speed under 30 km/h (19 MPH) (4WD models).
- Push the hill descent control switch to the ON position.

If the accelerator or brake pedal is depressed while the hill descent control system is on, the system will stop operating temporarily. As soon as the accelerator or brake pedal is released, the hill descent control system begins to function again if the hill descent control operating conditions are fulfilled.

The hill descent control system on indicator light blinks if the hill descent control switch is on and all conditions for system activation are not met, or if the system becomes disengaged for any reason.

To turn off the hill descent control system, push the hill descent control switch to the OFF position.

PARKING SENSOR (sonar) SYSTEM



Example

The parking sensor (sonar) system sounds a tone to inform the driver of obstacles near the bumper.

When the parking sensor (sonar) system is turned on, the parking sensor (sonar) view will automatically appear in the vehicle information display.

WARNING

- The parking sensor (sonar) system is a convenience but it is not a substitute for proper parking.
- The driver is always responsible for safety during parking and other manoeuvres. Always look around and check that it is safe to do so before parking.
- If there is any doubt the surroundings in the path of the parking area and/or the parking area itself are not free from obstacles, immediately stop the vehicle and check the surroundings.
- Read and understand the limitations of the parking sensor (sonar) system as con-

tained in this section. The colours of the parking sensor indicator and the distance guide lines in the front (where fitted)/rear view indicate different distances to the object.

- Inclement weather or ultrasonic sources such as an automatic car wash, a truck's compressed-air brakes or a pneumatic drill may affect the function of the system; this may include reduced performance or a false activation.
- The parking sensor (sonar) system is designed as an aid to the driver in detecting large stationary objects to help avoid damaging the vehicle.
- The parking sensor (sonar) system is not designed to prevent contact with small or moving objects. Always move slowly. The system will not detect small objects below the bumper, and may not detect objects close to the bumper or on the ground.

- The parking sensor (sonar) system may not detect the following objects: fluffy objects such as snow, cloth, cotton, glass-wool, etc.; thin objects such as rope, wire and chain, etc.; or wedge-shaped objects.
- The front and rear parking sensors (sonar) detect the distance between the vehicle and the obstacle by detecting the sound wave reflected from the surface of the obstacle. When there is a sound such as a horn, or an ultrasonic source (such as sonar of other vehicles) around the vehicle, the sensor (sonar) may not detect objects properly.

If your vehicle sustains damage to the bumper fascia, leaving it misaligned or bent, the sensing zone may be altered causing inaccurate measurement of obstacles or false alarms.

CAUTION

- Excessive noise (such as audio system volume or an open vehicle window) will interfere with the tone and it may not be heard.
- In some conditions (for example, after a car wash or a rain) water can accumulate around the parking sensors (sonar), and this may reduce performance of the system or cause a false activation. This water will drain away automatically while driving, bringing the system performance back to normal.
- Keep the parking sensors (located on the bumper fascia) free from snow, ice and

large accumulations of dirt. Do not clean the sonar with sharp objects. If the sensors are covered, the accuracy of the parking sensor (sonar) function will be diminished.

SYSTEM OPERATION

The system informs with a visual and audible alert of:

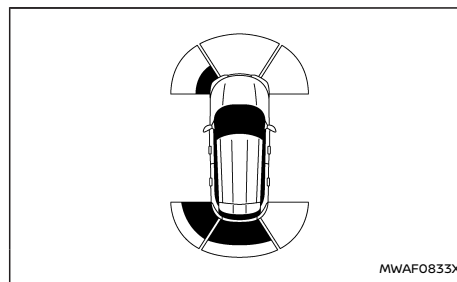
- front obstacles when the shift lever is in the D (Drive) position (where fitted)
- front and rear obstacles when the shift lever is in the R (Reverse) position

How the system alert of obstacles:

The system is deactivated at speeds above 10 km/h (6 MPH). It is reactivated at lower speeds.

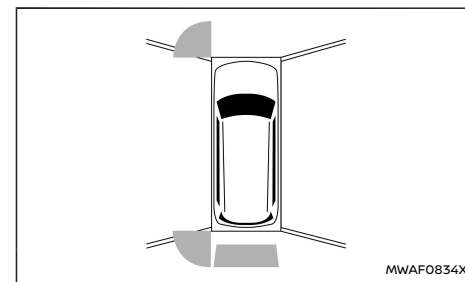
The tone will stop when the obstacle gets away from the vehicle.

When the object is detected, the indicator (green) appears and blinks and the tone sounds intermittently. When the vehicle moves closer to the object, the colour of the indicator turns yellow and the rate of the blinking increases. When the vehicle is very close to the object, the indicator stops blinking and turns red, and the tone sounds continuously.



Example

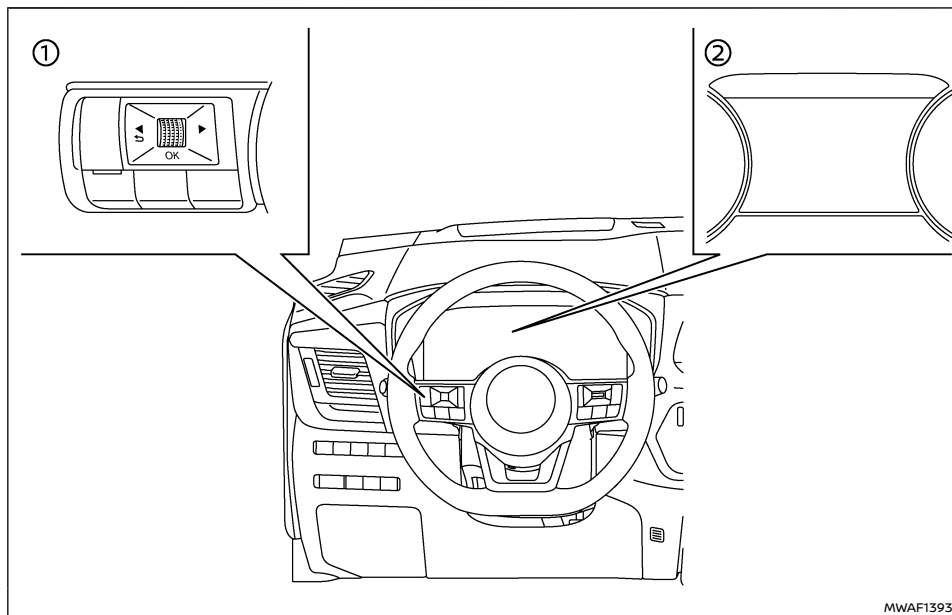
When the vehicle moves closer to an obstacle, the parking sensor indicator (detected area) appears in the vehicle information display.



Example

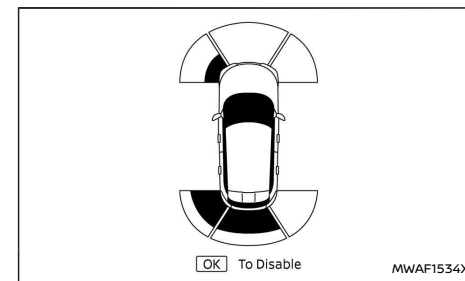
The parking sensor indicator also appears on the camera view of the centre display (where fitted).

TURNING ON AND OFF THE PARKING SENSOR (sonar) FUNCTION



- ① Steering-wheel-mounted control (left side)
- ② Vehicle information display

The system is automatically activated when the power switch is in the ON position and the shift lever is in the D (Drive) (models with front sensors) or R (Reverse) position.



Example

NOTE:

When the shift lever is in the R (Reverse) position and the Parking Aids screen is displayed in the vehicle information display, the parking sensor (sonar) system can be disabled temporarily by pushing the scroll dial on the steering wheel.

Perform the following steps to set up the parking sensor (sonar) system function.

1. Push the ◀ ▶ button until [Settings] appears in the vehicle information display and then push the scroll dial. Use the scroll dial to select [Driver Assistance]. Then push the scroll dial.
2. Select [Parking Aids] and push the scroll dial.
3. Use the scroll dial to navigate in the menu and select or change an item:
 - [Moving Object] (where fitted)
 - Turns ON/OFF the Moving Object Detec-

tion (MOD) (See “Moving Object Detection (MOD) (where fitted)” (P.216).)

- [Display]
 - Shows the parking sensor display in the vehicle information display when the parking sensor (sonar) system activates
- [Front]
 - Turns ON/OFF the front sensors
- [Rear]
 - Turns ON/OFF the rear sensors
- [Distance]
 - Changes the sensor’s detection distance to [Far], [Medium] or [Near]
- [Volume]
 - Changes the volume of the tone sound to [High], [Medium] or [Low]

PARKING SENSOR (sonar) SYSTEM LIMITATIONS

WARNING

Listed below are the system limitations for the parking sensor (sonar) system. Failure to operate the vehicle in accordance with these system limitations could result in serious injury or death.

- **Read and understand the limitations of the parking sensor (sonar) system as contained in this section. Inclement weather may affect the function of the sonar system; this may include reduced performance or a false activation.**

- **The parking sensor (sonar) system is deactivated at speeds above 10 km/h (6 MPH). It is reactivated at lower speeds.**
- **Inclement weather or ultrasonic sources such as an automatic car wash, a truck’s compressed-air brakes or a pneumatic drill may affect the function of the parking sensor (sonar) system; this may include reduced performance or a false activation.**
- **The parking sensor (sonar) system is not designed to prevent contact with small or moving objects. Always move slowly. The system will not detect small objects below the bumper or on the ground.**
- **The parking sensor (sonar) system may not detect the following objects: fluffy objects such as snow, cloth, cotton, glass-wool, etc.; thin objects such as rope, wire and chain, etc.; or wedge-shaped objects; complex-shaped objects or multiple objects in close.**
- **The parking sensor (sonar) system may not detect objects at speed above 5 km/h (3 MPH) and may not detect certain angular or moving objects.**
- **The parking sensor (sonar) system may not detect the following objects:**
 - Pedestrians who approach the vehicle from the side
 - Objects placed next to the vehicle
- **The parking sensor (sonar) system may not operate in the following conditions:**

- When rain, snow, ice, dirt, etc. adheres to the parking sensor.
- When a loud sound is heard in the area around the vehicle.
- When the surface of the obstacle is diagonal to the front or rear of the vehicle.
- When a parking sensor or the area around the sensor is extremely hot or cold.
- **The parking sensor (sonar) system may unintentionally operate in the following conditions:**
 - When there is overgrown grass in the area around the vehicle.
 - When there are bumps, protrusions or manhole covers on the road surface.
 - When the vehicle drives through a draped flag or a curtain.
 - When there is an accumulation of snow or ice behind the vehicle.
 - When driving on a steep hill.

SYSTEM TEMPORARILY UNAVAILABLE

When parking sensor blockage is detected, the system will be deactivated automatically.

The system is not available until the conditions no longer exist.

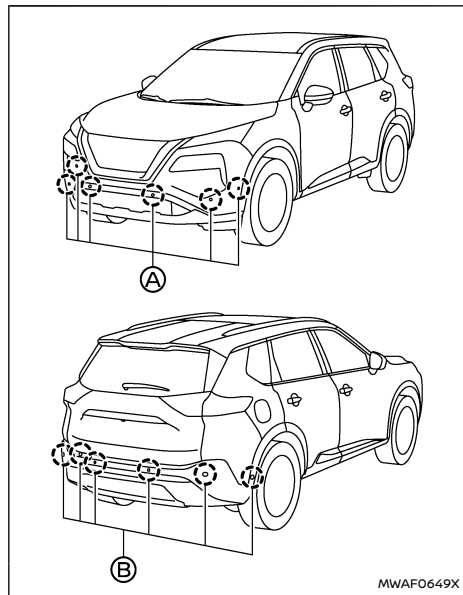
The parking sensors may be blocked by temporary ambient conditions such as splashing water, mist or fog. The blocked condition may also be caused

by objects such as ice, frost or dirt obstructing the parking sensors.

Action to take:

When the above conditions no longer exist, the system will resume automatically.

SYSTEM MAINTENANCE



Example

The parking sensors ① (4 or 6, where fitted) and ② (4 or 6) are located on the bumpers.

- Always keep the area near the sensors clean.
- If the sensors are dirty, wipe them off with a soft cloth while being careful to not damage them.
- The sensors may be blocked by temporary ambient conditions such as splashing water, mist or fog. The blocked condition may also be caused by objects such as ice, frost or dirt obstructing the sensors. Check for and remove objects obstructing the area around the sensors.
- Do not subject the area around the sensors to strong impact. Also, do not remove or disassemble the sensors. If the sensors and peripheral areas are deformed in an accident, etc., have the sensors checked. It is recommended that you visit a NISSAN dealer or qualified workshop for this service.
- Do not attach stickers (including transparent material), install accessories or apply additional paint on the sensors and their surrounding areas. This may cause a malfunction or improper operation.
- When washing the vehicle using a high-pressure washer, do not apply direct washer pressure on the sensors. This may cause a malfunction of the sensors.

PROPILOT PARK (where fitted)

ProPILOT Park is a function that supports parallel parking, reverse bay parking, and forward bay parking.

It uses the camera system and parking sensor (sonar) to detect the parking position, and controls the accelerator, brake, steering wheel, and shifting operations in order to support the series of parking operations.

⚠ WARNING

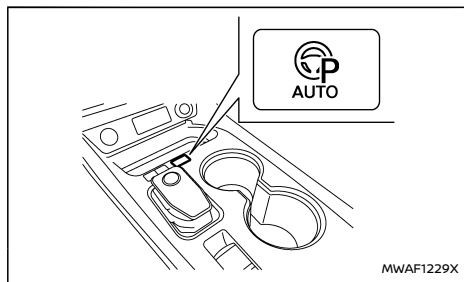
- **There is a limit to ProPILOT Park performance.**

The responsibility for safe driving is borne by the driver. Therefore, in the same way as with ordinary driving, check the surrounding conditions directly by visual confirmation or using the mirrors. Apply the brakes to stop the vehicle if it appears that the vehicle will hit a surrounding vehicle, person, or object.

- **There are limitations to the parking sensor (sonar) and cameras. The parking positions or steering cut backs may not be adjusted correctly because the system cannot detect the obstacles.**
- **Do not touch the spokes of the steering wheel during steering control.**

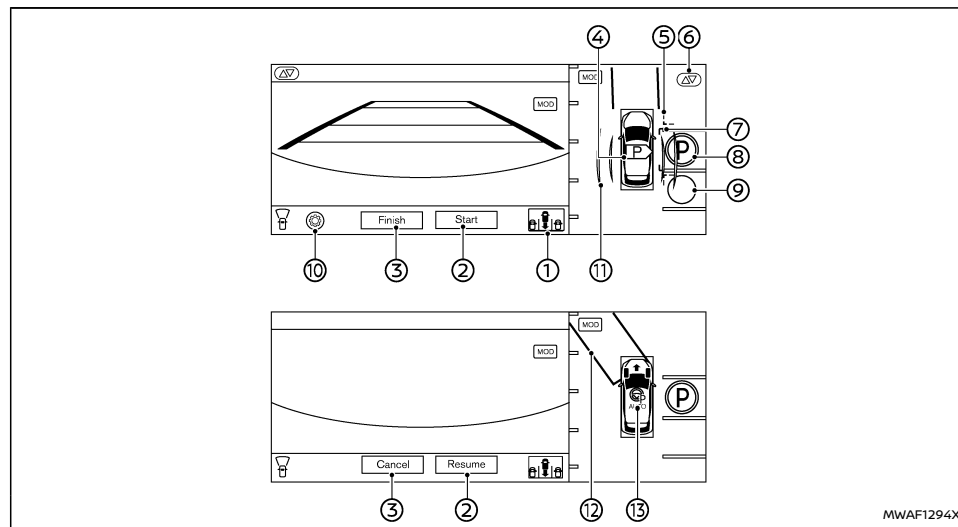
There is the possibility that hands or fingers may become caught, causing injury. Also, exercise sufficient caution so that neckties, scarves, and other item do not become caught. There is the possibility of an unexpected accident.

PROPILOT PARK SWITCH







Push this switch to activate ProPILOT Park. ProPILOT Park is displayed on the navigation system screen.


PROPILOT PARK SCREEN





- 1. Parking method selection icon:**
 Indicates the parking method that is currently selected. Touch to change the parking method. Refer to "Selecting the parking method" (P.383).
- 2. [Start]/[Resume]:**
 Touch this key to start the ProPILOT Park control.
- 3. [Finish]/[Cancel]:**
 Touch this key to deactivate ProPILOT Park.
- 4. Parking space detection icon:**
 Indicates which side of parking space is detected during parking space search.
 - : A parking space is detected on the right side.
 - : A parking space is detected on the left side.

5. **Clearance Guidelines (red):**
Indicates the approximate area that the vehicle will pass through when parking control is active.
6. **Parking guide box adjustment icon ():**
Touch this key to adjust the location of the parking guide box. Refer to "Adjusting the parking position" (P.390).
7. **Parking guide box (green):**
This indicates the approximate position where the vehicle will be parked. The box turns light blue when parking control is active.
8. ** sign (blue):**
Indicates the position where the vehicle will be parked.
9. ** sign (colourless):**
Indicates a selectable parking position besides the selected parking position. When touched, the icon will change to blue.
10. **Settings icon ():**
Touch this icon to change the ProPILOT Park settings.
11. **Parking space search area guidelines (light green):**
Indicates that the system is currently searching for a parking space. Lines are also used as a guide for vehicle positioning during space searching. Refer to "About the ProPILOT Park parking methods" (P.388).
12. **Direction change position rectangle (green):**

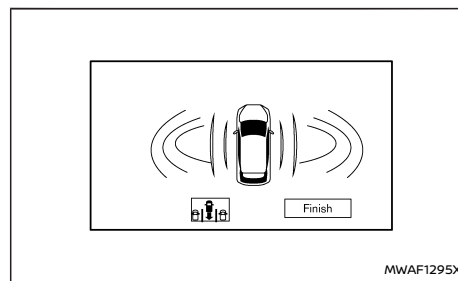
Indicates the position at which to make the next shift change.

13. **ProPILOT Park control icon ():**
The ProPILOT Park control status is indicated by colours.
Green: The parking control is active.
Grey: The parking control is not active.

NOTE:

When the wipers are operating or when water or other substances on the camera lens is detected, the  sign is displayed. When the  sign is displayed, the detectable parking positions are restricted.

When vehicle speed becomes 10 km/h or higher



When the vehicle speed becomes approximately 10 km/h (6 MPH) or higher while parking position detection is in progress, the screen changes. When the vehicle speed drops to approximately 10 km/h

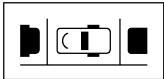
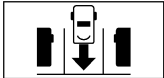
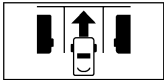
(6 MPH) or less, the screen returns to the regular ProPILOT Park screen.

SELECTING THE PARKING METHOD

The parking method can be changed by touching the parking method selection icon before touching [Start].

The parking method changes each time the parking method selection icon is touched. The vehicle will only scan for the type of parking method that has been selected.

Available methods

Parallel parking 	Supports reversing into a parking space where vehicles are parked in line with one another.
Bay reverse parking 	Supports reversing into a Bay parking space defined by lines.
Bay forward parking 	Supports parking forward into a bay parking space defined by lines.


PROPILOT PARK OPERATION

Parallel parking

1. **Drive forward at reduced speed.**
2. **Push the ProPILOT Park switch.**

ProPILOT Park activates.

3. **Drive slowly forward and the system will search for a parking space.**

The system will provide a chime and indicates  when a parking spot is detected and when the vehicle has reached the correct position ready to start the parking process. Depress the brake pedal to stop the vehicle.

4. **Keep the brake pedal depressed and touch [Start] on the screen.**

The ProPILOT Park control icon turns green and the brakes are applied automatically to keep the vehicle stopped. Parking control cannot be started if the system determines that movement to the parking position is not possible due to an obstacle detected by the parking sensors (sonar) and cameras.

In that case, park the vehicle manually.

5. **Release the brake pedal and the vehicle moves toward the direction change position rectangle (in the direction of the arrow on the vehicle icon).**

Depress the brake pedal and adjust the vehicle speed depending on the surrounding conditions.

6. **When the vehicle enters the next direction change position rectangle (green), the shift lever automatically changes.**

If it is not possible to proceed until the vehicle reaches the direction change position rectangle (green) because of an obstacle, depress the brake pedal and stop the vehicle near the obstacle. Change the shift lever position to change the direction. Refer to "Changing the direction of parking control travel" (P.391).

7. **When the vehicle is in the parking guide box (light blue), the vehicle stops and parking control ends.**

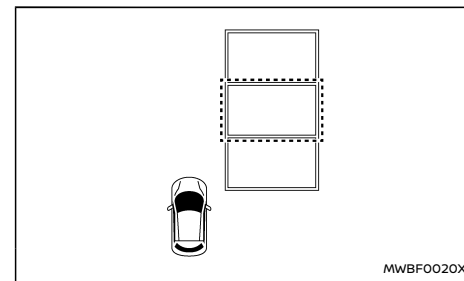
A sound and the display notify the driver when parking control ends.

At this time, the shift position changes to P (Park) and the electric parking brake is activated.

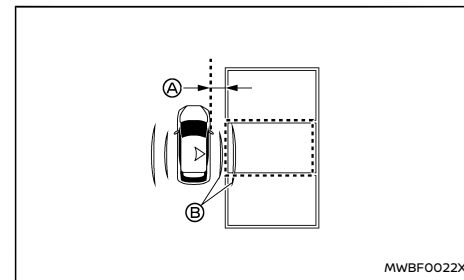
Parking control may end automatically before the vehicle is in the parking guide box (light blue). Refer to "Automatic deactivation while parking control in progress (while vehicle is in motion)" (P.387).


If it is not possible to reach the parking guide box due to an obstacle or some other reason, depress the brake pedal to stop the vehicle, then touch [Cancel] on the screen to deactivate ProPILOT Park. Park the vehicle manually or move the vehicle to a more suitable position.

Bay parking




1. **Stop the vehicle near the place you wish to park.**
2. **Push the ProPILOT Park switch.**
ProPILOT Park activates.



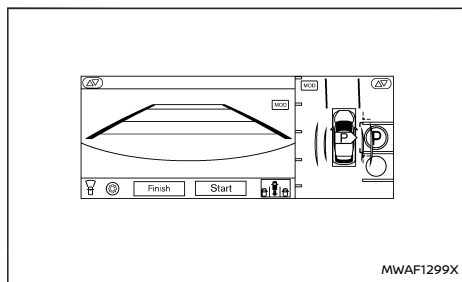
 Approximately 1 m (3 ft)

Ⓑ Parking space search area guidelines (light blue)

3. **Drive slowly forward and stop next to the desired parking space (at a distance of approximately 1 m (3 ft)).**

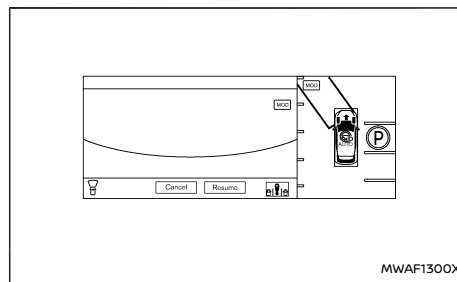
Stop the vehicle so that the parking space detection icon  is pointing near the centre of the desired parking space. See "Bay parking" (P.389).

Position the vehicle so that the end line of the parking space is in between the parking space search area guidelines (light blue) for easier detection.




4. **While the vehicle is stopped, check that Ⓟ is displayed in the desired parking space.**

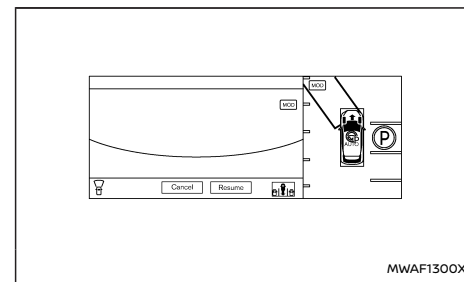
Check that it is possible to park in the space indicated by Ⓟ. Check that there are no obstacles in the parking space and the surrounding area, and check that the space is large enough to park in.



5. **Keep the brake pedal depressed and touch [Start] on the screen.**

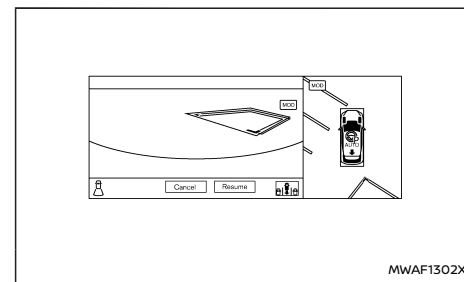
The ProPILOT Park control icon  turns green and the brakes are applied automatically to keep the vehicle stopped. Parking control cannot be started if the system determines that movement to the parking position is not possible due to an obstacle detected by the parking sensors (sonar) and cameras.

In that case, park the vehicle manually.



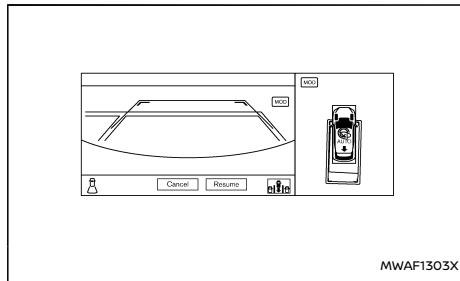
6. **Release the brake pedal and the vehicle moves toward the direction change position rectangle (in the direction of the arrow on the vehicle icon).**

Depress the brake pedal and adjust the vehicle speed depending on the surrounding conditions.



7. **When the vehicle enters the direction change position rectangle (green), the shift position automatically changes and the vehicle moves backwards.**

If it is not possible to proceed until the vehicle reaches the direction change position rectangle (green) because of an obstacle, depress the brake pedal, and stop the vehicle near the obstacle. Change the shift lever position to change the direction. Refer to “Changing the direction of parking control travel” (P.391).



8. **When the vehicle is in the parking guide box (light blue), the vehicle stops and parking control ends.**

A sound and the display notify the driver when parking control ends.




At this time, the shift position changes to P (Park) and the electric parking brake is activated.

Parking control may end automatically before the vehicle is in the parking guide box (light

blue). Refer to “Automatic deactivation while parking control in progress (while vehicle is in motion)” (P.387).

If it is not possible to reach the parking guide box due to an obstacle or some other reason, depress the brake pedal to stop the vehicle, then touch [Cancel] on the screen to deactivate ProPILOT Park. Park the vehicle manually or move the vehicle to a more suitable position.

NOTE:

- ProPILOT Park can also be activated by pushing <CAMERA> button and then touching  on the Intelligent Around View Monitor screen.
- While ProPILOT Park is activated, the volume of the audio system and other sounds are reduced.
- If the parking guide box does not display a position where parking is actually possible (due to the presence of an obstacle or a street gutter), manually set a suitable parking position. Refer to “Adjusting the parking position” (P.390).
- If the [Detect parallel spaces on both side] setting is activated and parking spaces are detected on both sides. The turn signal switch can be used to select the desired side if parking spaces on both sides are detected.
- Even if the system detects the parking space once, the detected parking space may disappear or parking may not be started depending on the circumstances of obstacles such as the width of the aisle.
- When parking control is started, the parking sensor (sonar) function automatically turns on. When ProPILOT Park deactivates, the parking sensor (sonar) returns to the condition that it was set to on the vehicle information display.
- While parking control is active, the screen will not change even if  or  key is touched.
- Pushing the <CAMERA> button deactivates ProPILOT Park. For additional details, see “ProPILOT Park deactivation” (P.387).
- Parking control cannot be started in the following cases. After the conditions are corrected, parking control can be started.
 - The driver's seat belt is not fastened.
 - The shift position is in P (Park).
 - The shift position is in R (Reverse).
 - The electric parking brake is activated.
 - The ESP system is turned off.
- Parking control cannot be started when the vehicle is on a steep slope. Park the vehicle manually.
- When the ProPILOT Park system changes the driving direction of the vehicle there is a slight pause.
- Parking control may automatically end when the system determines that movement to the parking position is not

possible due to an obstacle detected by the parking sensors (sonar) or cameras. Move the vehicle to a more suitable position.

- If the Clearance Guidelines contact a parked vehicle or another obstacle, the parking sensor (sonar) may detect an obstacle and stops the vehicle, hindering the system from completing the parking procedure.
- The turn signal is activated automatically, in the direction of the parking space when touching [Start] on the screen.
- The route to the parking position and the number of steering cut backs vary depending on the set parking position and the position of the obstacles detected by the parking sensors (sonar) and cameras.
- The [Unavailable Mirrors in folded position] message may be displayed even though the mirror is open. In that case, close and open the mirror again.

PROPILOT PARK PAUSE

Automatic stop of parking control

In the following cases, the brakes are applied automatically and the vehicle stops.

- An obstacle in the direction of travel was detected.
- The driver's seat belt was unfastened.

Parking control can be resumed by touching [Resume] on the screen while depressing the brake

pedal after confirming that the conditions have been corrected.

NOTE:

- When parking control is resumed, the shift position automatically changes to D (Drive) or R (Reverse).
- When parking control is resumed after the vehicle was stopped due to detection of an obstacle, the direction of travel changes and steering cut backs are used to continue parking control.
- Parking control cannot be resumed when the system determines that movement to the parking position is not possible due to an obstacle detected by the parking sensors (sonar) and cameras.
- Parking control cannot be resumed if the driver's seat belt is not fastened.

PROPILOT PARK DEACTIVATION

Touch [Finish] or [Cancel] on the screen to deactivate ProPILOT Park.

If ProPILOT Park is deactivated while parking control is in progress, the brakes are applied automatically, the vehicle stops, and the electric parking brake is activated. At this time, the shift position changes to P (Park).


Automatic deactivation during parking position detection

WARNING

Depress the brake pedal if ProPILOT Park automatically deactivates during parking position detection. The brakes are not automati-

cally applied and it may cause an unexpected accident.

In the following cases, ProPILOT Park automatically deactivates.

- The door of the driver seat, passenger seat, either rear seat or the back door was opened.
- The vehicle drove 500 m or more after ProPILOT Park was activated.
- Vehicle speed exceeded approximately 30 km/h.
- The outside mirrors were folded.
- The screen was switched by pushing the <CAMERA> button or touching the  key, etc.
- A system malfunction was detected.

Automatic deactivation while parking control in progress (while vehicle is in motion)

In the following cases, ProPILOT Park deactivates automatically.

If ProPILOT Park is deactivated automatically while parking control is in progress, the brakes are applied automatically, the vehicle stops, and the electric parking brake is activated. At this time, the shift position changes to P (Park).

- The driver operates the steering wheel.
- The driver operates the accelerator pedal.
- The driver's door, front passenger's door, either of the rear doors or the back door was opened.

- The electric parking brake was activated.
- The shift position was changed to P (Park), N (Neutral), D (Drive) or R (Reverse).
- The **<CAMERA>** button was pushed.
- The outside mirrors were folded.
- The ProPILOT Park switch was pushed.
- The system determined that movement to the parking position is not possible due to an obstacle or some other reason.
- The system decided that there was a large deviation in the parking position used for parking control.
- The ESP system was turned off.
- The ESP/TCS/ABS was activated.
- The vehicle speed exceeded approximately 8 km/h.
- A system malfunction was detected.
- Any of the following conditions are met in a location close to the parking position.
 - An obstacle in the parking path was detected.
 - The driver's seat belt was unfastened.

Automatic deactivation while parking control in progress (while vehicle is not in motion)

In the following cases, the user is notified by sound and the display and ProPILOT Park automatically deactivates.

At this time, the electric parking brake is activated and the shift position changes to P (Park).

- The driver's door, front passenger's door,

either of the rear doors or the back door was opened.

- The driver operates the accelerator pedal.
- The electric parking brake was activated.
- The shift position was changed to N (Neutral) or P (Park).
- 1 minute or more passed after ProPILOT Park is in pausing status.
- The **<CAMERA>** button was pushed.
- The outside mirrors were folded.
- The ESP system was turned off.
- The ESP/TCS/ABS was activated.
- A system malfunction was detected.
- The ProPILOT Park switch was pushed.

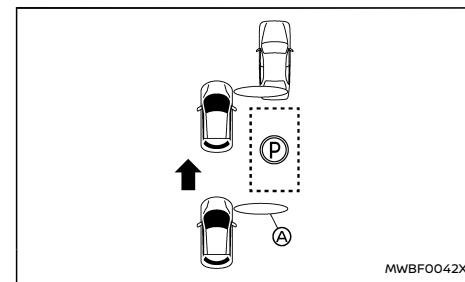
ABOUT THE PROPILOT PARK PARKING METHODS

Parallel parking (sonar detection)

Pass the parking position at a distance of less than approximately 1 m (3 ft) **A** next to the desired parking place.

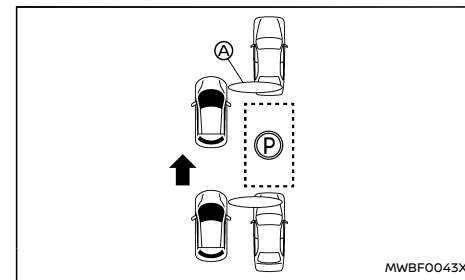
If the distance from the parking position is too large, it may not be possible to detect obstacles.

Parking position accuracy depends on object position and angle.



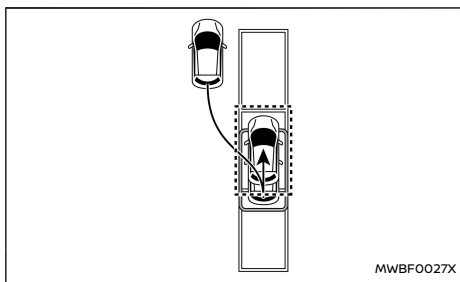
Example with parking space before obstacle

A Sensor detection range



Example with parking space between obstacles

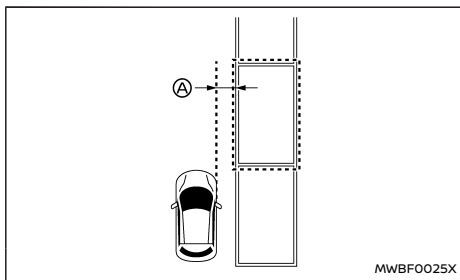
A Sensor detection range



Parking is performed using a route such as that shown in the illustration.

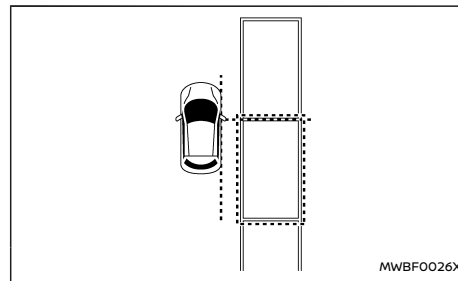
The parking route and number of switch-backs vary depending on the parking position and the positions of the surrounding obstacles.

Parallel parking (Line detection)



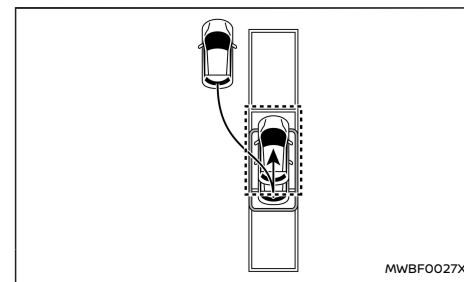
Approach the parking position at a distance of approximately 1 m (3 ft) (A) next to the desired parking place.

If the distance from the parking position is too large, it may not be possible to detect obstacles or the parking space lines. Refer to "Parking position detection function" (P.391).



Drive slowly forward and depress the brake pedal to stop the vehicle when parallel to the parking position.

Stop the vehicle so that the front doors are positioned at the forward edge of the desired parking space.

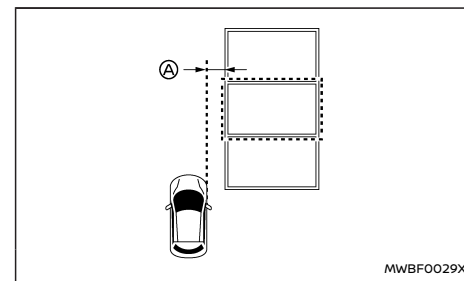


Example: route starting backwards

Parking is performed using a route as shown in the illustration. Depending on the obstacles and distance to the parking position, parking operation may start by reversing.

The parking route and number of switch-backs vary depending on the parking position and the positions of the surrounding obstacles.

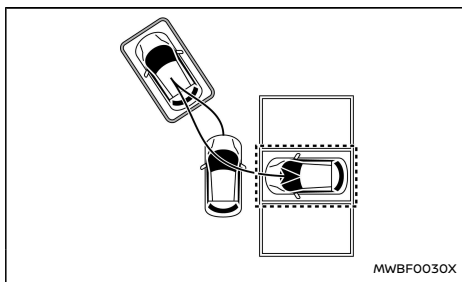
Bay parking



Approach the parking position at a distance of approximately 1 m (3 ft) **A** next to the desired parking place.

If the distance from the parking position is too large, it may not be possible to detect obstacles, or it may not be possible to detect the parking space lines. Refer to "Parking position detection function" (P.391).

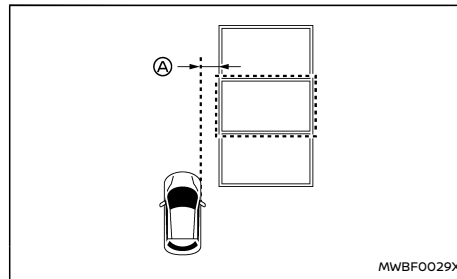
Drive slowly and stop the vehicle so that the vehicle is perpendicular to the parking space. Stop the vehicle to position the front doors are at the centre of the desired parking space.



Parking control is performed using a route as shown in the illustration.

The parking route and number of switch-backs vary depending on the parking position and the positions of the surrounding obstacles.

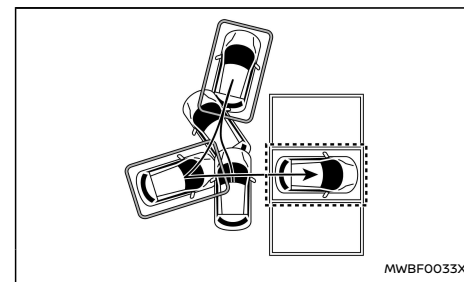
Forward parking



Approach the parking position at a distance of approximately 1 m (3 ft) **A** next to the desired parking place.

If the distance from the parking position is too large, it may not be possible to detect obstacles or the parking space lines.

Drive slowly and stop the vehicle so that the vehicle is perpendicular to the parking space. Stop the vehicle to position the front doors are at the centre of the desired parking space.

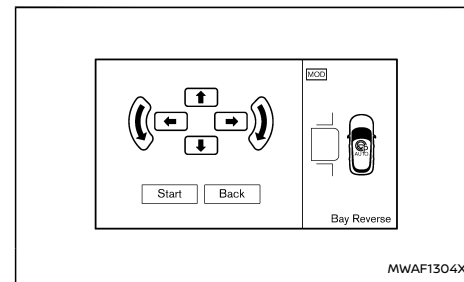


Parking control is performed using a route as shown in the illustration.

The parking route and number of switch-backs vary depending on the parking position and the positions of surrounding obstacles.

ADJUSTING THE PARKING POSITION

The parking position can be adjusted manually when parallel parking or bay parking is selected as a parking method.



1. Depress the brake pedal and stop the vehicle, then touch the parking guide box adjustment icon (⚙️) on the screen.

When (P) is displayed, the parking guide box is displayed in the (P) position.

If no parking position is detected or parking position is off the screen, the parking guide box is displayed in the default position.

2. Touch the arrow on the screen for fine adjustments.

NOTE:

- The displayed Clearance Guidelines indicate the guides of the area where a part of the vehicle may enter when moving to the parking position. Smooth parking is possible when vehicles, poles, and other obstacles are on the outside of the Clearance Guidelines.
- Touch the left side of the screen to move the parking guide box.
- The parking guide box direction can be changed by operating the turn signal switch.

CHANGING THE DIRECTION OF PARKING CONTROL TRAVEL

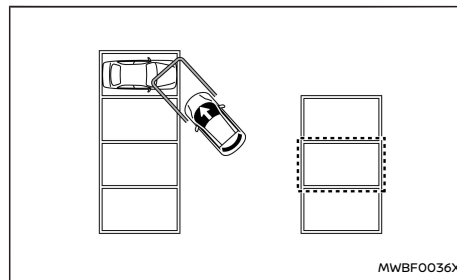
If there is an obstacle (such as a pole) or a location lower than ground level (such as a ditch or cliff) in the vehicle's direction of travel, depress the brake pedal to stop the vehicle.

Use the shift lever to change the direction of travel to resume parking control.

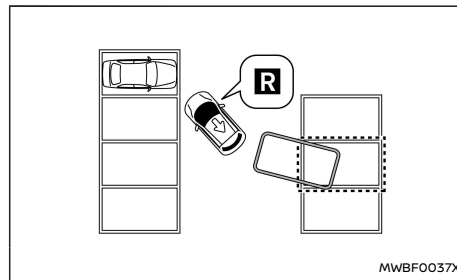
NOTE:

Parking control cannot be resumed if the system determines that movement to the parking space is not possible due to an obstacle detected by the parking sensors (sonar) or cameras.

(Example) When there is a parked vehicle



1. Depress the brake pedal to stop the vehicle.



2. Use the shift lever and change the direction of travel.

When [Resume] is touched, parking control is resumed.

PARKING POSITION DETECTION FUNCTION

The cameras and parking sensors (sonar) are used to detect the parking position. Multiple parking positions can be detected.

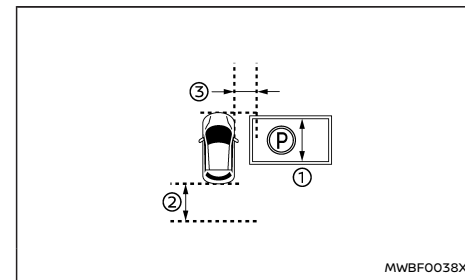
The parking space lines are recognised using the cameras, and the parking positions are displayed.

A parking position is not displayed if the parking sensors (sonar) detect an obstacle inside the detected parking space.

NOTE:

If the lens of the front view, side view, or rear view camera is dirty or there are water drops or some other substance adhering to it, the detectable parking positions may be restricted.

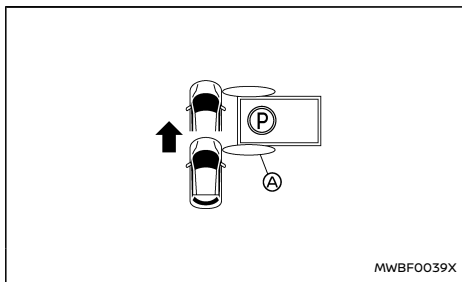
When bay parking or forward parking is selected



- ① Approximately 2.3 m (8 ft).
- ② Approximately 2 m (6 ft).
- ③ Approximately 1 m (3 ft).

A parking position is detected under the following conditions:

- Parking spaces of approximately 2.3 to 2.5 m (6.5 to 8 ft) width ① are recognised.
- Parking space lines composed of single lines or U-shaped space lines are recognised.
- Parking space lines with a width of approximately 15 cm (6 in) are recognised.
- Recognition occurs when there are parking space lines located within the range from the front edge of the vehicle to approximately 2 m (6 ft) from the rear edge of the vehicle ②.
- Recognition occurs when a parking space is located approximately 1 m (3 ft) from the vehicle ③.
- If [Detect parallel spaces on both sides] is turned on, parking positions on both sides of the vehicle are detected. Refer to "ProPILOT Park settings" (P.394).

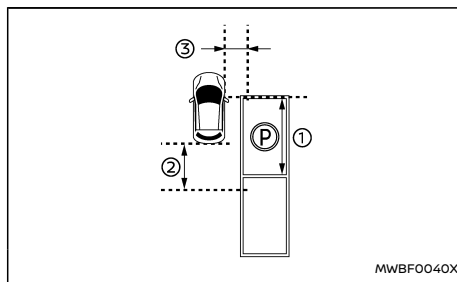


Ⓐ Sensor detection range

A parking position is not displayed when the detection range of the front sensors (sonar) passes through the parking space detected by cameras and an obstacle is detected.

Obstacles in parking spaces located beyond the sensor detection range cannot be detected.

When parallel parking is selected

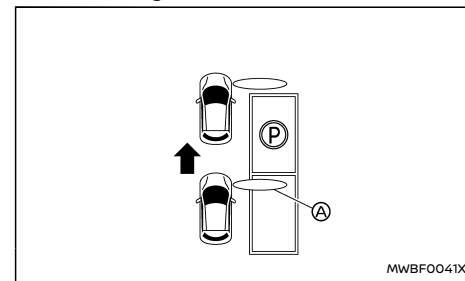


- ① Approximately 5 m (15 ft).
- ② Approximately 3 m (10 ft).
- ③ Approximately 1 m (3 ft).

A parking position is detected under the following conditions.

- Parking spaces of approximately 5 to 6 m (15 to 18 ft) length ① are recognised.
- Parking space lines composed of single lines are recognised.
- Parking space lines with a width of approximately 15 cm (6 in) are recognised.

- Recognition occurs when there are parking space lines located within the range from the driver's door to approximately 3 m (10 ft) from the rear edge of the vehicle ②.
- Recognition occurs when a parking space is located approximately 1 m (3 ft) from the vehicle ③.
- If [Detect parallel spaces on both sides] is turned on, parking positions on both sides of the vehicle are detected. Refer to "ProPILOT Park settings" (P.394).



Ⓐ Sensor detection range

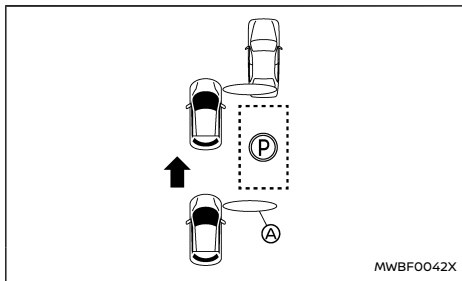
A parking position is not displayed when the detection range of the front sensors (sonar) passes through the parking space detected by cameras and an obstacle is detected.

Obstacles in parking spaces located beyond the sensor detection range cannot be detected.

If the parking space lines are not recognised, the parking sensors (sonar) are used to detect the

parking space based on the surrounding obstacles.

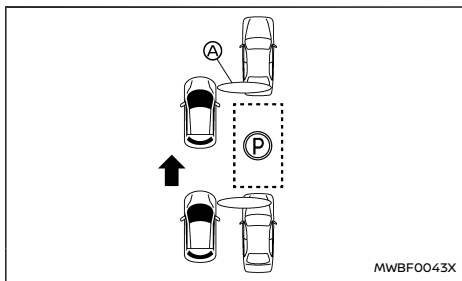
Depending on the positions and angles of the surrounding obstacles, the parking guidance box may deviate.



MWBFO042X

Example with parking space before obstacle

(A) Sensor detection range



MWBFO043X

Example with parking space between obstacles

(A) Sensor detection range

CAMERAS AND PARKING SENSORS (sonar) USED FOR PROPILOT PARK

Cameras

The Intelligent Around View Monitor cameras are used.

For maintenance, see "System maintenance" (P.216).

Parking sensors (sonar)

12 parking sensors (sonar) located on the front, rear, left, and right are used.

For maintenance, see "System maintenance" (P.381).

PROPILOT PARK PRECAUTIONS

⚠ WARNING

- Never attempt to drive while looking only at the screen. There is the risk of hitting an obstacle or causing an unexpected accident.
- Pay attention to the movement of vehicles and persons in the surrounding area. Parking support is provided by making effective use of the detected path. Pay attention to the movements of oncoming vehicles, following vehicles, and pedestrians when operating parking control.
- When parking support by ProPILOT Park is no longer necessary, deactivate ProPILOT Park. If ProPILOT Park remains activated, there is the risk of an unexpected accident.

- Before exiting the vehicle, check that the electric parking brake is activated and that the shift position is in P (Park).
- Before using ProPILOT Park, check directly to confirm that there is sufficient space around the vehicle for the steering cut backs and other parking operations to be performed.
- Depending on the circumstances, noise from inside or outside the vehicle may prevent the driver from hearing the warning sound.
- Operate the turn signal switch during parking control to inform the surroundings of the vehicle moving direction.
- Do not use ProPILOT Park in the following circumstances:
 - In a location where the traffic is heavy with persons and vehicles
 - In a location where stopping or parking is prohibited
 - In a location that is too narrow for the vehicle to fit
 - In a location where parking is not possible due to a hole, ditch, etc.
 - In a location where the street width is narrow
 - On a steep slope
 - On a gravel, dirt, or unpaved road
 - On a slippery surface, such as snow or ice


- On a road that is not flat due to inclination, steps, kerbs, wheel ruts, or other reasons
- On a road where the asphalt has melted due to exposure to excessive heat
- In a location where a road heater (heater for preventing the road surface from freezing) is installed in the parking area
- In a mechanical parking area or location where there are obstacles in the parking spaces
- When the vehicle is overloaded
- When worn tyres, an emergency tyre or tyre chains are being used
- When the tyre air pressure is not correct
- When a towing hook or similar item is installed
- When an object is attached that interferes with the camera's field of view
- When the camera images are difficult to see due to dirt, sunlight, shadows, or other reasons
- When the outside mirror is not all the way open
- When the cameras are not properly installed
- When an item is installed on the bumper that interferes with the parking sensors' (sonar) performance

- When there is a dent or other irregularity in the bumper
- When there is rain, snow, mud, or some other substance adhering to the parking sensors (sonar)
- When the loaded vehicle is tilted due to carrying an extremely heavy load or carrying a load only on one side

CAUTION


Car stops cannot be detected and there is some possibility that kerbs cannot be detected. Depress the brake pedal to stop the vehicle if the wheels appear to hit a kerb or the vehicle appears to pass over a car stop. There is the risk of damage to the vehicle.

PROPILOT PARK MALFUNCTIONS

If there is an abnormality in the system, a warning message is displayed on the screen, the colour of the ProPILOT Park control icon  changes to orange, and ProPILOT Park is automatically deactivated. If a warning is displayed while the system is in use, stop the vehicle in a safe location and place the power switch in the OFF position and then place it back in the ON position.

If it is not possible to activate ProPILOT Park after performing the above, there may be a malfunction in the system. This does not interfere with ordinary driving. However, the system should be inspected by a knowledgeable repairer such as a NISSAN dealer or qualified workshop.

PROPILOT PARK SETTINGS

1. Touch  on the launch bar.
2. Touch [Parking].
3. Select the setting item.

Available items:

- [Use the last selected parking mode]
When this item is turned on, the parking method that was most recently used will be selected.

When the item is turned off, parallel parking will be selected.

- [Detect parallel spaces on both side]
When this item is turned on, parking positions on the both sides of the vehicle will be detected.

When the item is turned off, only parking positions on the side last time ProPILOT Park used will be detected.

If the turn signal switch is operated in this state, parking spaces on that side of the vehicle will be detected.

- [Parking mode]
The parking methods which can be selected on the ProPILOT Park screen can be set.

The parking methods that are turned on can be selected each time the parking method selection icon is touched.

The parking methods that are turned off

cannot be selected by touching the parking method selection icon.

See also "Selecting the parking method" (P.383).

PARKING SENSOR (sonar) DETECTION CONDITIONS AND LIMITATIONS

WARNING

The parking sensor (sonar) system has some limitations. For details, see "Parking sensor (sonar) system limitations" (P.380).

- Under conditions such as the following, the brakes may be applied or correct parking control may not be possible.
 - When there is rain, snow, ice, dirt, or some other substance adhering to the parking sensors (sonar)
 - When there is a loud noise in the surrounding area
 - When there is a device generating ultrasound (including vehicles equipped with sensors (sonar)) in the surrounding area
 - When there is thick grass in the surrounding area
 - When passing near a structure with bumps or depressions
 - When there is a structure (such as a wall, toll collection equipment, or parking area gate) located nearby to the side of the vehicle
 - When there is a step, projecting object, or drain cover on the road

- When passing under a hanging flag, plastic curtain, or similar object
- When there are clumps of snow around the vehicle

INTELLIGENT AROUND VIEW MONITOR DETECTION CONDITIONS AND LIMITATIONS

WARNING

The Intelligent Around View Monitor has some limitations. For details, see "Intelligent Around View Monitor (where fitted)" (P.207).

- Under conditions such as the following, the Intelligent Around View Monitor cameras may be unable to detect an obstacle and/or the parking position correctly.
 - When the vehicle gets wet with rain or water
 - When the surroundings are dark, such as at night, when in underground locations or in an above-ground parking garage
 - When parking space lines are not clearly visible due to bad weather (rain, snow, fog, dust, sand or snowstorms)
 - When the camera lens is clouded due to contact with water
 - When strong light from the sun or streetlights shines on the road
 - When the road surface is wet and shining, such as during or after rain, or when there are puddles on the road
 - When sunlight shines into the camera, such as in the morning or in the evening

- When the camera lens is dirty or there are water drops adhering to it
- When an object is attached that interferes with the camera field of view
- When strong light (for example, sunlight or high beams from oncoming vehicles) enters the front camera
- When vehicle's driving posture changed significantly due to sudden braking or loads
- A sudden change in brightness occurs (for example, when the vehicle enters or exits a tunnel or shaded area or lightning flashes)
- When driving on a steep downhill or slope or roads with sharp curves
- People with postures other than upright standing or walking, such as leaning forward, etc.
- People in a vehicle
- People pushing shopping carts, strollers, etc.
- People in clothes such as raincoats or dresses whose outlines are obscured
- People who have an umbrella or a large bag and have a part of their body hidden
- A pedestrian's profile is not recognised because he or she has a large luggage or wearing a cloth of the same colour as the background

PROPILOT PARK DETECTION CONDITIONS AND LIMITATIONS

- Under conditions such as the following, the brakes may not be applied or correct parking control may not be possible.
 - When there is rain, snow, ice, dirt, or some other substance adhering to the parking sensors (sonar)
 - When there is a loud noise in the surrounding area
 - When there is a device generating ultrasound (including vehicles equipped with sensors (sonar)) in the surrounding area
 - When there is thick grass in the surrounding area
 - When passing near a structure with bumps or depressions
 - When there is a structure (such as a wall, toll collection equipment, or parking area gate) located nearby to the side of the vehicle
 - When there is a step, projecting object, or drain cover on the road
 - When passing under a hanging flag, plastic curtain, or similar object
 - When there are clumps of snow around the vehicle
- The system may not work properly under the following condition.
 - When the vehicle is equipped with non-original tyres
- Under conditions such as the following, correct parking control to the set position may not be possible. As necessary, move the vehicle to a more suitable position.
 - When the road surface is not flat
 - When the vehicle is tilted due to carrying an extremely heavy load or carrying a load only on one side
- Under conditions such as the following, it may be impossible or difficult to detect a parking position.
 - When the vehicle is too close to the parking space
 - In a parking area without parking space lines where the spaces are created with rope, blocks, or other means
 - When the parking space lines are not clearly visible due to fading or dirt
 - When the contrast between the road and parking space lines is low
 - When the parking space lines on the road are yellow or some other colour besides white
 - When the parking space is extremely narrow or wide
 - When the parking space lines are extremely short
 - When the parking space lines are extremely narrow or wide
 - When the parking space lines are not parallel in the camera image due to inclination of the parking area or some other reason
 - When the parking space lines are connected to diagonal lines or other markings
 - When the shadow of the vehicle, shade from trees, or other shadows are on the parking space lines
- When there is a neighboring vehicle or some other obstacle on the parking space lines
- When there is an obstacle in the parking space
- When the surroundings are dark, such as at night, when in underground locations or in an above-ground parking garage
- When parking space lines are not clearly visible due to bad weather (rain, snow, fog, dust, sand or snowstorms)
- When the camera lens is clouded due to contact with water
- When the sun or streetlights are reflecting on the road
- When strong light from the sun or streetlights shines on the road
- When the road surface is wet and shining, such as during or after rain, or when there are puddles on the road
- When sunlight shines into the camera, such as in the morning or in the evening
- When the camera lens is dirty or there are water drops adhering to it
- When an object is attached that interferes with the camera field of view
- When there is a step, gutter, road painting, repainted line, or similar item
- When there is accumulated snow or snow-melting agents

COLD WEATHER DRIVING

FREEING A FROZEN DOOR LOCK

To prevent a door lock from freezing, apply deicer through the key hole. If the lock becomes frozen, heat the key before inserting it into the key hole, or use the Intelligent Key system.

ANTI-FREEZE

In the winter when it is anticipated that the outside temperature will drop below 0°C (32°F), check the anti-freeze to assure proper winter protection. For additional information, see "Engine cooling system" (P.428) or "Inverter cooling system" (P.429).

12-VOLT BATTERY

If the 12-volt battery is not fully charged during extremely cold weather conditions, the 12-volt battery fluid may freeze and damage the 12-volt battery. To maintain maximum efficiency, the 12-volt battery should be checked regularly. For additional information, see "12-volt battery" (P.437).

DRAINING OF COOLANT WATER

If the vehicle is to be left outside without anti-freeze, drain the cooling system, including the engine block. Refill before operating the vehicle. For details, see "Engine cooling system" (P.428).

- When the parking area is paved with stones or greenery
- When there is a noise pattern image in the parking space on the screen
- When letters or other characters are painted in the parking space
- When the road colour and brightness are not even
- When the vehicle is stopped inclined relative to the parking space
- When the street width is narrow
- When there is an obstacle in front of the vehicle
- When there is rain, snow, ice, dirt, or some other substance adhering to the parking sensors (sonar)
- When there is a loud noise in the surrounding area
- When there is a device generating ultrasound (including vehicles equipped with sensor (sonar)) in the surrounding area
- When there is thick grass in the surrounding area
- When there is a step, projecting object, or drain cover on the road
- When there are clumps of snow around the vehicle
- Under conditions such as the following, the parking position may not be detected in the correct location.
 - When there is light that looks like parking space lines, the reflection of a building or other object, a step, gutter, road painting, repainted line, or similar items
 - When there are marks from road repairs, letters printed on the road, poles, or other obstacles
 - When the road surface is wet and shining, such as during or after rain, or when there are puddles on the road
 - When the road colour and brightness are not even
 - When the parking area is on a slope
 - When a side step of the vehicle or a shadow is on the parking space line
 - When the parking space lines are not clearly visible due to fading or dirt
 - When the system is affected by the shadows of the vehicle or shades of the trees
- When the vehicle is equipped with non-original tyres, correct parking control to the set position may not be possible. It is recommended that you visit a NISSAN dealer or qualified workshop when changing to winter tyres.

TYRE EQUIPMENT

1. If you have snow tyres installed on the front/rear wheels of your vehicle, they should be of the same size, loading range, construction and type (bias, bias-belted or radial) as the rear/front tyres.
2. If the vehicle is to be operated in severe winter conditions, snow tyres should be installed on all four wheels.
3. For additional traction on icy roads, studded tyres may be used. However, some countries, provinces and states prohibit their use. Check local, state and provincial laws before installing studded tyres.

Skid and traction capabilities of studded snow tyres, on wet or dry surfaces, may be poorer than that of non-studded snow tyres.

4. Snow chains may be used if desired. Make sure they are the proper size for the tyres on your vehicle and are installed according to the chain manufacturer's instructions. Use chain tensioners when recommended by the tyre chain manufacturer to ensure a tight fit. Loose end links of the tyre chains must be secured or removed to prevent the possibility of whipping action damage to the fenders or underbody. In addition, drive at a reduced speed, otherwise, your vehicle may be damaged and/or vehicle handling and performance may be adversely affected.

Four-Wheel Drive (4WD) models

If you install snow tyres, they must also be the same size, brand, construction and tread pattern on all four wheels.

SPECIAL WINTER EQUIPMENT

It is recommended that the following items be carried in the vehicle during winter:

- A scraper and stiff-bristled brush to remove ice and snow from the windows and wiper blades.
- A sturdy, flat board to be placed under the jack to give it firm support.
- A shovel to dig the vehicle out of snow-drifts.
- Extra window washer fluid to refill the reservoir tank.

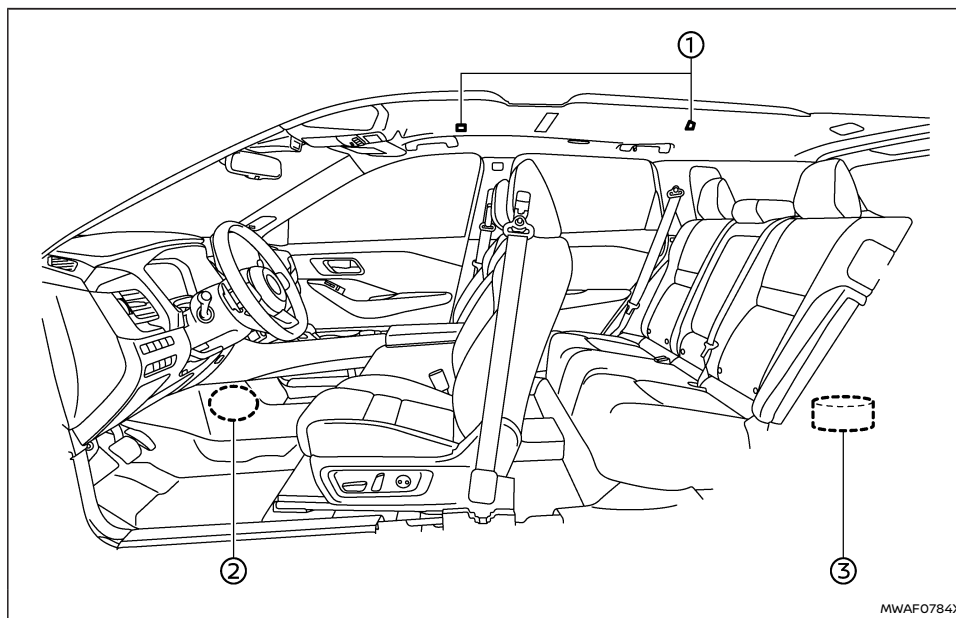
DRIVING ON SNOW OR ICE

WARNING

- **Wet ice (32°F, 0°C and freezing rain), very cold snow or ice can be slick and very hard to drive on. The vehicle will have much less traction or "grip" under these conditions. Try to avoid driving on wet ice until the road is salted or sanded.**
- **Whatever the condition, drive with caution. Accelerate and slow down with care. If accelerating or downshifting too fast, the drive wheels will lose even more traction.**
- **Allow more stopping distance under these conditions. Braking should be started sooner than on dry pavement.**

- **Allow greater following distances on slippery roads.**
- **Watch for slippery spots (glare ice). These may appear on an otherwise clear road in shaded areas. If a patch of ice is seen ahead, brake before reaching it. Try not to brake while on the ice, and avoid any sudden steering manoeuvres.**
- **Do not use cruise control on slippery roads.**
- **Snow can trap dangerous exhaust gases under your vehicle. Keep snow clear of the exhaust pipe and from around your vehicle.**

ACTIVE NOISE CANCELLATION/ACTIVE SOUND ENHANCEMENT



Example

NOTE:

To operate the active noise cancellation and active sound enhancement system properly:

- Do not cover the speakers or woofer.
- Do not cover the microphones.
- Do not change or modify speakers including the woofer and any audio related parts such as the amplifier.
- Do not make any modification including sound deadening or modifications around the microphones, speakers or woofer.

ACTIVE NOISE CANCELLATION

The active noise cancellation uses microphones ① located inside the vehicle to detect engine booming noises. The system then automatically produces a muted engine booming noise through the speakers ② and woofer ③ to reduce engine booming noise.

If the microphones ① or the area around it is tapped, abnormal noise may be output from the speaker.

ACTIVE SOUND ENHANCEMENT

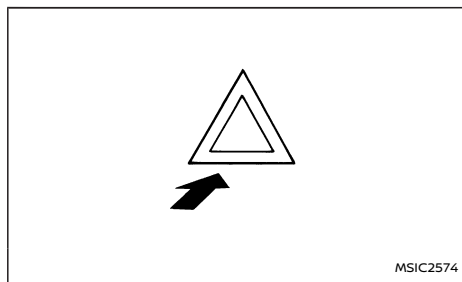
The active sound enhancement generates sounds according to engine speed and driving modes through the speakers ② and woofer ③ to enhance the quality of the engine sound.

MEMO

6 In case of emergency

Hazard warning flasher switch	402	Jump starting	407
Emergency Stop Signal	402	Push starting	409
Emergency e-POWER system shut off	403	If your vehicle overheats	409
Flat tyre	403	Towing your vehicle	410
Tyre Pressure Monitoring System (TPMS)	403	Towing recommended by NISSAN	411
Repairing flat tyre	403		

HAZARD WARNING FLASHER SWITCH



The hazard indicator flasher switch operates regardless of the power switch position except when the 12-volt battery is discharged.

The hazard indicator flasher is used to warn other drivers when you have to stop or park under emergency conditions.

When the hazard indicator flasher switch is pushed, all turn signal lights will flash. To turn off the hazard indicator flasher, push the hazard indicator flasher switch again.

When an impact that could activate the supplemental air bags is detected, the hazard warning flasher lights blink automatically.

WARNING

Do not turn the hazard warning flasher switch to off until you can make sure that it is safe to do so. Also, the hazard flasher warning may not blink automatically depending on the force of impact.

If the hazard warning flasher switch is pushed, the hazard warning flashers will turn off.

EMERGENCY STOP SIGNAL

The Emergency Stop Signal will blink the brake light and high-mounted brake light to prevent the rear-end collision, when a sudden braking operation is detected.

The Emergency Stop Signal operates in the following conditions:

- When the vehicle speed is above 60 km/h (37 MPH)
- When the system detects a sudden braking while the footbrake is applied

The Emergency Stop Signal will not operate in the following conditions:

- When the hazard indicator flasher operates
- When the system does not detect a sudden braking

EMERGENCY e-POWER SYSTEM SHUT OFF FLAT TYRE

To shut off the e-POWER system in an emergency situation while driving, perform the following procedure:

- Rapidly push the push-button power switch 3 consecutive times in less than 1.5 seconds, or
- Push and hold the push-button power switch for more than 2 seconds.

TYRE PRESSURE MONITORING SYSTEM (TPMS)

This vehicle is equipped with the Tyre Pressure Monitoring System (TPMS). It monitors tyre pressure of all tyres. When the low tyre pressure warning light is lit, and the "Low Tyre Pressure" warning message is displayed in the vehicle information display, one or more of your tyres is significantly under-inflated. If the vehicle is being driven with low tyre pressure, the TPMS will activate and warn you of it by the low tyre pressure warning light. This system will activate only when the vehicle is driven at speeds above 25 km/h (16 MPH). For more details, see "Warning lights, indicator lights and audible reminders" (P.83) and "Tyre Pressure Monitoring System (TPMS)" (P.231).

WARNING

- **If the low tyre pressure warning light illuminates while driving, avoid sudden steering manoeuvres or abrupt braking, reduce vehicle speed, pull off the road to a safe location and stop the vehicle as soon as possible. Driving with under-inflated tyres may permanently damage the tyres and increase the likelihood of tyre failure. Serious vehicle damage could occur and may lead to an accident and could result in serious personal injury. Check the tyre pressure for all four tyres. Adjust the tyre pressure to the recommended COLD tyre pressure shown on the tyre placard to turn the low tyre pressure warning light OFF. If the light still illuminates while driving after adjusting the tyre pressure, a tyre may be**

flat. If you have a flat tyre, repair it with an emergency tyre puncture repair kit as soon as possible.

- **Replacing tyres with those not originally specified by NISSAN could affect the proper operation of the TPMS.**
- **NISSAN recommends using only Genuine NISSAN Emergency Tyre Sealant provided with your vehicle. Other tyre sealants may damage the valve stem seal which can cause the tyre to lose air pressure. Visit a NISSAN dealer or qualified workshop as soon as possible after using tyre repair sealant.**

REPAIRING FLAT TYRE

The emergency tyre puncture repair kit is supplied with the vehicle instead of a spare tyre. This repair kit must be used for temporarily fixing a minor tyre puncture. After using the repair kit, see a NISSAN dealer or qualified workshop as soon as possible for tyre inspection and repair/replacement.

CAUTION

- **NISSAN recommends using only Genuine NISSAN Emergency Tyre Sealant provided with your vehicle. Other tyre sealants may damage the valve stem seal which can cause the tyre to lose air pressure.**
- **Do not use the emergency tyre puncture repair kit provided with your vehicle on other vehicles.**
- **Do not use the emergency tyre puncture repair kit for a purpose other than to**

inflate and check the tyre pressure for the vehicle.

- Use the emergency tyre puncture repair kit only on DC12V.
- Keep water and dust off the emergency tyre puncture repair kit.
- Do not disassemble or modify the emergency tyre puncture repair kit.
- Do not galvanise the emergency tyre puncture repair kit.
- Do not use the emergency tyre puncture repair kit under the following conditions. Contact a NISSAN dealer or qualified workshop or professional road assistance.

– when the sealant has passed its expiration date (shown on the label attached to the bottle)

– when the cut or the puncture is approximately 6 mm (0.25 in) or longer

– when the side of the tyre is damaged

– when the vehicle has been driven with a considerable loss of air from the tyre

– when the tyre is completely displaced inside or outside the rim

– when the tyre rim is damaged

– when two or more tyres are flat

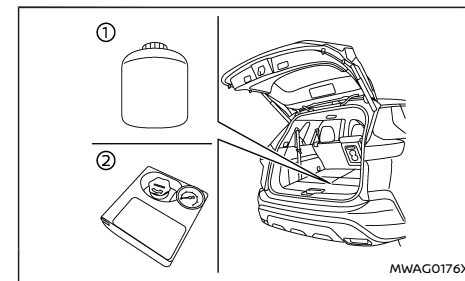
Stopping vehicle

⚠ WARNING

- **Make sure the parking brake is securely applied and the vehicle is placed into the P (Park) position.**
- **Never repair tyres when the vehicle is on a slope, ice or slippery area. This is hazardous.**
- **Never repair tyres when the oncoming traffic is close to your vehicle. Call for professional road assistance.**

1. Safely move the vehicle off the road away from traffic.
2. Turn on the hazard indicator flasher lights.
3. Park on a level surface.
4. Apply the parking brake.
5. Push the P position switch to shift to the P (Park) position.
6. Place the power switch in the OFF position.
7. Open the bonnet and set up the warning triangle (where fitted):
 - To warn other traffic.
 - To signal professional road assistance personnel that you need assistance.
8. Have all passengers get out from the vehicle and stand in a safe place, away from other traffic and clear of the vehicle.

Getting emergency tyre puncture repair kit



Example

Take out the emergency tyre puncture repair kit from the storage area under the luggage floor board. The repair kit consists of the following items:

- ① Tyre sealant bottle
- ② Air compressor*

*: The compressor shape may differ depending on the models.

Before using emergency tyre puncture repair kit

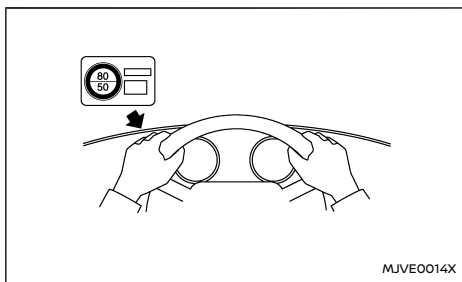
- If any foreign object (for example, a screw or nail) is embedded in the tyre, do not remove it.
- Check the expiration date of the sealant (shown on the label attached to the bottle). Never use a sealant whose expiration date has passed.

Repairing tyre

⚠ WARNING

Observe the following precautions when using the emergency tyre puncture repair kit.

- Swallowing the compound is dangerous. Immediately drink as much water as possible and seek prompt medical assistance.
- Rinse well with lots of water if the compound comes into contact with skin or eyes. If irritation persists, seek prompt medical attention.
- Keep the repair compound out of the reach of children.

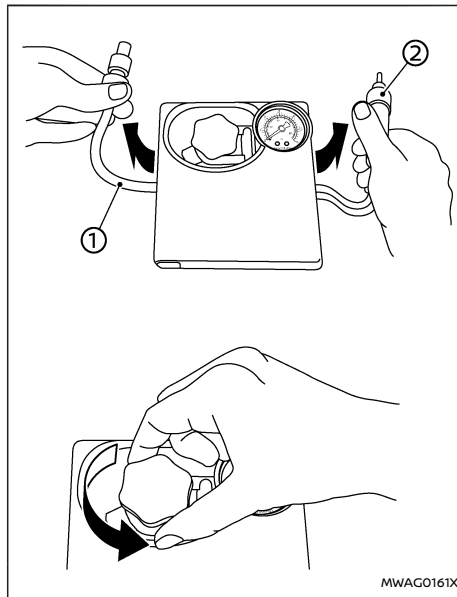


1. Take out the speed restriction sticker from the air compressor*, then put it in a location where the driver can see it while driving.

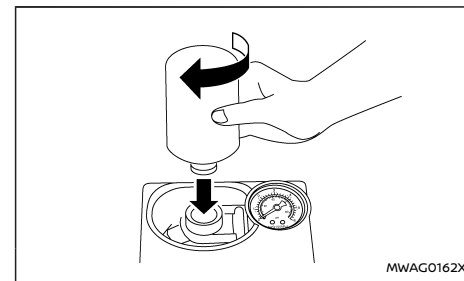
*: The compressor shape may differ depending on the models.

CAUTION

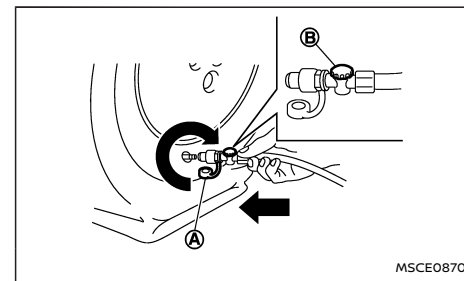
Do not put the speed restriction label on the steering wheel pad, the speedometer or the warning light locations.



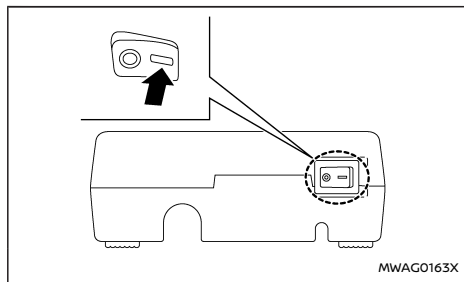
2. Take the hose ① and the power plug ② out of the air compressor. Remove the cap of the bottle holder from the air compressor.



3. Remove the cap of the tyre sealant bottle, and screw the bottle clockwise onto the bottle holder. (Leave the bottle seal intact. Screwing the bottle onto the bottle holder will pierce the seal of the bottle.)
4. Remove the cap of the tyre valve on the flat tyre.



5. Remove the protective cap (A) of the hose and screw the hose securely onto the tyre valve. Make sure that the pressure release valve (B) is securely tightened. Make sure that the air compressor switch is in the OFF (O) position, and then insert its power plug into the power outlet in the vehicle.



6. Place the power switch in the ON position. Then turn the compressor switch to the ON (-) position and inflate the tyre up to the pressure that is specified on the tyre placard affixed to the driver's side centre pillar if possible, or to the minimum of 180 kPa (26 psi). Turn the air compressor off briefly in order to check the tyre pressure with the pressure gauge.

If the tyre is inflated to higher than the specified pressure, adjust the tyre pressure by releasing air with the pressure release valve. The cold tyre pressures are shown on the tyre placard affixed to the driver's side centre pillar.

CAUTION

- An incomplete connection between the hose and tyre valve causes air leakage or sealant scatter.
- Do not stand directly beside the damaged tyre while it is being inflated because of the risk of the rupture. If there are any cracks or bumps, turn the compressor off immediately.
- There is a possibility that the pressure reaches 600 kPa (87 psi) while the tyre is being inflated, but it is normal condition. Usually the pressure will drop in about 30 seconds.
- Do not operate the compressor for more than 10 minutes.

If the tyre pressure does not increase to **180 kPa (26 psi) within 10 minutes**, the tyre may be seriously damaged and **the tyre cannot be repaired with this tyre puncture repair kit**. Contact a NISSAN dealer or qualified workshop.

7. When the tyre pressure is reaching the specified pressure or is at the minimum of 180 kPa (26 psi), turn the air compressor off. Remove the power plug from the power outlet and quickly remove the hose from the tyre valve. Attach the protective cap and valve cap.

CAUTION

Leave the tyre sealant bottle on the bottle holder in order to prevent sealant from spilling out.

8. Immediately drive the vehicle for 10 minutes or 3 km (2 miles) at a speed of 80 km/h (50 MPH) or less.
9. After driving, make sure that the air compressor switch is in the OFF (O) position, then screw the hose securely onto the tyre valve. Check the tyre pressure with the pressure gauge.

If the tyre pressure drops under 130 kPa (19 psi): The tyre cannot be repaired with this tyre puncture repair kit. Contact a NISSAN dealer or qualified workshop.

If the tyre pressure is 130 kPa (19 psi) or more but less than the specified pressure:

Turn the compressor switch to the ON (-) position and inflate the tyre up to the specified pressure. Then repeat the steps from 8.

If the pressure drops again, **the tyre cannot be repaired with this tyre puncture repair kit.** Contact a NISSAN dealer or qualified workshop.

When the tyre pressure is the specified pressure:

The temporary repair is completed.

See a NISSAN dealer or qualified workshop for tyre repair/replacement as soon as possible.

JUMP STARTING

CAUTION

Do not reuse the tyre sealant bottle or the hose.

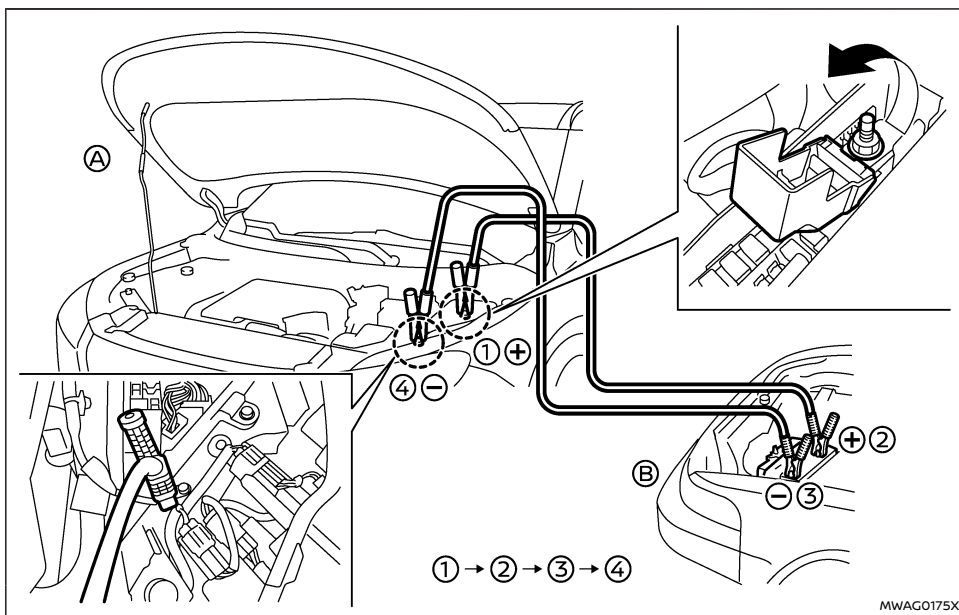
For a new tyre sealant bottle and hose, see a NISSAN dealer or qualified workshop.

After repairing tyre

See a NISSAN dealer or qualified workshop for tyre repair/replacement as soon as possible.

⚠ WARNING

- Incorrect jump starting can lead to a 12-volt battery explosion. The 12-volt battery explosion may result in severe injury or death. It may also result in damage to the vehicle. Be sure to follow the instructions in this section.
- Explosive hydrogen gas is always present in the vicinity of the 12-volt battery. Keep all sparks and flames away from the 12-volt battery.
- Always wear suitable eye protection and remove rings, bracelets, and any other jewellery whenever working on or near a 12-volt battery.
- Never lean over the 12-volt battery while jump starting.
- Never allow 12-volt battery fluid to come into contact with eyes, skin, clothes or the vehicle's painted surfaces. 12-volt battery fluid is a corrosive sulphuric acid which can cause severe burns. If the fluid comes into contact with anything, immediately flush the contacted area with plenty of water.
- Keep the 12-volt battery out of the reach of children.
- The booster 12-volt battery must be rated at 12 volts. Use of an incorrectly rated 12-volt battery will damage your vehicle.
- Never attempt to jump start a frozen 12-volt battery. It could explode and cause serious injury.



1. If the booster 12-volt battery is in another vehicle **(B)**, position the two vehicles **(A)** and **(B)** to bring the batteries into close proximity to each other.
2. Apply the parking brake.
3. Push the P position switch to engage the P (Park) position.
4. Switch off all unnecessary electrical systems (headlights, heater, air conditioner, etc.).
5. Place the power switch in the OFF position.
6. Remove the fuse box cover by pushing the tabs.

NOTE:

The point **①** is located inside the fuse box.

7. Open the inner cover.
8. Connect the jumper cables in the sequence as illustrated (**①**, **②**, **③**, **④**).

CAUTION

- Always connect positive \oplus to positive \oplus and negative \ominus to body ground, NOT to the 12-volt battery's negative \ominus .
- Be sure that the jumper cables do not touch moving parts in the engine compartment.
- Be sure that the jumper cable's clamps do not contact any other metal.

9. Start the engine of the booster vehicle **(B)** and let it run for a few minutes.
10. Start the e-POWER system of the jumped vehicle **(A)** in the normal manner.

If the e-POWER system cannot be started, stop the engine of the booster vehicle and place the power switch in the OFF position. Then, once open and close the driver's side door, and keeping the door closed, wait for more than 3 minutes without any other operations (navigation, audio, door lock, etc.). After that, repeat the steps from 9.

11. After the e-POWER system is started, carefully disconnect the jumper cables in the opposite sequence from that illustrated (**④**, **③**, **②**, **①**).
12. Close the inner cover and replace the fuse box cover.

PUSH STARTING

NOTE:

- Do not use this vehicle as a booster vehicle.
- If the 12-volt battery is discharged, the power switch cannot be placed in the ON or OFF position. Charge the 12-volt battery immediately.

Do not attempt to start the engine by pushing the vehicle.

CAUTION

- The e-POWER models cannot be push-started or tow-started. Attempting to do so may cause electric motor damage.
- Three-way catalyst equipped models should not be started by pushing since the three way catalyst may be damaged.
- Never try to start the engine by towing. When the engine starts, the forward surge could cause the vehicle to collide with the towing vehicle.

IF YOUR VEHICLE OVERHEATS

WARNING

- Never continue driving if your vehicle overheats. Doing so could cause a vehicle fire.
- Never open the bonnet if steam is coming out.
- Never remove the radiator or coolant reservoir cap while the engine is hot. If the radiator or coolant reservoir cap is removed when the engine is hot, pressurised hot water will spurt out and possibly cause burning, scalding or serious injury.
- If steam or coolant is coming from the engine, stand clear of the vehicle to prevent getting burned.
- The engine cooling fan will start at anytime when the coolant temperature exceeds preset degrees.
- Be careful not to allow your hands, hair, jewellery or clothing to come into contact with, or to get caught in the cooling fan or drive belts.

If your vehicle is overheating (indicated by an extremely high temperature gauge reading), or if you feel a lack of traction motor power, detect abnormal noise, etc., take the following steps:

1. Move the vehicle safely off the road and apply the parking brake.
2. Push the P position switch to shift to the P (Park) position.

Do not stop the e-POWER system.

TOWING YOUR VEHICLE

- Turn off the air conditioner. Open all the windows, move the heater or air conditioner temperature control to maximum hot and fan control to high speed.
- Get out of the vehicle. Look and listen for steam or coolant escaping from the radiator or coolant reservoir before opening the bonnet. (If steam or coolant is escaping, turn off the e-POWER system.) Do not open the bonnet further until no steam or coolant can be seen.
- Open the engine bonnet.

WARNING

If steam or water is coming from the traction motor, stand clear to prevent getting burned.

- Visually check the drive belt for damage or looseness. Also check if the cooling fan is running. The radiator hoses and radiator should not leak water. If coolant is leaking or the cooling fan does not run, stop the e-POWER system.

WARNING

Be careful not to allow your hands, hair, jewellery or clothing to come into contact with, or get caught in, engine belts or the engine cooling fan. The engine cooling fan can start at any time.

- After the engine cools down, check the coolant level in the reservoir with the engine running. Add coolant to the reservoir if necessary. Have your vehicle repaired by a NISSAN dealer or qualified workshop or qualified workshop.

When towing your vehicle, local regulations for towing must be followed. Incorrect towing equipment could damage your vehicle. To assure proper towing and to prevent accidental damage to your vehicle, NISSAN recommends that you have professional road assistance personnel tow your vehicle. It is advisable to have the professional road assistant carefully read the following precautions.

WARNING

- Never ride in a vehicle that is being towed.
- Never get under your vehicle after it has been lifted by a tow truck.
- Do not use the e-Pedal Step system when your vehicle is towed.

CAUTION

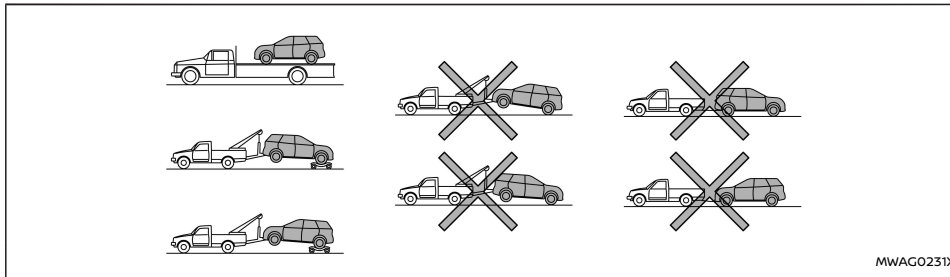
- When towing, make sure that the transmission, axles, steering system and powertrain are in working condition. If any of these conditions apply, dollies or a flatbed tow truck must be used.
- Always attach safety chains before towing.

NOTE:

If the 12-volt battery is completely drained, the transmission will not manually shift to other positions. For shifting to other positions, charge the 12-volt battery or supply power following the jump starting procedure. Push the P position switch to shift to the P (Park) position before shifting to other positions.

TOWING RECOMMENDED BY NISSAN

Four-Wheel Drive (4WD) models

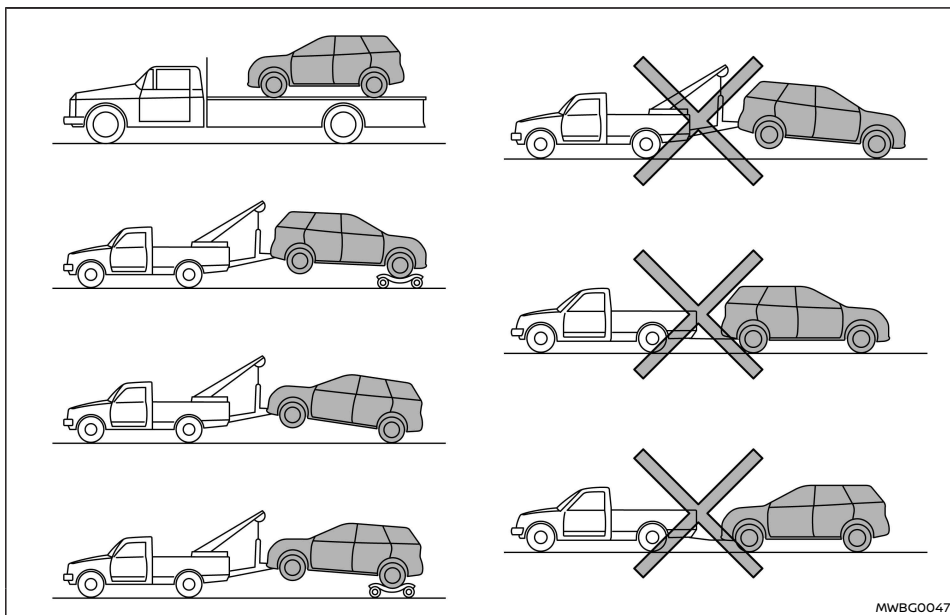


NISSAN recommends that towing dollies be used when towing your vehicle or the vehicle be placed on a flat bed truck as illustrated.

CAUTION

Never tow Four-Wheel Drive (4WD) models with any of the wheels on the ground as this may cause serious and expensive damage to the transfer case and transmission.

Two-Wheel Drive (2WD) models



MWBG0047X

NISSAN recommends that your vehicle be towed with the driving (front) wheels off the ground or place the vehicle on a flat bed truck as illustrated.

NOTE:

If the electronic parking brake is released, the rear wheels can be grounded while towing. If the electronic parking brake is not released, towing dollies should be used. For additional information, refer to "Parking brake" (P.189).

CAUTION

Never tow e-POWER models with the front wheels on the ground or four wheels on the ground (forward or backward), as this may cause serious and expensive damage to the transmission. If it is necessary to tow the vehicle with the rear wheels raised, always use towing dollies under the front wheels.

Freeing trapped vehicle

⚠ WARNING

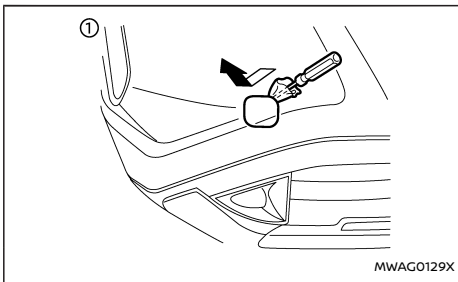
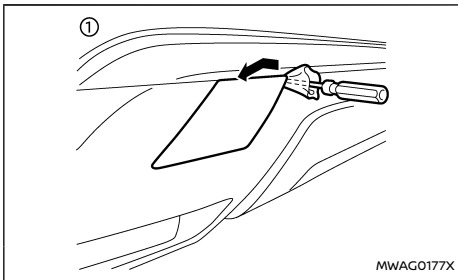
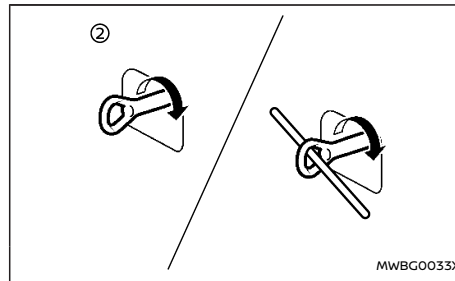
- Never allow anyone to stand near the towing line during the pulling operation.
- Never spin the tyres at high speed. This could cause them to explode and result in serious injury. Parts of the vehicle could also overheat and be damaged.

In the event that your vehicle's tyres become trapped in sand, snow, or mud, and the vehicle is unable to free itself without being pulled, use the recovery hook.

- Use the recovery hook only. Do not attach the pulling device to any other part of the vehicle body. Otherwise, the vehicle body may be damaged.
- Use the recovery hook to free a vehicle only.
- The recovery hook is under tremendous stress when used to free a trapped vehicle. Always pull the pulling device straight out from the vehicle. Never pull on the recovery hook at an angle.

CAUTION

There are two hooks in the storage area. Use the longer hook for front, and shorter hook for rear. If the different hook is used, the vehicle and the hook may be damaged.

**Front****Rear**

- ① Remove the hook cover from the bumper with a suitable tool.
- ② Securely install the recovery hook as illustrated. (The hook is stored in the storage area under the luggage board.)

Make sure that the recovery hook is properly secured in its storage area after use.

MEMO

7 Appearance and care

Cleaning exterior	416	Cleaning interior	418
Washing	416	Air fresheners	418
Badges, Stripes or Graphics (where fitted)	417	Floor mats	419
Removing spots	417	Glass	419
Waxing	417	Seat belts	419
Glass	417	Corrosion protection	420
Underbody	417	Most common factors contributing to vehicle corrosion	420
Wheels	417	Environmental factors influence rate of corrosion	420
Aluminium alloy wheels	417	To protect your vehicle from corrosion	420
Chrome parts	418		

CLEANING EXTERIOR

In order to maintain the appearance of your vehicle, it is important to take proper care of it.

Whenever possible, park your vehicle inside a garage or in a covered area to minimise the chances of damaging the paint surface of your vehicle.

When it is necessary to park outside, park in a shady area or protect the vehicle with a body cover. **Be careful not to scratch the paint surface when putting on or removing the body cover.**

WASHING

In the following instances, wash your vehicle as soon as possible to protect the paint surface:

- After a rainfall, which may cause the paint surface damage from acid rain.
 - After driving on coastal roads, which may cause rusting from the sea breeze.
 - When contaminants such as soot, bird droppings, tree sap, metal particles or bugs get on the paint surface.
 - When dust or mud builds up on the paint surface.
1. Wash the vehicle surface with a wet sponge and plenty of water.
 2. Clean the vehicle surface gently and thoroughly using a mild soap, a special vehicle soap or a general purpose dishwashing liquid mixed with clean, lukewarm (never hot) water.

CAUTION

- **Do not concentrate water spray directly on the parking sensors (sonar) on the bumper as this will result in damage to the sensors.**
- **Do not use pressure washers capable of spraying water over 8,274 kPa (1,200 psi) to wash your vehicle. Use of high-pressure washers over 8,274 kPa (1,200 psi) can result in damage to or removal of paint or graphics. Avoid using a highpressure washer closer than 30 cm (12 in) to the vehicle. Always use a wide-angle nozzle only, keep the nozzle moving and do not concentrate the water spray on any one area.**
- **Do not wash the engine compartment with water or by directly spraying wax, car polish, engine degreaser, etc. Doing so may cause a failure in e-POWER system starting or a malfunction, or a short circuit in the electrical parts. When using water or these products, apply them to a cloth and then wipe the engine compartment with it.**
- **Do not wash the vehicle with strong household soap, strong chemical detergents, petrol or solvents.**
- **Do not wash the vehicle in direct sunlight or while the vehicle body is hot, as the paint surface may become water-spotted.**
- **Avoid using tight-napped or rough cloths, such as washing mitts. Care must be taken when removing caked-on dirt or other**

foreign substances so the paint surface is not scratched or damaged.

- **Before washing the vehicle by an automatic car wash, make sure that the fuel-filler lid is completely closed.**
- **Do not wash the engine compartment. Doing so may cause a failure in e-POWER system starting or a malfunction. If water is sprinkled to the electrical parts, it may result in a short circuit and could cause a fire.**

3. Rinse the vehicle thoroughly with plenty of clean water.
4. Use a dampened chamois to dry the paint surface and avoid leaving water spots.

When washing the vehicle, take care of the following:

- Inside flanges, joints and folds on the doors, hatches and bonnet are particularly vulnerable to the effects of road salt. Therefore, these areas must be cleaned regularly.
- Be sure that the drain holes in the lower edge of the doors are not clogged.
- Spray water to the underbody and in the wheel wells to loosen the dirt and/or wash away road salt.

BADGES, STRIPES OR GRAPHICS (where fitted)

To maintain the premium finish of stickers, stripes and graphics on your vehicle, please observe the following care points:

- Only hand wash the surface, using PH neutral detergents.
- Do not use an automated car wash.
- Do not use chemical agents (abrasive products, polishes, petrol, wax, protective products, corrosive solvents, etc).
- Wash your vehicle as soon as you can if any insects, bird droppings, soot or metallic particles appear on the paint surface.
- The finish may deteriorate if it is marked by road oil (tar, etc.). Wash any dirt off the vehicle with a wet microfibre cloth and plenty of clean water.
- Avoid parking your vehicle under trees and remove any tree sap as soon as possible.
- Gently wash stickers using a clean sponge. Do not use a pressure washer.

REMOVING SPOTS

Remove tar and oil spots, industrial dust, insects, and tree sap as quickly as possible from the paint surface to avoid lasting damage or staining. Special cleaning products are available at a NISSAN dealer or qualified workshop or any automotive accessory store.

WAXING

Regular waxing protects the paint surface and helps maintain a new vehicle appearance.

After waxing, polishing is recommended to remove built-up residue and to avoid a weathered appearance.

A NISSAN dealer or qualified workshop can assist you in choosing the appropriate waxing products.

CAUTION

- **Wash your vehicle thoroughly and completely before applying wax to the paint surface.**
- **Always follow the manufacturer's instructions supplied with the wax.**
- **Do not use a wax containing any abrasives, cutting compounds or cleaners that may damage the vehicle finish.**

Machine compounding or aggressive polishing on a base coat/clear coat paint finish may dull the finish or leave swirl marks.

GLASS

Use glass cleaner to remove smoke and dust film from the glass surfaces. It is normal for glass to become coated with a film after the vehicle is parked in the hot sun. Glass cleaner and a soft cloth will easily remove this film.

UNDERBODY

In areas where road salt is used in the winter, it is necessary to clean the vehicle's underbody regularly in order to prevent dirt and salt from building up and causing the acceleration of corrosion on the underbody and suspension.

Before the winter and again in the spring, the underseal must be checked and, if necessary, re-treated.

WHEELS

- Wash the wheels when washing the vehicle to maintain their appearance.
- Clean the inner side of the wheels when the wheel is changed or the underside of the vehicle is washed.
- Do not use abrasive cleaners when washing the wheels.
- Inspect wheel rims regularly for dents or corrosion. This may cause loss of pressure or damage the tyre bead.
- NISSAN recommends that the road wheels be waxed to protect against road salt in areas where it is used during winter.

ALUMINIUM ALLOY WHEELS

Wash the wheels regularly with a sponge dampened in a mild soap solution, especially during winter in areas where road salt is used. The salt residue from road salt could discolor the wheels if it is not washed off regularly.

CLEANING INTERIOR

CAUTION

Follow the directions below to avoid staining or discoloring the wheels:

- Do not use a cleaner that uses strong acid or alkali contents to clean the wheels.
- Do not apply wheel cleaners to the wheels when they are hot. The wheel temperature should be the same as ambient temperature.
- Rinse the wheel to completely remove the cleaner within 15 minutes after the cleaner is applied.

CHROME PARTS

Clean all chrome parts regularly with a nonabrasive chrome polish to maintain the finish.

Occasionally remove loose dust from the interior trim, plastic parts and seats using a vacuum cleaner or soft bristled brush. Wipe the vinyl and leather surfaces with a clean, soft cloth dampened in mild soap solution, then wipe clean with a dry, soft cloth.

Regular care and cleaning is required in order to maintain the appearance of the leather.

Before using any fabric protector, read the manufacturer's recommendations. Some fabric protectors contain chemicals that may stain or bleach the seat material.

Use a soft cloth dampened only with water to clean the meter and gauge lens covers.

WARNING

Do not use water or acidic cleaners (hot steam cleaners) on the seat. This can damage the seat or occupant classification sensors. This can also affect the operation of the air bag system and result in serious personal injury.

CAUTION

- Never use benzene, thinner or any similar material.
- Small dirt particles can be abrasive and damaging to leather surfaces and should be removed promptly. Do not use saddle soap, car waxes, polishes, oils, cleaning fluids, solvents, detergents or ammonia-based cleaners as they damage the leather natural finish.
- Never use fabric protectors unless recommended by the manufacturer.

- Do not use glass or plastic cleaner on meter or gauge lens covers. It may damage the lens covers.
- Do not spill on or make contact with interior surfaces while handling air fresheners, aroma agents, cosmetics, sunscreen, etc. They may cause permanent discoloration, stain, crack, paint peeling, etc. depending on the ingredients. If they contact the interior surface, wipe them off immediately using a soft cloth.
- Do not use the chlorine-based cleaning liquid such as chlorine dioxide and hypochlorous acid, which may cause the paint peeling, corrosion, etc. If it is unavoidable to clean or sterilize interior surfaces, use less than 75% ethanol. Wipe the interior parts with a dry cloth dampened with ethanol. Wipe off ethanol completely. If you leave it uncleaned, it may cause paint peeling, discoloration, etc. Since ethanol is flammable, be careful of fire.

AIR FRESHENERS

Most air fresheners use a solvent that could affect the vehicle interior. If you use an air freshener, take the following precautions:

- Hanging-type air fresheners can cause permanent discoloration when they contact vehicle interior surfaces. Place the air freshener in a location that allows it to hang free and not contact an interior surface.

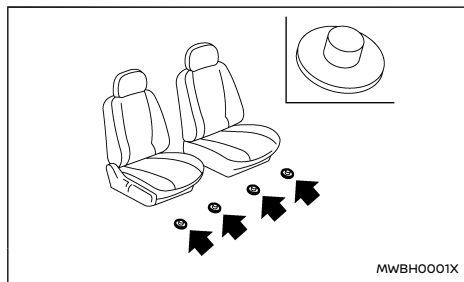
- Liquid-type air fresheners typically clip on the vents. These products can cause immediate damage and discoloration when spilled on interior surfaces.

Carefully read and follow the manufacturer's instructions before using air fresheners.

FLOOR MATS

The use of Genuine NISSAN floor mats (where fitted) can extend the life of your vehicle carpet and make it easier to clean the interior. Regardless of what mats are used, be sure they are fitted for your vehicle and are properly positioned in the foot well to prevent interference with pedal operation. Mats should be maintained with regular cleaning and replaced if they become excessively worn.

Floor mat positioning aid



This vehicle includes front floor mat brackets to act as a floor mat positioning aid. Genuine NISSAN floor mats have been specially designed for your vehicle model.

Position the mat by placing the floor mat bracket hook(s) through the floor mat grommet hole while centering the mat in the foot area.

Push the grommet hole into the hook firmly and secure it.

Periodically check that the mats are properly positioned.

GLASS

Use glass cleaner to remove smoke and dust film from the glass surfaces. It is normal for glass to become coated with a film after the vehicle is parked in the hot sun. Glass cleaner and a soft cloth will easily remove this film.

CAUTION

When cleaning the inside of the windows, do not use sharp-edged tools, abrasive cleaners or chlorine-based disinfectant cleaners. They could damage the electrical conductors, such as rear window defogger elements.

SEAT BELTS

⚠ WARNING

- Do not allow wet seat belts to roll up in the retractor.
- Never use bleach, dye or chemical solvents to clean the seat belts, since these materials may severely weaken the seat belt webbing.

The seat belts can be cleaned by wiping them with a sponge dampened in a mild soap solution.

Allow the belts to dry completely in the shade before using them. (See "Seat belts" (P.38).)

CORROSION PROTECTION

MOST COMMON FACTORS CONTRIBUTING TO VEHICLE CORROSION

- The accumulation of moisture-retaining dirt and debris in body panel sections, cavities, and other areas.
- Damage to the paint surface and other protective coatings caused by gravel and stone chips or minor traffic accidents.

ENVIRONMENTAL FACTORS INFLUENCE RATE OF CORROSION

Moisture

The accumulation of sand, dirt and water on the inside floor of the vehicle can accelerate corrosion. Wet floor carpet/floor mats will not dry completely inside the vehicle. They should be removed and completely dried to avoid floor panel corrosion.

Relative humidity

Corrosion will be accelerated in areas of high relative humidity.

Temperature

High temperatures accelerate the rate of corrosion to those parts which are not well ventilated.

Corrosion will also be accelerated in areas where the temperatures stay above freezing.

Air pollution

Industrial pollution, the presence of salt in the air in coastal areas, or heavy road salt use accelerates the corrosion process. Road salt also accelerates the disintegration of paint surfaces.

TO PROTECT YOUR VEHICLE FROM CORROSION

- Wash and wax your vehicle often to keep the vehicle clean.
- Always check for minor damage to the paint surface and if any exists, repair it as soon as possible.
- Keep the drain holes in the lower edge of the doors open to avoid water accumulation.
- Check the vehicle underbody for accumulation of sand, dirt or salt. If present, wash with water as soon as possible.

CAUTION

- **Never remove dirt, sand or other debris from the passenger compartment by washing it out with a hose. Remove dirt with a vacuum cleaner or broom.**
- **Never allow water or other liquids to come in contact with electronic components inside the vehicle as this may damage them.**

Chemicals used for road surface deicing are extremely corrosive. They accelerate corrosion and deterioration of underbody components such as the exhaust system, fuel and brake lines, brake cables, floor pan and fenders.

In the winter, the underbody must be cleaned periodically.

For additional protection against rust and corrosion, which may be required in some areas, consult a NISSAN dealer or qualified workshop.

8 Maintenance and do-it-yourself

Maintenance requirements	423	Brake fluid	434
General maintenance	423	Gear fluid	434
Scheduled maintenance	423	Air cleaner	435
Where to go for service	423	Wiper blades	436
General maintenance	423	Windscreen wiper blades	436
Explanation of general maintenance items	423	Rear window wiper blade	436
Maintenance precautions	425	Window washer fluid	437
Engine compartment check locations	427	12-volt battery	437
KR15DDT engine model	427	Vehicle 12-volt battery	437
Engine cooling system	428	Intelligent Key battery	439
Checking engine coolant level	428	Variable voltage control system	440
Changing engine coolant	428	Fuses	440
Inverter cooling system	429	Engine compartment	440
Checking inverter coolant level	429	Passenger compartment	441
Changing inverter coolant	429	Lights	443
Engine oil	430	Headlights	444
Checking engine oil level	430	Exterior and interior lights	444
Changing engine oil and filter	430	Legal requirement to adjust headlight beam	445
Drive belt	432	Tyres and Wheels	447
Spark plugs	432	Tyre Pressure Monitoring System (TPMS)	447
Replacing spark plugs	432	Tyre inflation pressure	447
Brakes	433	Types of tyres	447
Checking parking brake	433	Tyre chains	447
Checking footbrake	433	Tyre rotation	448
		Tyre wear and damage	448

Tyre age	448
Changing tyres and wheels	449
Wheel balance	449
Jacking up vehicle and replacing tyres	449
Emergency tyre puncture repair kit	453

MAINTENANCE REQUIREMENTS

Some day-to-day and regular maintenance is essential to maintain your vehicle's good mechanical condition, as well as its emission and engine performance.

It is the owner's responsibility to make sure that the specified maintenance, as well as general maintenance, is performed.

As the vehicle owner, you are the only one who can ensure that your vehicle receives the proper maintenance care.

GENERAL MAINTENANCE

General maintenance includes those items which should be checked during normal day-to-day operation of the vehicle. They are essential if your vehicle is to continue to operate properly. It is your responsibility to perform these procedures regularly as prescribed.

Performing general maintenance checks requires minimal mechanical skill and only a few general automotive tools.

These checks and inspections can be done by yourself, a qualified technician, or if you prefer, a NISSAN dealer or qualified workshop.

SCHEDULED MAINTENANCE

For your convenience, the required scheduled maintenance items are described and listed in a separate Warranty Information and Maintenance booklet. You must refer to that booklet to ensure that necessary maintenance is performed on your vehicle at regular intervals.

WHERE TO GO FOR SERVICE

If maintenance service is required or your vehicle appears to malfunction, have the systems checked and tuned by an authorised NISSAN dealer or qualified workshop.

GENERAL MAINTENANCE

During normal day-to-day operation of the vehicle, general maintenance should be performed regularly as prescribed in this section. If you detect any unusual sounds, vibrations or smells, be sure to check for the cause or have a NISSAN dealer or qualified workshop do it promptly. In addition, you should notify a NISSAN dealer or qualified workshop if you think that repairs are required.

When performing any checks or maintenance work, closely observe "Maintenance precautions" (P.425).

EXPLANATION OF GENERAL MAINTENANCE ITEMS

Additional information on the following items with "*" is found later in this section.

Outside vehicle

The maintenance items listed here should be performed from time to time, unless otherwise specified.

Doors and bonnet:

Check that all doors and the bonnet operate smoothly as well as the back door, boot lid and hatch. Also make sure that all latches lock securely. Lubricate if necessary. Make sure that the secondary latch keeps the bonnet from opening when the primary latch is released. When driving in areas using road salt or other corrosive materials, check lubrication frequently.

Lights*:

Clean the headlights on a regular basis. Make sure that the headlights, brake lights, tail lights, turn signal lights, and other lights are all operating

properly and installed securely. Also check the aim of the headlights.

Tyres*:

Check the pressure with a gauge often and always prior to long distance trips. Adjust the pressure in all tyres, including the spare, to the pressure specified.

Check carefully for damage, cuts or excessive wear.

Tyre rotation*:

In the case that Two-Wheel Drive (2WD) and front and rear tyres are same size; tyres should be rotated every 10,000 km (6,000 miles). Tyres marked with directional indicators can only be rotated between front and rear. Make sure that the directional indicators point in the direction of wheel rotation after the tyre rotation is completed.

In the case that Four-Wheel Drive and All Wheel Drive (4WD/AWD) and front and rear tyres are same size; tyres should be rotated every 5,000 km (3,000 miles). Tyres marked with directional indicators can only be rotated between front and rear. Make sure that the directional indicators point in the direction of wheel rotation after the tyre rotation is completed.

In the case that front tyres are different size from rear tyres; tyres cannot be rotated.

The timing for tyre rotation may vary according to your driving habits and the road surface conditions.

Tyre Pressure Monitoring System (TPMS) tyre pressure sensor (where fitted):

It is recommended that you replace the TPMS tyre pressure sensor assembly when the tyres are replaced due to wear or age.

Wheel alignment and balance:

If the vehicle should pull to either side while driving on a straight and level road, or if you detect uneven or abnormal tyre wear, there may be a need for wheel alignment. If the steering wheel or seat vibrates at normal highway speeds, wheel balancing may be needed.

Windscreen:

Clean the windscreen on a regular basis. Check the windscreen at least every six months for cracks or other damage. Repair as necessary.

Wiper blades*:

Check for cracks or wear if not functioning correctly. Replace as necessary.

Inside vehicle

The maintenance items listed here should be checked on a regular basis, such as when performing periodic maintenance, cleaning the vehicle, etc.

Accelerator pedal:

Check the pedal for smooth operation and make sure that the pedal does not catch or require uneven effort. Keep the floor mats away from the pedal.

Brake pedal*:

Check the pedal for smooth operation and make sure that it is the proper distance from the floor

mat when depressed fully. Check the brake booster function. Be sure to keep the floor mats away from the pedal.

Parking brake*:

Check the parking brake operation regularly. The vehicle should be securely held on a fairly steep hill with only the parking brake applied. If the parking brake needs adjusted, it is recommended you visit a NISSAN dealer or qualified workshop for this service.

Seat belts:

Check that all parts of the seat belt system (for example, buckles, anchors, adjusters and retractors) operate properly and smoothly, and are installed securely. Check the belt webbing for cuts, fraying, wear or damage.

Steering wheel:

Check for changes in the steering condition, such as excessive play, hard steering or strange noises.

Warning lights and chimes:

Make sure that all warning lights and chimes are operating properly.

Windscreen defogger:

Check that the air comes out of the defogger outlets properly and in good quantity when operating the heater or air conditioner.

Windscreen wiper and washer*:

Check that the wipers and washer operate properly and that the wipers do not streak.

Under bonnet and vehicle

The maintenance items listed here should be checked periodically (for example, each time you check the engine oil or refuel).

12-volt battery (except for maintenance free batteries)*:

Check the fluid level in each cell. It should be between the UPPER and LOWER lines. Vehicles operated in high temperatures or under severe conditions require frequent checks of the battery fluid level.

Brake (and clutch) fluid level(s)*:

For Manual Transmission (MT) model; make sure that the brake and clutch fluid levels are between the MAX and MIN lines on the reservoirs.

Except for Manual Transmission (MT) model; make sure that the brake fluid level is between the MAX and MIN lines on the reservoir.

Engine coolant level*:

Check the coolant level when the engine is cold. Make sure that the coolant level is between the MAX and MIN lines on the reservoir.

Inverter coolant level*:

Check the coolant level when the engine is cold. Make sure that the coolant level is between the MAX and MIN lines on the reservoir.

Engine drive belt(s)*:

Make sure that drive belt(s) is not frayed, worn, cracked or oily.

Engine oil level*:

Check the level after parking the vehicle (on a level ground) and turning off the engine.

Fluid leaks:

Check under the vehicle for fuel, oil, water or other fluid leaks after the vehicle has been parked for a while. Water dripping from the air conditioner after use is normal. If you should notice any leaks or if fuel fumes are evident, check for cause and have it corrected immediately.

Window washer fluid*:

Check that there is adequate fluid in the reservoir.

MAINTENANCE PRECAUTIONS

When performing any inspection or maintenance work on your vehicle, always take care to prevent serious accidental injury to yourself or damage to the vehicle. The following are general precautions which should be closely observed.

WARNING

- Never touch, disassemble, remove or replace the high voltage parts, harnesses and their connectors. High voltage harnesses are orange. Touching, disassembling, removing or replacing those parts and harnesses can cause severe burns or electric shock that may result in serious injury or death.
 - Never try to remove the service plug located under the console box. The service plug is used only when the vehicle is serviced by trained technicians wearing personal protection equipment and is part
- of the high voltage system. Touching the service plug can cause severe burns or electric shock that may result in serious injury or death.
- The e-POWER system uses high voltage up to approximately 420 volts. The system can be hot while and after starting. Be careful of both the high voltage and the high temperature. Obey the caution labels attached to the vehicle.
 - The engine can start at any time without warning when the e-POWER system is in the READY to drive mode. If you must work with the e-POWER system in the READY to drive mode, keep your hands, clothing, hair and tools away from moving fans, belts and any other moving parts.
 - Park the vehicle on a level surface, apply the parking brake securely and block the wheels to prevent the vehicle from moving. Push the P position switch to shift to the P (Park) position.
 - Be sure the power switch is in the OFF position when performing any parts replacement or repairs.
 - If you must work with the engine running, keep your hands, clothing, hair and tools away from moving fans, belts and any other moving parts.
 - It is advisable to secure or remove any loose clothing and remove any jewellery, such as rings, watches, etc. before working on your vehicle.

- Always wear eye protection whenever you work on your vehicle.
- If you must run the engine in an enclosed space such as a garage, be sure there is proper ventilation for exhaust gases to escape.
- Never get under the vehicle while it is supported only by a jack. If it is necessary to work under the vehicle, support it with safety stands.
- Keep smoking materials, flame and sparks away from fuel and the battery.
- On petrol engine models with the Multiport Fuel Injection (MFI) system, the fuel filter and fuel lines should be serviced by a NISSAN dealer or qualified workshop because the fuel lines are under high pressure even when the e-POWER system is turned off.
- Your vehicle is equipped with an automatic engine cooling fan. It may come on at any time without warning, even if the power switch is in the OFF position and the e-POWER system is not running. To avoid injury, always disconnect the negative battery cable before working near the fan.

CAUTION

- Do not work under the bonnet while the engine is hot. Turn the e-POWER system off and wait until it cools down.
- Avoid direct contact with used engine oil and coolant. Improperly disposed engine

oil, and engine coolant and/or other vehicle fluids can damage the environment. Always conform to local regulations for disposal of vehicle fluid.

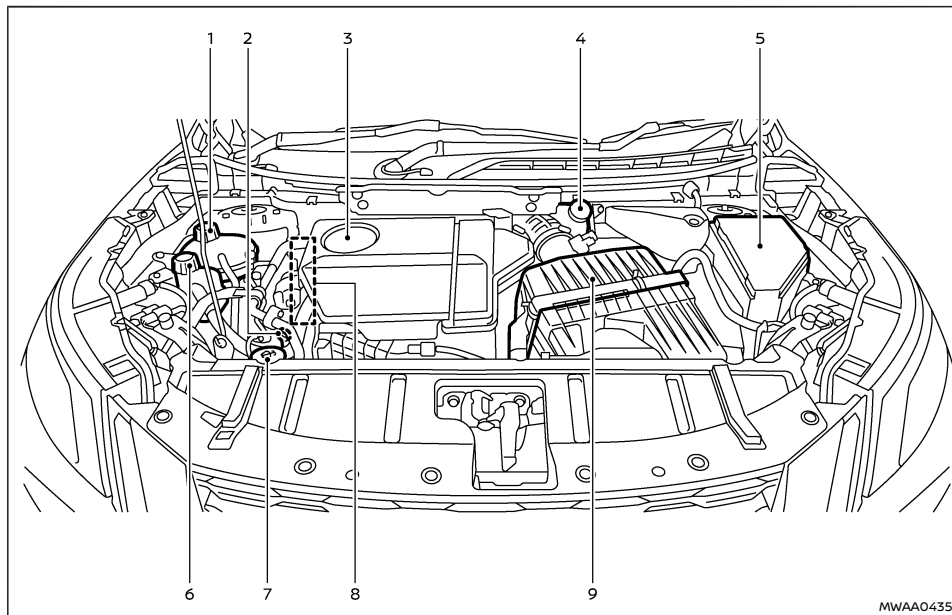
- Never leave the e-POWER system or transmission related component harness connector disconnected while the power switch is in the ON position.
- Never connect or disconnect the battery or any transistorised component while the power switch is in the ON position.

This “8. Maintenance and do-it-yourself” section gives instructions regarding only those items which are relatively easy for an owner to perform.

You should be aware that incomplete or improper servicing may result in operating difficulties or excessive emissions, and could affect your warranty coverage. **If in doubt about any servicing, have it done by a NISSAN dealer or qualified workshop.**

ENGINE COMPARTMENT CHECK LOCATIONS

KR15DDT ENGINE MODEL



MWA0435X

- | | |
|-----------------------------|----------------------------------|
| 1. Engine coolant reservoir | 5. Fuse/fusible link box |
| 2. Engine oil dipstick | 6. Inverter coolant reservoir |
| 3. Engine oil filler cap | 7. Window washer fluid reservoir |
| 4. Brake fluid reservoir* | 8. Drive belt |

9. Air cleaner

*: The layout illustrated is for the Left-Hand Drive (LHD) models. On the Right-Hand Drive (RHD) models, the brake fluid reservoir is located on the opposite side.

NOTE:

Your vehicle may not be equipped with an engine cover.

ENGINE COOLING SYSTEM

⚠ WARNING

- Never remove the radiator or the engine coolant reservoir cap when the engine is hot. Serious burns could be caused by high-pressure fluid escaping from the radiator. Wait until the engine and radiator cool down.
- Engine coolant is poisonous and should be stored carefully in marked containers out of the reach of children.

The engine cooling system is filled at the factory with a high-quality, year-round, anti-freeze coolant solution. The anti-freeze solution contains rust and corrosion inhibitors, therefore additional cooling system additives are not necessary.

CAUTION

- Never use any cooling system additives such as radiator sealer. Additives may clog the cooling system and cause damage to the engine, transmission and/or cooling system.
- When adding or replacing coolant, be sure to use only Genuine NISSAN Engine Coolant or equivalent in its quality with the proper mixture ratio. Examples of the mixture ratio of coolant and water are shown in the following table:

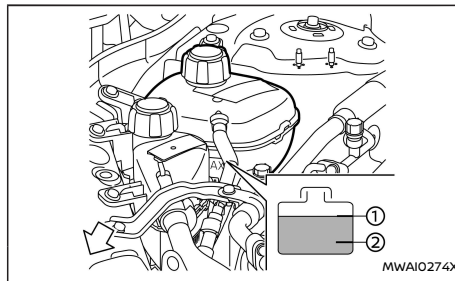
Outside temperature down to		Engine coolant (concentrated)	Demineralised or distilled water
°C	°F		
-15	5	30%	70%
-35	-30	50%	50%

Use Genuine NISSAN Engine Coolant or equivalent in its quality. Genuine NISSAN Engine Coolant is a pre-mixed (mixture ratio 50%) type coolant.

The use of other types of coolant solutions may damage the engine cooling system.

The radiator is equipped with a pressure cap. To prevent engine damage, use only a Genuine NISSAN radiator cap or its equivalent when replacement is required.

CHECKING ENGINE COOLANT LEVEL



Check the coolant level **in the reservoir when the engine is cold**. If the coolant level is below the MIN

level ②, open the reservoir cap and add coolant up to the MAX level ①.

Tighten the cap securely after adding engine coolant.

If the cooling system frequently requires coolant, have it checked. It is recommended you visit a NISSAN dealer or qualified workshop for this service.

CHANGING ENGINE COOLANT

A NISSAN dealer or qualified workshop can change the engine coolant. The service procedure can be found in the NISSAN Service Manual.

Improper servicing can result in reduced heater performance and engine overheating.

⚠ WARNING

- To avoid being scalded, never change the coolant when the engine is hot.
- Never remove the radiator or coolant reservoir cap when the engine is hot. Serious burns could be caused by high pressure fluid escaping from the coolant reservoir.
- Avoid direct skin contact with used coolant. If skin contact is made, wash thoroughly with soap or hand cleaner as soon as possible.
- Keep coolant out of the reach of children and pets.

Engine coolant must be disposed of properly. Check your local regulations.

INVERTER COOLING SYSTEM

⚠ WARNING

- Never remove the radiator or coolant reservoir cap when the engine is hot. Wait until the engine cools down. Serious burns could be caused by high pressure fluid escaping from the radiator or coolant reservoir.
- The coolant reservoir is equipped with a pressure type coolant reservoir cap. To prevent engine and inverter damage, use only a genuine NISSAN coolant reservoir cap.

The inverter cooling system is filled at the factory with a high-quality, year-round, anti-freeze coolant solution. The anti-freeze solution contains rust and corrosion inhibitors, therefore additional cooling system additives are not necessary.

CAUTION

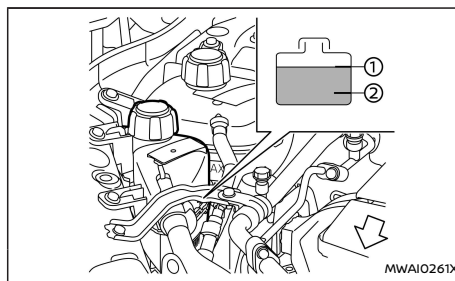
- Never use any additives in the coolant such as radiator sealer in the cooling system. This may cause damage to the inverter.
- When adding or replacing coolant, be sure to use only Genuine NISSAN Engine Coolant or equivalent in its quality with the proper mixture ratio. Examples of the mixture ratio of coolant and water are shown in the following tables:

Outside temperature down to		Coolant (concentrated)	Demineralsised or distilled water
°C	°F		
-15	5	30%	70%
-35	-30	50%	50%

The use of other types of coolant solutions may damage the inverter cooling system.

The inverter reservoir is equipped with a pressure cap. To prevent engine damage, use only a Genuine NISSAN inverter reservoir cap or its equivalent when replacement is required.

CHECKING INVERTER COOLANT LEVEL



Check the coolant level in the reservoir when the engine is cold. If the coolant level is below the MIN level ②, add coolant to the MAX level ①.

Tighten the cap securely after adding inverter coolant.

If the inverter cooling system frequently requires coolant, have it checked. It is recommended you visit a NISSAN dealer or qualified workshop for this service.

CHANGING INVERTER COOLANT

Inverter coolant is maintenance-free.

If replacement is required, it is recommended you visit a NISSAN dealer or qualified workshop for this service.

Improper servicing can result in inverter overheating.

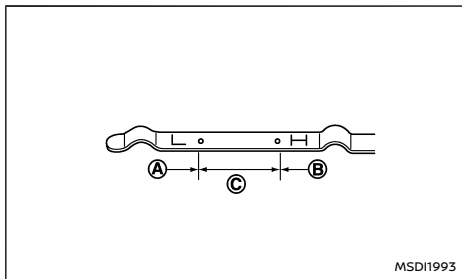
⚠ WARNING

- To avoid the danger of being scalded, never change the coolant when the engine is hot.
- Never remove the radiator or coolant reservoir cap when the engine is hot. Serious burns could be caused by high pressure fluid escaping from the radiator or coolant reservoir.
- Avoid direct skin contact with used coolant. If skin contact is made, wash thoroughly with soap or hand cleaner as soon as possible.
- Keep coolant out of the reach of children and pets.

Inverter coolant must be disposed of properly. Check your local regulations.

ENGINE OIL

CHECKING ENGINE OIL LEVEL



1. Park the vehicle on a level surface and apply the parking brake.
2. Start the engine and warm it up until the engine temperature reaches the normal operating temperature (approximately 5 minutes).
3. Stop the engine.
4. Wait at least 15 minutes for the engine oil to drain back to the oil pan.
5. Remove the dipstick and wipe it clean.
6. Reinsert the dipstick all the way.
7. Remove the dipstick and check the oil level. It should be within the range **C**.
8. If the oil level is below **A**, remove the oil filler cap and pour the recommended oil into the opening. Do not overfill **B**.

When filling the engine oil, do not remove the dipstick.

9. Recheck the oil level with the dipstick.

It is normal to add some oil between oil maintenance intervals or during the running-in period, depending on the severity of operating conditions.

CAUTION

The oil level should be checked regularly. Operating your vehicle with an insufficient amount of oil can damage the engine, and such damage is not covered by warranty.

CHANGING ENGINE OIL AND FILTER

⚠ WARNING

- **Used oil must be disposed of properly. Never pour or dump oil into the ground, canals, rivers, etc. It should be disposed of at proper waste facilities. NISSAN recommends having your oil changed by a NISSAN dealer or qualified workshop.**
- **Be careful not to burn yourself, as the engine oil may be hot.**
- **Prolonged and repeated contact with used engine oil may cause skin cancer.**
- **Avoid direct skin contact with used oil. If contacted, wash thoroughly with soap or hand cleaner and plenty of water as soon as possible.**
- **Store used engine oil in marked containers out of the reach of children.**

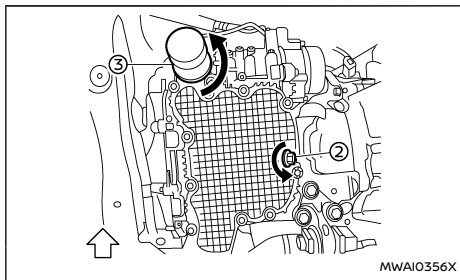
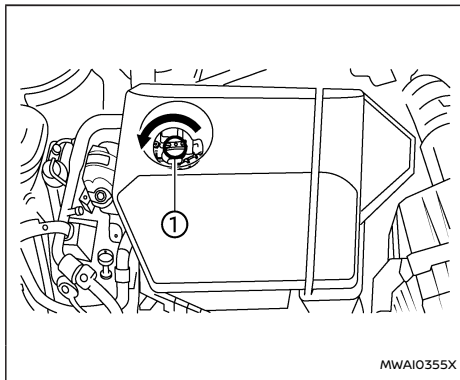
Vehicle set-up

1. Park the vehicle on a level surface and apply the parking brake.
2. Run the engine until it reaches the operating temperature.
3. Turn the engine off and wait more than 15 minutes.
4. Raise and support the vehicle using a suitable floor jack and safety jack stands.
 - Place the safety jack stands under the vehicle jack-up points.
 - A suitable adapter should be attached to the jack stand saddle.
5. Remove the engine undercover.
 - Remove clips at the around of the undercover.
 - Then remove the other bolts that hold the undercover in place.

CAUTION

Make sure the correct lifting and support points are used to avoid vehicle damage.

Engine oil and filter



- ① Oil filler cap
- ② Oil drain plug

③ Oil filter

1. Place a large drain pan under the drain plug.
2. Remove the oil filler cap.
3. Remove the drain plug with a wrench and completely drain the oil.

CAUTION

Be careful not to burn yourself, as the engine oil is hot.

⚠ WARNING

- Prolonged and repeated contact with used engine oil may cause skin cancer.
- Try to avoid direct skin contact with used oil. If skin contact is made, wash thoroughly with soap or hand cleaner as soon as possible.
- Keep used engine oil out of reach of children.

- Waste oil must be disposed of properly.
- Check your local regulations.

(Perform steps 4 to 7 only when the engine oil filter change is needed.)

4. Loosen the oil filter with an oil filter wrench. Remove the oil filter by turning it by hand.
5. Wipe the engine oil filter mounting surface with a clean rag.

CAUTION

- Be sure to remove any old gasket material remaining on the mounting surface of the engine. Failure to do so could lead to engine damage.
- The dipstick must be inserted in place to prevent oil spillage from the dipstick hole when filling the engine with oil.

6. Coat the gasket on the new filter with clean engine oil.
7. Screw in the oil filter clockwise until a slight resistance is felt, then tighten additionally more than 2/3 turn.

Oil filter tightening torque:

15.0 to 21.0 N·m

(1.5 to 2.1 kg·m, 11 to 15 ft·lb)

8. Clean and re-install the drain plug with a new washer. Securely tighten the drain plug with a wrench.

Drain plug tightening torque:

30.0 to 37.0 N·m

(3.1 to 3.8 kg·m, 22 to 27 ft·lb)

Do not use excessive force.

9. Refill the engine with the recommended oil through the oil filler opening, and install the oil filler cap securely.

See "Recommended fluids/lubricants and capacities" (P.456) for drain and refill capacity. The drain and refill capacity depends on the oil temperature and drain time. Use these specifications for reference only. Always use the

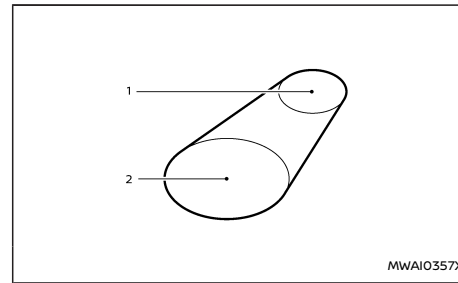
DRIVE BELT

dipstick to determine the proper amount of oil in the engine.

10. Start the engine and check for leakage around the drain plug and the oil filter. Correct as required.
11. Turn the engine off and wait more than 10 minutes. Check the oil level with the dipstick. Add engine oil if necessary.

After the operation

1. Reinstall undercover in reverse order of removal.
2. Lower the vehicle carefully to the ground.
3. Reset the Oil Control System and oil and filter maintenance reminder. (See "Maintenance" (P.98).)



1. Water pump
2. Crankshaft pulley

⚠ WARNING

Be sure the power switch is in the OFF position before servicing drive belts. The engine could rotate unexpectedly.

1. Visually inspect the belt for signs of unusual wear, cuts or fraying. If the belt is in poor condition, have it replaced. It is recommended that you visit a NISSAN dealer or qualified workshop for this service.
2. Have the belt condition checked regularly.

SPARK PLUGS

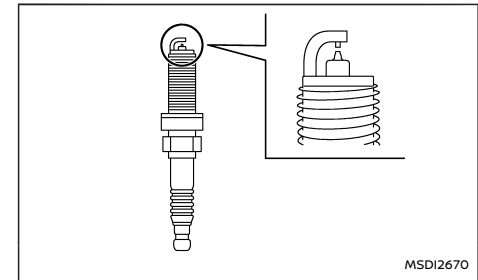
⚠ WARNING

Be sure the engine and power switch are off and that the parking brake is applied.

CAUTION

Be sure to use the correct socket to remove the spark plugs. An incorrect socket can damage the spark plugs.

REPLACING SPARK PLUGS



If replacement is required, it is recommended you visit a NISSAN dealer or qualified workshop for this service.

Iridium platinum-tipped spark plugs

It is not necessary to replace the iridium platinum-tipped spark plugs as frequently as the conventional type spark plugs since they will last much longer. Follow the maintenance schedule shown in a separate maintenance booklet. Do not reuse the

BRAKES

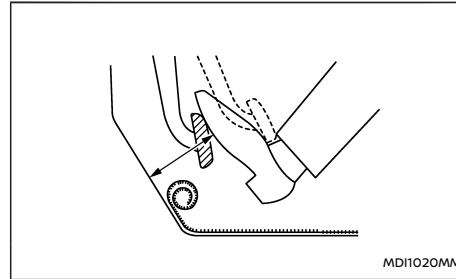
iridium platinum-tipped spark plugs by cleaning or regapping.

Always replace spark plugs with recommended or equivalent ones.

CHECKING PARKING BRAKE

Periodically check the holding ability of the parking brake by parking on a steep hill and restraining the vehicle by using only the parking brake. If it does not hold satisfactorily, see a NISSAN dealer or qualified workshop.

CHECKING FOOTBRAKE



⚠ WARNING

See a NISSAN dealer or qualified workshop for a brake system check if the brake pedal height does not return to normal.

With the e-POWER system running, check the distance between the upper surface of the pedal and the metal floor. If it is out the range listed, see a NISSAN dealer or qualified workshop.

Depressing force
490 N (50 kg, 110 lb)

LHD model	RHD model
70 mm (2.8 in) or more	80 mm (3.1 in) or more

Self-adjusting brakes

Your vehicle is equipped with self-adjusting brakes.

The disc-type brakes self-adjust every time the brake pedal is applied.

⚠ WARNING

Have your brake system checked if the brake pedal height does not return to normal. It is recommended you visit a NISSAN dealer or qualified workshop for this service.

Brake pad wear warning

The disc brake pads have audible wear warnings. When a brake pad requires replacement, it will make a high pitched scraping sound when the vehicle is in motion. This scraping sound will first occur only when the brake pedal is depressed. After more wear of the brake pad, the sound will always be heard even if the brake pedal is not depressed. Have the brakes checked as soon as possible if the wear warning sound is heard.

Under some driving or climate conditions, occasional brake squeaks, squeals or other noises may be heard. Occasional brake noise during light to moderate stops is normal and does not affect the function or performance of the brake system.

Proper brake inspection intervals should be followed. For additional information, see a separate maintenance booklet.

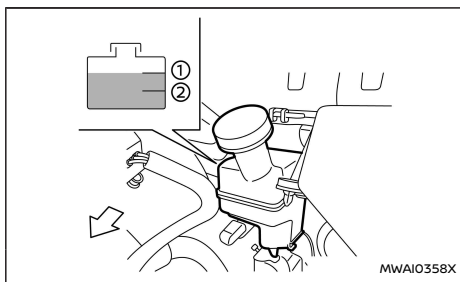
BRAKE FLUID

⚠ WARNING

- Use only new fluid from a sealed container. Old, inferior, or contaminated fluid may damage the brake system. The use of improper fluids can damage the brake system and affect the vehicle's stopping ability.
- Clean the filler cap before removing.
- Brake fluid is poisonous and should be stored carefully in marked containers out of the reach of children.

CAUTION

Do not spill the fluid on painted surfaces. This will damage the paint. If fluid is spilled, wash it off with plenty of water immediately.



Check the fluid level in the reservoir. If the fluid is below the MIN line ②, the brake warning light will illuminate. Add fluid up to the MAX line ①. (See

"Recommended fluids/lubricants and capacities" (P.456) for recommended types of fluid.)

If the fluid must be added frequently, the system should be thoroughly checked by a NISSAN dealer or qualified workshop.

Replace the brake fluid according to the maintenance log shown in a separate maintenance booklet.

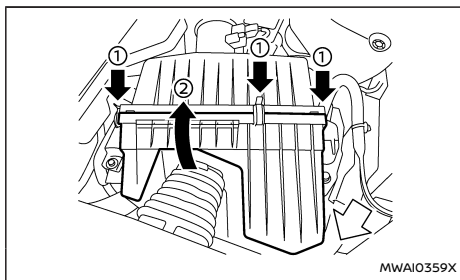
GEAR FLUID

When checking or replacement is required, we recommend a NISSAN dealer or qualified workshop for servicing.

CAUTION

- Use only Genuine NISSAN Matic S ATF. Do not mix with other fluids.
- Using gear fluid other than Genuine NISSAN Matic S ATF will cause deterioration in driveability and gear box durability, and may damage the gear box, which is not covered by the warranty.

AIR CLEANER



⚠ WARNING

Operating the engine with the air cleaner filter off can cause you or others to be burned. The air cleaner filter not only cleans the intake air, it also stops flame if the engine backfires. If the air cleaner filter is not installed and the engine backfires, you could be burned. Never drive with the air cleaner filter off. Be cautious working on the engine when the air cleaner filter is off.

To remove the filter, release the lock pins ① and pull the air cleaner cover upward ②.

It is not necessary to pull out the air cleaner unit when replacing the filter element.

The viscous paper type filter element should not be cleaned and reused. The dry paper type filter element may be cleaned and reused. Replace the air filter according to the maintenance log shown in a separate maintenance booklet.

When replacing the air filter, wipe the inside of the air cleaner housing and the cover with a damp cloth.

WIPER BLADES

WINDSCREEN WIPER BLADES

Cleaning

If your windscreen is not clear after using the windscreen washer or if a wiper blade chatters when running, wax or other material may be on the blade or windscreen.

Clean the outside of the windscreen with a washer solution or a mild detergent. Your windscreen is clean if beads do not form when rinsing with clear water.

Clean each blade by wiping it with a cloth soaked in a washer solution or a mild detergent. Then rinse the blade with clear water. If your windscreen is still not clear after cleaning the blades and using the wiper, replace the blades.

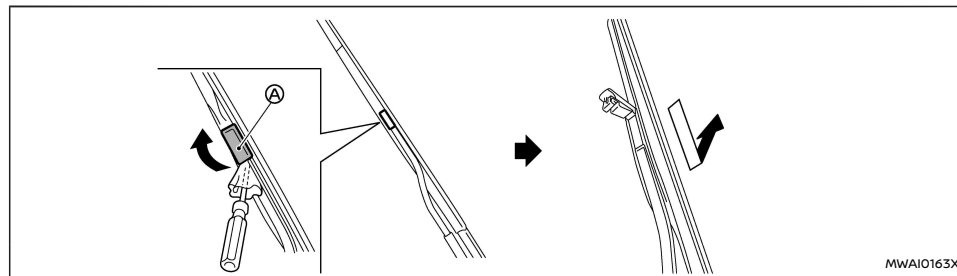
CAUTION

Worn windscreen wiper blades can damage the windscreen and impair driver vision.

When a washer nozzle is clogged:

It is recommended you see a NISSAN dealer or qualified workshop if a washer nozzle is clogged or any malfunction occurs. Do not attempt to clean the nozzle using a needle or a pin. Doing so may damage the nozzle.

Replacing



Replace the wiper blades if they are worn.

1. Lift the wiper arm away from the windscreen. **When lifting the wiper arm, lift the driver's side first, then the passenger's side. Otherwise, the wiper blades may be scratched and may cause damage.**
2. Open **A**, using a suitable tool, and then move the wiper blade down as shown to remove.
3. Insert the new wiper blade onto the wiper arm until a click sounds.
4. Close **A**.

CAUTION

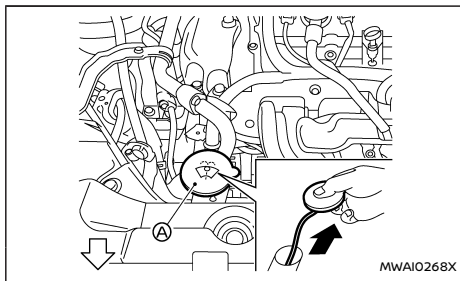
- **After wiper blade replacement, return the wiper arm to its original position; otherwise it may be damaged when the bonnet is opened.**
- **Make sure the wiper blades contact the**

glass; otherwise the arm may be damaged from wind pressure.

REAR WINDOW WIPER BLADE

It is recommended you contact a NISSAN dealer or qualified workshop if checking or replacement is required.

WINDOW WASHER FLUID



Check the fluid level in the window washer reservoir. Use your finger to plug the centre hole of the cap/tube assembly, then remove it from the reservoir. If there is no fluid in the tube, add window washer fluid.

Add a washer solvent to the washer for better cleaning. In the winter season, add a windscreen washer antifreeze. Follow the manufacturer's instructions for the mixture ratio.

Fill the window washer fluid reservoir periodically.

Refill the reservoir more frequently when driving conditions require an increased amount of window washer fluid.

CAUTION







- Do not substitute engine anti-freeze coolant for window washer solution. This may result in damage to the paint.
- Do not fill the window washer reservoir tank with washer fluid concentrates at full strength. Some methyl alcohol based

12-VOLT BATTERY

VEHICLE 12-VOLT BATTERY

washer fluid concentrates may permanently stain the grille if spilled while filling the window washer reservoir tank.

- Pre-mix washer fluid concentrates with water to the manufacturer's recommended levels before pouring the fluid into the window washer reservoir tank. Do not use the window washer reservoir tank to mix the washer fluid concentrate and water.

Caution symbols for battery			⚠ WARNING
①		No smoking No exposed flames No sparks	Never smoke around the battery. Never expose the battery to open flames or electrical sparks.
②		Shield eyes	Handle the battery cautiously. Always wear eye protection glasses to protect against explosion or battery acid.
③		Keep away from children	Never allow children to handle the battery. Keep the battery out of reach of children.
④		Battery acid	Do not allow battery fluid to contact your skin, eyes, fabrics, or painted surfaces. After handling the battery or battery cap, immediately wash your hands thoroughly. If the battery fluid gets into your eyes, or onto your skin or clothing, flush with water immediately for at least 15 minutes and seek medical attention. Battery fluid is acid. If the battery fluid gets into your eyes or onto your skin, it could cause eyesight loss or burns.
⑤		Note operating instructions	Before handling the battery, read this instructions carefully to ensure correct and safe handling.
⑥		Explosive gas	Hydrogen gas, generated by battery fluid, is explosive.

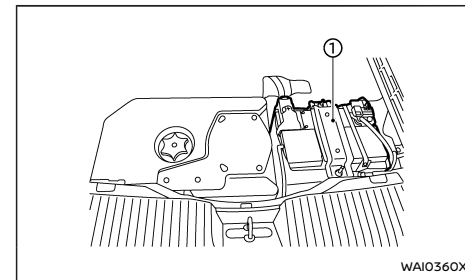
⚠ WARNING

Do not operate the vehicle if the fluid in the 12-volt battery is low. Low 12-volt battery fluid can cause a higher load on the 12-volt battery which can generate heat, reduce 12-volt bat-

tery life, and in some cases lead to an explosion.

For a maintenance free battery, it is not required to check the fluid level. However, NISSAN recom-

mends to check it periodically at a NISSAN dealer or qualified workshop.



The 12-volt battery ① is located on the luggage room. To access the 12-volt battery, raise the luggage floor board and remove the tool holder (s).

For a maintenance free battery, it is not required to check the fluid level. However, NISSAN recommends to check it periodically at a NISSAN dealer or qualified workshop.

CAUTION

Do not touch floor metal directly. Doing so could result in any burns.

Jump starting

If jump starting is necessary, see "Jump starting" (P.407). If the e-POWER system does not start by jump starting, the 12-volt battery may have to be replaced. It is recommended you visit a NISSAN dealer or qualified workshop for this service.

INTELLIGENT KEY BATTERY

⚠ WARNING

Do not ingest the battery, Chemical Burn Hazard

This product contains a coin/button cell battery. If the coin/button cell battery is swallowed, it can cause severe internal burns in just 2 hours and can lead to death.

Keep new and used batteries away from children. If the battery compartment does not close securely, stop using the product and keep it away from children.

If you think batteries might have been swallowed or placed inside any part of the body, seek immediate medical attention.



This symbol is intended to alert the user to the presence of important operating and maintenance (servicing) instructions in the literature accompanying the appliance.

⚠ WARNING

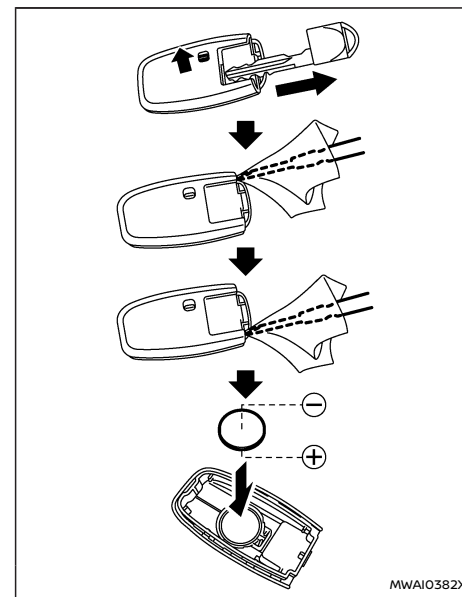
- Do not ingest the battery, Chemical Burn Hazard. This product contains a coin/button cell battery. If the coin/button cell battery is swallowed, it can cause severe internal burns in just 2 hours and can lead to death.
- Keep new and used batteries away from children. If the battery compartment does not close securely, stop using the product and keep it away from children.
- If you think batteries might have been

swallowed or placed inside any part of the body, seek immediate medical attention.

- There is danger of explosion if the battery is incorrectly replaced. Replace only with the same or equivalent type. Incorrectly replacing the battery can lead to injury or death.

CAUTION

- Be careful not to allow children to swallow the battery and removed parts.
- An improperly disposed battery can harm the environment. Always confirm local regulations for battery disposal.
- When changing batteries, do not let dust or oil get on the components.
- Do not expose the battery to excessive heat such as sunshine, fire or the like.
- Do not crush or cut the battery.
- Do not subject the battery to extremely low air pressure at high altitude.



Replace the battery in the Intelligent Key as follows:

1. Remove the mechanical key from the Intelligent Key.
2. Insert a small screwdriver into the slit of the corner (on the right and left sides) and twist it to separate the upper part from the lower part. Use a cloth to protect the casing.

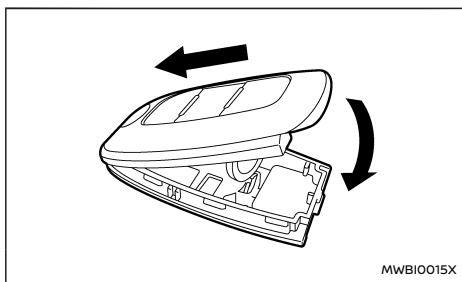
VARIABLE VOLTAGE CONTROL SYSTEM FUSES

- Replace the battery with a new one.

Recommended battery:

CR2032 or equivalent

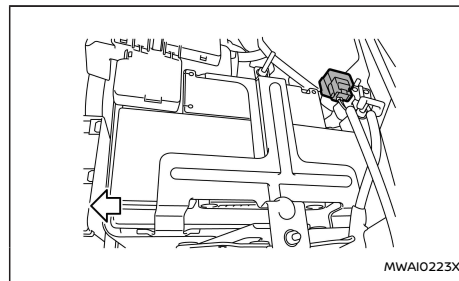
- Do not touch the internal circuit and electric terminals as doing so could cause a malfunction.
- Hold the battery by the edges. Holding the battery across the contact points will seriously deplete the storage capacity.
- Make sure that the \oplus side faces the bottom of the case.



- Align the tips of the upper and lower parts, and then push them together until it is securely closed.

- Operate the buttons to check its operation.

If you need any assistance for replacement, it is recommended you visit a NISSAN dealer or qualified workshop for this service.

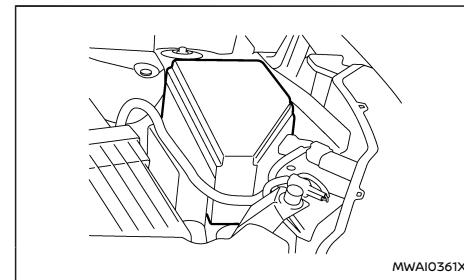


CAUTION

- Do not ground accessories directly to the 12-volt battery terminal. Doing so will bypass the variable voltage control system and the vehicle 12-volt battery may not charge completely.
- Use electrical accessories with the e-POWER system running to avoid discharging the vehicle 12-volt battery.

The variable voltage control system measures the amount of electrical discharge from the 12-volt battery and controls voltage generated by the generator.

ENGINE COMPARTMENT

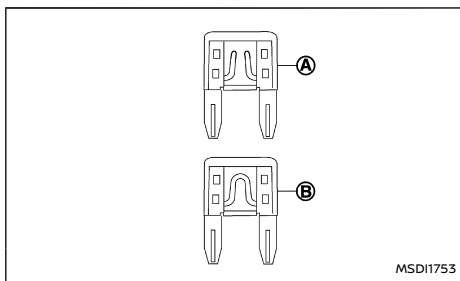


⚠ WARNING

Never use a fuse of a higher or lower amperage rating than that specified on the fuse box cover. This could damage the electrical system or electronic control units or cause a fire.

If any electrical equipment does not operate, check for an open fuse.

- Be sure the power switch is turned off and the headlights are off.
- Open the engine bonnet.
- Remove the fuse/fusible link box cover by pushing the tabs.
- Locate the fuse that needs to be replaced.
- Remove the fuse using the fuse puller located in the passenger compartment fuse box.



6. If the fuse is open (A), replace it with a new fuse (B).
7. If a new fuse also opens, have the electrical system checked and repaired. It is recommended you visit a NISSAN dealer or qualified workshop for this service.

Fusible links

If any electrical equipment does not operate and the fuses are in good condition, check the fusible links. If any of these fusible links are melted, replace only with genuine NISSAN parts.

For checking and replacing the fusible links, it is recommended you visit a NISSAN dealer or qualified workshop.

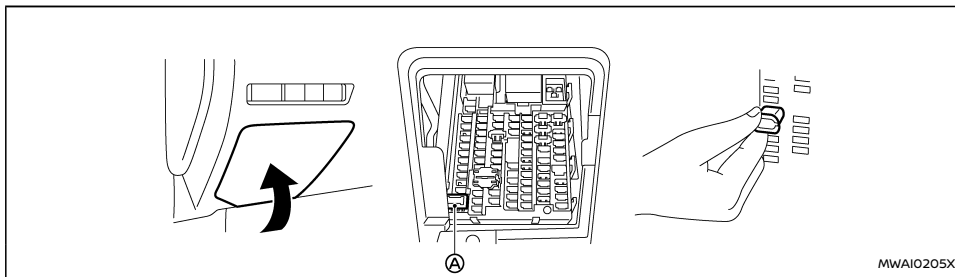
PASSENGER COMPARTMENT

⚠ WARNING

Never use a fuse of a higher or lower amperage rating than that specified on the fuse box cover. This could damage the electrical system or electronic control units or cause a fire.

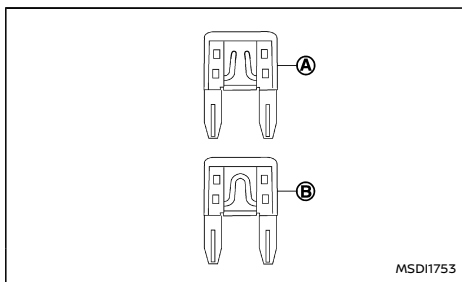
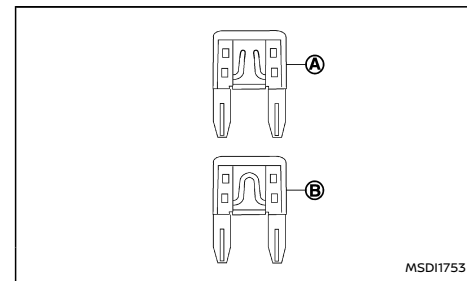
If any electrical equipment does not operate, check for an open fuse.

Left-Hand Drive (LHD) model



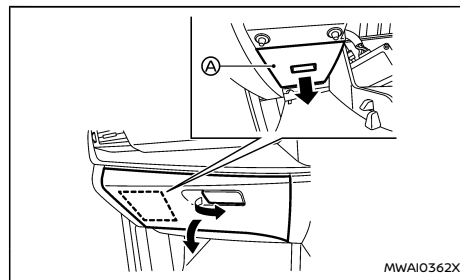
1. Be sure the power switch is turned off and the headlights are off.
2. Remove the fuse box cover.
3. Remove the fuse with the fuse puller (A).
5. If a new fuse also opens, have the electrical system checked and repaired. It is recommended you visit a NISSAN dealer or qualified workshop for this service.

1. Be sure the power switch is turned off and the headlights are off.
2. Open the glove box and remove the fuse box cover (A) inside the glove box.
3. Remove the fuse with the fuse puller. (The fuse puller is located as shown in the illustration for LHD models.)



4. If the fuse is open (A), replace it with a new fuse (B).

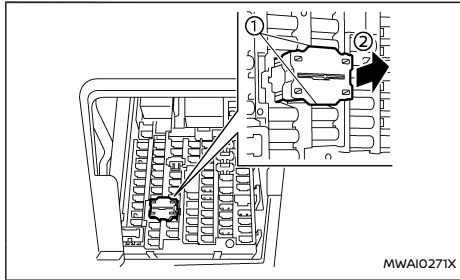
Right-Hand Drive (RHD) model



4. If the fuse is open (A), replace it with a new fuse (B).
5. If a new fuse also opens, have the electrical system checked and repaired. It is recommended you visit a NISSAN dealer or qualified workshop for this service.

LIGHTS

Extended storage switch (where fitted)

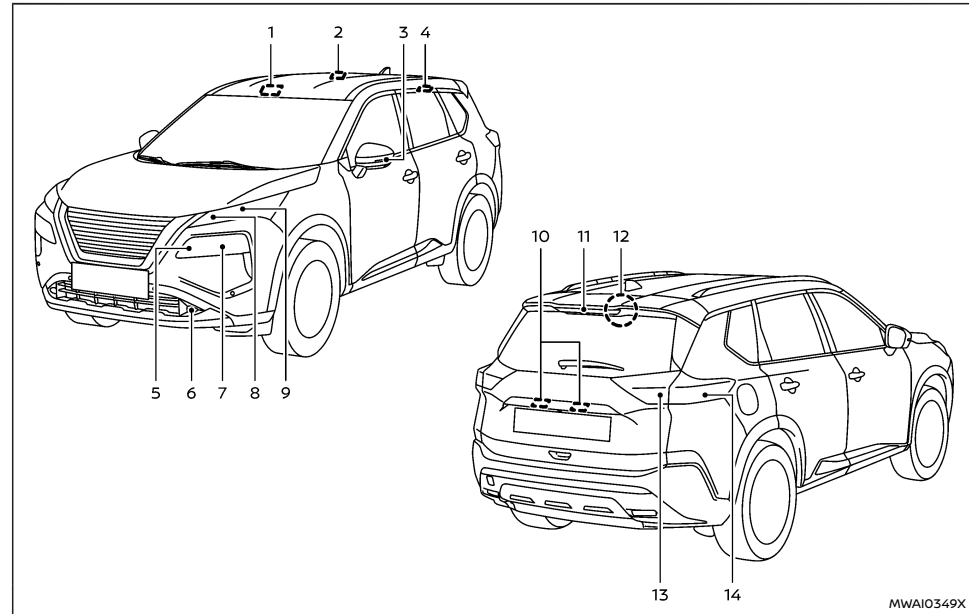


The extended storage switch is used when shipping the vehicle. It is located in the fuse panel. If any electrical equipment does not operate, ensure the extended storage switch is pushed fully in place.

To inspect the extended storage switch, ensure the power switch and headlights are off.

How to remove the extended storage switch:

1. To remove the extended storage switch, be sure the power switch is in the OFF position.
2. Be sure the headlights are off.
3. Remove the fuse box cover.
4. Pinch the locking tabs ① on top and bottom of the extended storage switch.
5. Pull the extended storage switch straight out from the fuse panel ②.



- | | |
|---------------------------------------|---|
| 1. Map light | 7. Headlight (low-beam) |
| 2. Room light (where fitted) | 8. Front clearance light/Daytime running light/
Front turn signal light (LED type) |
| 3. Side turn signal light | 9. Front turn signal light (Bulb type) |
| 4. Rear personal light (where fitted) | 10. Number plate light |
| 5. Headlight (high-beam) | 11. High-mounted brake light |
| 6. Front fog light (where fitted) | |

12. Cargo light
 13. Reversing light/Tail light/Rear fog light*
 14. Rear turn signal light/brake light/Tail light
- *: Driver's side only

HEADLIGHTS

Fog may temporarily form inside the lens of the exterior lights in the rain or in a car wash. A temperature difference between the inside and the outside of the lens causes the fog. This is not a malfunction. If large drops of water collect inside the lens, it is recommended you visit a NISSAN dealer or qualified workshop for servicing.

Replacing

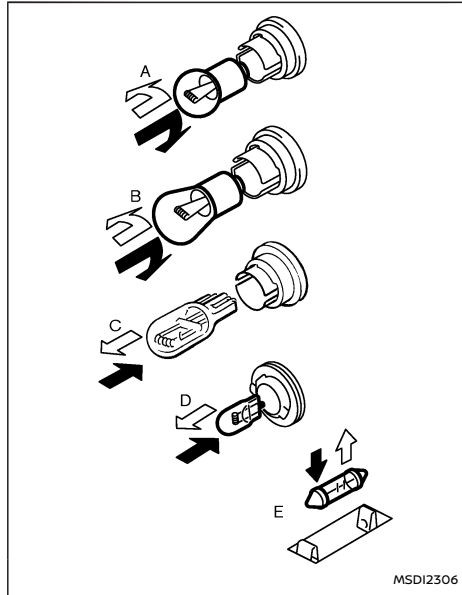
If LED headlight replacement is required, it is recommended that you visit a NISSAN dealer or qualified workshop for this service.



EXTERIOR AND INTERIOR LIGHTS

Item	Wattage (W)
Headlight high/low beams*	LED
Front turn signal light*	21 or LED
Front clearance light*	LED
Front fog light (where fitted)*	LED
Side turn signal light*	LED
Daytime running light*	LED
Rear combination light*	
Turn signal light	21
Brake light	LED
Tail light	LED
Reversing light	16
Rear fog light*	LED
Number plate light*	5 (assembly)
Map light*	16
Rear personal light (where fitted)*	10
High-mounted brake light*	LED
Room light (where fitted)*	16
Cargo light	5
Console light*	1.4 or LED
Lower centre light*	1.4 or LED
Glove box light*	1.4

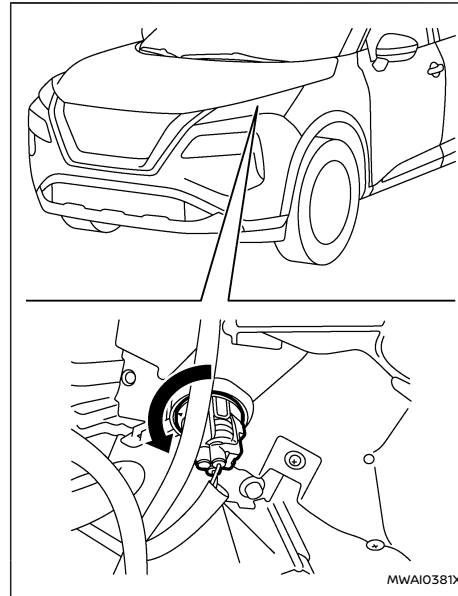
*: It is recommended you visit a NISSAN dealer or qualified workshop for replacement.

Replacement procedures

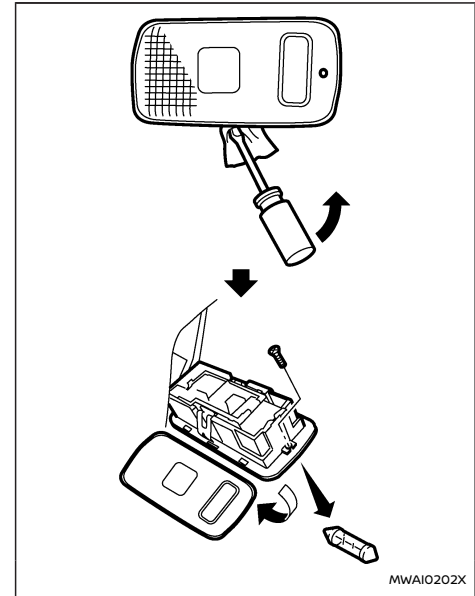


-  REMOVE
-  INSTALL

All other lights are either type A, B, C, D or E. When replacing a bulb, first remove the lens and/or cover.



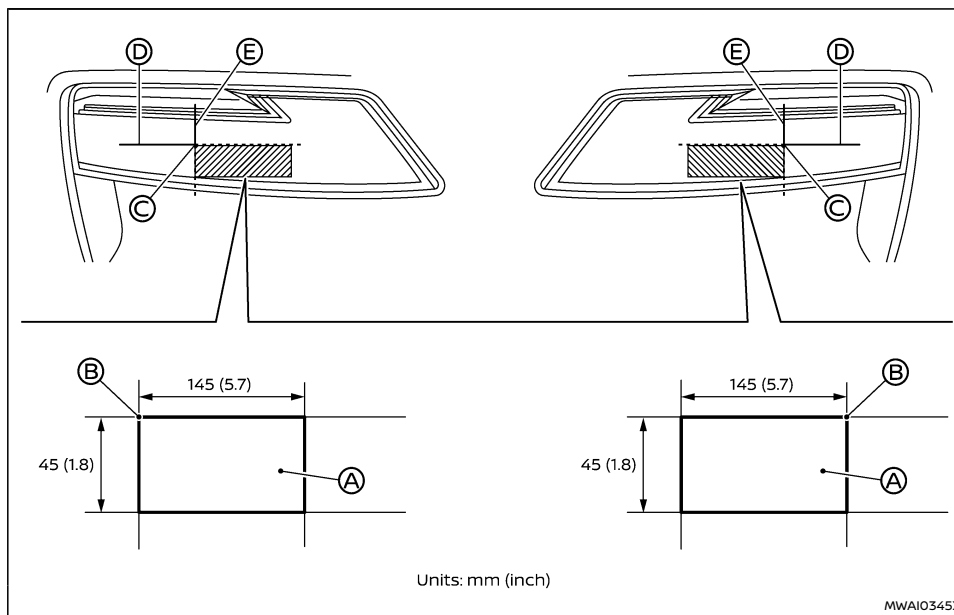
Front turn signal light (bulb type)



Cargo light

LEGAL REQUIREMENT TO ADJUST HEADLIGHT BEAM

When the vehicle is driven in a country where the driving lane is different to your home country, affix an opaque sticker on the headlight.



located on the surface of the headlight seen from front.

Affix the sticker as illustrated by aligning the mark © with dividing lines © and ©.

NOTE:

Align the mark © with the centre mark © of the LED headlight.

1. Place the power switch in the OFF position and wait until the headlights cool down.
2. Prepare the stickers referring to the figure. Make the stickers © that will be affixed to the surface of the right side headlight and the left side headlight.

NOTE:

- Use an opaque material that prevents the light from passing through it.
 - Note that other transparent materials do not work effectively.
3. Affix the sticker by aligning the corner © of the sticker with the position of the mark © that is

TYRES AND WHEELS

If you have a flat tyre, see “Flat tyre” (P.403).

TYRE PRESSURE MONITORING SYSTEM (TPMS)

The Tyre Pressure Monitoring System (TPMS) monitors tyre pressure of all tyres. When the low tyre pressure warning light is lit, one or more of your tyres is significantly under-inflated.

The TPMS will activate only when the vehicle is driven at speeds above 25 km/h (16 MPH). Also, this system may not detect a sudden drop in tyre pressure (for example a flat tyre while driving).

For more details, see “Low tyre pressure warning light” (P.87), “Tyre Pressure Monitoring System (TPMS)” (P.231) and “Tyre Pressure Monitoring System (TPMS)” (P.403).

TYRE INFLATION PRESSURE

Periodically check the pressure of the tyres. An incorrect tyre pressure may adversely affect tyre life and vehicle handling. The tyre pressure should be checked when tyres are COLD. Tyres are considered COLD after the vehicle has been parked for 3 or more hours, or driven less than 1.6 km (1 mile). COLD tyre pressures are shown on the tyre placard.

Insufficient pressure can lead to an overheating of the tyre and subsequent internal damage. At high speeds, this could result in tread separation and even bursting of the tyre.

TYPES OF TYRES

CAUTION

When changing or replacing tyres, be sure all four tyres are of the same type (that is, summer, all season or snow) and construction. A NISSAN dealer or qualified workshop may be able to help you with information about tyre type, size, speed rating and availability.

Replacement tyres may have a lower speed rating than the factory equipped tyres, and they may not match the potential maximum vehicle speed. Never exceed the maximum speed rating of the tyre.

All season tyres

NISSAN specifies all season tyres on some models to provide good performance all year, including snowy and icy road conditions. All season tyres are identified by ALL SEASON and/or M&S on the tyre sidewall. Snow tyres have better snow traction than all season tyres and may be more appropriate in some areas.

Summer tyres

NISSAN specifies summer tyres on some models to provide superior performance on dry roads. Summer tyre performance is substantially reduced in snow and ice. Summer tyres do not have the tyre traction rating M&S on the tyre sidewall.

If you plan to operate your vehicle in snowy or icy conditions, NISSAN recommends the use of snow or all season tyres on all four wheels.

Snow tyres

If snow tyres are needed, it is necessary to select tyres equivalent in size and load rating to the original equipment tyres. If you do not, it can adversely affect the safety and handling of your vehicle.

Generally, snow tyres have lower speed ratings than factory equipped tyres and may not match the potential maximum vehicle speed. Never exceed the maximum speed rating of the tyre. If you install snow tyres, they must be the same size, brand, construction and tread pattern on all four wheels.

For additional traction on icy roads, studded tyres may be used. However, some states and provinces prohibit their use. Check local, state and provincial laws before installing studded tyres. Skid and traction capabilities of studded snow tyres on wet or dry surfaces may be poorer than that of non-studded snow tyres.

TYRE CHAINS

CAUTION

- **Tyre chains/cables should not be installed on 255/45 R20 tyres. Doing so will cause damage to the vehicle.**
- **If you plan to use tyre chains/cables, you should install 235/60 R18 or 235/55 R19 tyres on your vehicle.**

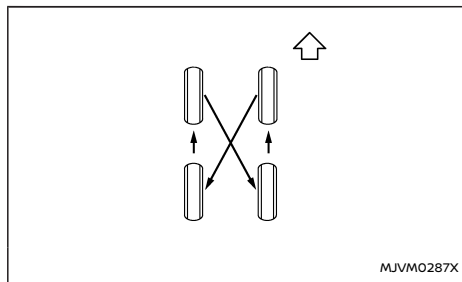
Use of tyre chains may be prohibited according to location. Check the local laws before installing tyre chains. When installing tyre chains, make sure they

are the proper size for the tyres on your vehicle and are installed according to the chain manufacturer's suggestions. The minimum clearances are determined using the factory equipped tyre size. Other types may damage your vehicle. Use chain tensioners when recommended by the tyre chain manufacturer to ensure a tight fit. Loose end links of the tyre chain must be secured or removed to prevent the possibility of whipping action damage to the fenders or underbody. If possible, avoid fully loading your vehicle when using tyre chains. In addition, drive at a reduced speed. Otherwise, your vehicle may be damaged and/or vehicle handling and performance may be adversely affected.

Tyre chains must be installed only on the front wheels and not on the rear wheels.

Do not use tyre chains on dry roads. Driving with tyre chains in such conditions can cause damage to the various mechanisms of the vehicle due to some overstress.

TYRE ROTATION



NISSAN recommends that tyres be rotated every 5,000 km (3,000 miles) for Four-Wheel Drive (4WD) or every 10,000 km (6,000 miles) for Two-Wheel Drive (2WD) model. However, the timing for tyre rotation may vary according to your driving habits and the road surface conditions. (See "Flat tyre" (P.403) for the tyre replacement.)

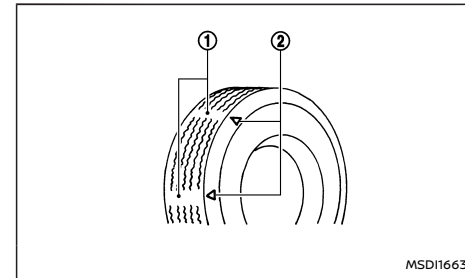
As soon as possible, tighten the wheel nuts to the specified torque with a torque wrench.

WARNING

- **After rotating the tyres, adjust the tyre pressure.**
- **Retighten the wheel nuts when the vehicle has been driven for 1,000 km (600 miles) (also in cases of a flat tyre, etc.).**
- **Incorrect tyre selection, fitting, care, or maintenance can affect vehicle safety with risk of accident and injury. If in doubt, consult a NISSAN dealer or qualified workshop or the tyre manufacturer.**

After the tyres are rotated, the TPMS must be reset. (See "Tyre Pressure Monitoring System (TPMS)" (P.231) for details about the resetting procedure.)

TYRE WEAR AND DAMAGE



- ① Wear indicator
- ② Wear indicator location marks. The locations are shown by " Δ ", "TWI", etc. depending on tyre types.

Tyres should be periodically inspected for wear, cracking, bulging or objects caught in the tread. If excessive wear, cracks, bulging or deep cuts are found, the tyre should be replaced immediately.

The original tyres have a built-in tread wear indicator. When the wear indicator is visible, the tyre should be replaced.

TYRE AGE

Never use a tyre over six years old, regardless of whether it has been used or not.

Tyres degrade with age as well as with the vehicle usage. Have your tyres checked and balanced often by a repair shop or, if you prefer, a NISSAN dealer or qualified workshop.

CHANGING TYRES AND WHEELS

WARNING

Do not install a deformed wheel or tyre even if it has been repaired. Such wheels or tyres could have structural damage and could fail without warning.

When replacing a tyre, use the same size, speed rating and load carrying capacity as originally equipped. (See "Tyres and Wheels" (P.447) for recommended types and sizes of tyres and wheels.) The use of tyres other than those recommended or the mixed use of tyres of different brands, construction (bias, bias-belted, or radial), or tread patterns can adversely affect the ride, braking, handling, ground clearance, body-to-tyre clearance, snow chain clearance, Tyre Pressure Monitoring System (TPMS), speedometer calibration, headlight aim and bumper height. Some of these effects may lead to accidents and could result in serious personal injury.

If the wheels are changed for any reason, always replace with wheels which have the same offset dimension. Wheels of a different offset could cause early tyre wear, possibly degraded vehicle handling characteristics and/or interference with the brake discs/drums. Such interference can lead to decreased braking efficiency and/or early brake pad/shoe wear.

Confirm the following for the TPMS.

WARNING

- If your vehicle was originally equipped with 4 tyres that were the same size and you are only replacing 2 of the 4 tyres, install the new tyres on the rear axle. Placing new tyres on the front axle may cause loss of vehicle control in some driving conditions and cause an accident and personal injury.
- After a tyre or a wheel is replaced, the TPMS must be reset. (See "Tyre Pressure Monitoring System (TPMS)" (P.231) for details about the resetting procedure.)
- Replacing tyres with those not originally specified by NISSAN could affect the proper operation of the TPMS.
- The TPMS sensor may be damaged if it is not handled correctly. Be careful when handling the TPMS sensor.
- When replacing the TPMS sensor, the ID registration may be required. Contact a NISSAN dealer or qualified workshop for ID registration.
- Do not use a valve stem cap that is not specified by NISSAN. The valve stem cap may become stuck.
- Be sure that the valve stem caps are correctly fitted. Otherwise the valve may be clogged up with dirt and cause a malfunction or loss of pressure.
- Do not install a damaged or deformed wheel or tyre even if it has been repaired. Such wheels or tyres could have structural damage and could fail without warning.

- The use of retread tyre is not recommended.

Four-Wheel Drive (4WD) model

CAUTION

Always use tyres of the same size, brand, construction (bias, bias-belted or radial), and tread pattern on all four wheels. Failure to do so may reduce 4WD performance.

If excessive tyre wear is found, it is recommended that all four tyres be replaced with tyres of the same size, brand, construction and tread pattern. The tyre pressure and wheel alignment should also be checked and corrected as necessary. Contact a NISSAN dealer or qualified workshop.

WHEEL BALANCE

Unbalanced wheels may affect vehicle handling and tyre life. Even with regular use, wheels can get out of balance. Therefore, they should be balanced as required.

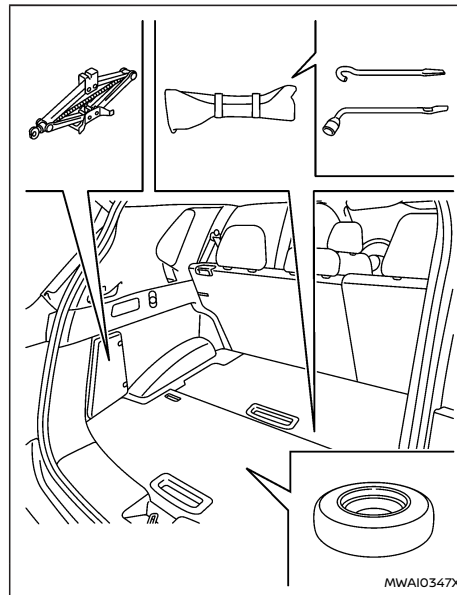
JACKING UP VEHICLE AND REPLACING TYRES

This section provides the information about the vehicle jack-up procedures and the tyre replacement.

You can temporarily fix a minor tyre puncture using the emergency tyre puncture repair kit. (See "Repairing flat tyre" (P.403).)

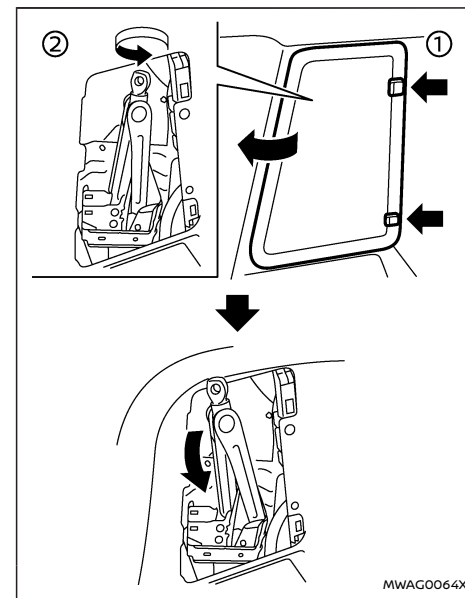
⚠ WARNING

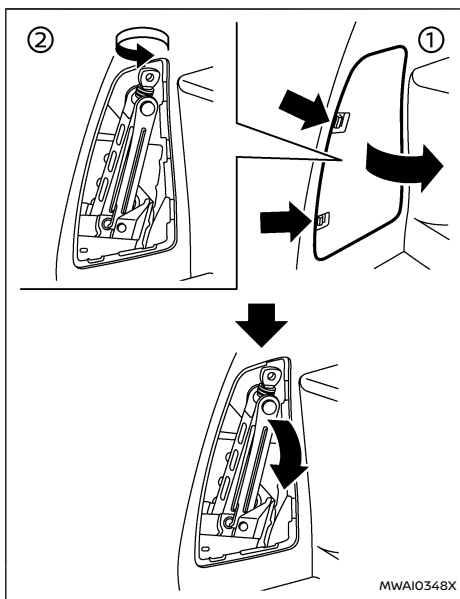
- Be sure to apply the parking brake firmly.
- Be sure to press the P position switch to engage the P (Park) position.
- Never change tyres when the vehicle is on a slope, ice or slippery area. This is hazardous.
- Never change tyres when the oncoming traffic is close to your vehicle. Call for professional road assistance.

Preparing tools**Model with adjustable luggage floor**

Open the back door. Raise the luggage floor board. Remove the jacking tools.

The jack, jack rod and wheel nut wrench are not equipped as standard with this vehicle. Contact a NISSAN dealer or qualified workshop about acquiring the tools.

**Two row model**



Three row model

To remove the jack:

1. Remove the storage door by pressing the two release tabs simultaneously.
2. Turn the jack lever in a counter-clockwise direction, and then remove the jack slowly.

When storing the jack, set the jack slowly back, then turn the jack lever in a clockwise direction until the jack is fixed.

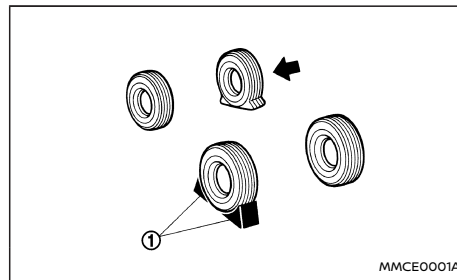
CAUTION

- Do not touch floor metal directly. Doing so could result in any burns.
- When removing the jack, be careful that your hands do not hit against the vehicle. Otherwise, this could result in personal injury.
- When removing or storing the jack, be careful not to drop it in the storage area. It may damage the surrounding parts, etc. If you drop it, have the vehicle checked by a NISSAN dealer or qualified workshop.

NOTE:

- When storing the jack, do not overtighten the jack lever using a screw driver. Doing so could cause deformation of the installation area for the jack.
- Do not allow the jack to contact the interior parts. Doing so could cause damage to the vehicle.

Blocking wheels



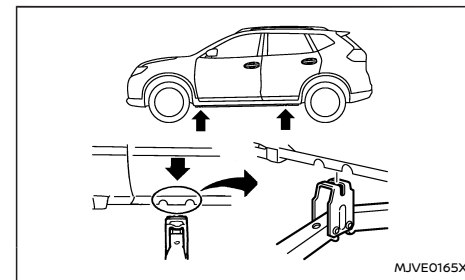
⚠ WARNING

Be sure to block the appropriate wheel to prevent the vehicle from moving, which may cause personal injury.

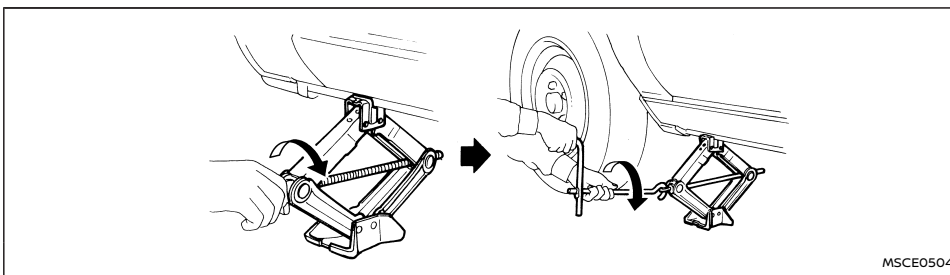
Place suitable blocks ① at both the front and back of the wheel diagonally opposite the flat tyre ← to prevent the vehicle from moving when it is jacked up.

Removing tyre

Jacking up vehicle:



jacking up points



MSCE0504

⚠ WARNING

- Be sure to read and follow the instructions in this section.
- **DO NOT GET UNDER A VEHICLE THAT IS SUPPORTED BY A JACK.**
- Never use a jack which was not provided with your vehicle.
- The jack, which is provided with your vehicle, is designed only to lift your vehicle during a tyre change. Do not use the jack provided with your vehicle on other vehicles.
- Never jack up the vehicle at a location other than the jack-up point that is specified.
- Never lift the vehicle more than necessary.
- Never use blocks on or under the jack.
- Never start the vehicle while the vehicle is on the jack. The vehicle may move suddenly, and this may cause an accident.

- Never allow passengers to remain in the vehicle while the tyre is off the ground.
- Be sure to read the caution label attached to the jack body before using.
- When jacking up the vehicle, be sure to apply the parking brake.

1. Place the jack directly under the jack-up point as illustrated so that the top of the jack contacts the vehicle at the jack-up point.

The jack should be placed on firm level ground.

2. Align the jack head between the two notches located at the jack-up point of either the front or the rear section.
3. Fit the groove of the jack head between the notches as shown.
4. Loosen each wheel nut, anticlockwise, one or two turns with the wheel nut wrench.

Do not remove the wheel nuts until the tyre is off the ground.

5. Carefully raise the vehicle until the clearance between the tyre and ground is achieved.
6. To lift the vehicle, securely hold the jack lever and rod with both hands and turn the jack lever.

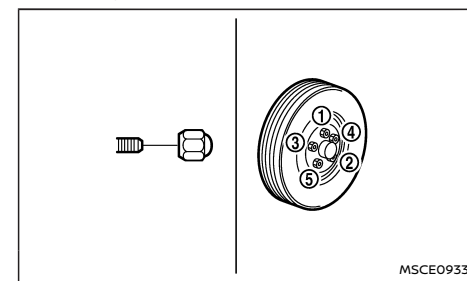
Removing tyre:

1. Remove the wheel nuts.
2. Remove the damaged tyre.

CAUTION

The tyre is heavy. Be sure that your feet are clear from the tyre and use gloves as necessary to avoid injury.

Installing tyre



MSCE0933

⚠ WARNING

- Never use wheel nuts which are not provided with your vehicle. Incorrect wheel nuts or improperly tightened wheel nuts

may cause the wheel to become loose or come off. This could cause an accident.

- Never use oil or grease on the wheel studs or nuts. This may cause the wheel nuts to become loose.

1. Clean any mud or dirt from the surface between the wheel and hub.
2. Carefully put the tyre on and tighten the wheel nuts with your fingers. Check that all the wheel nuts contact the wheel surface horizontally.
3. Tighten the wheel nuts alternately and evenly, more than 2 times in the sequence illustrated (① - ⑤), with the wheel nut wrench, until they are tight.
4. Lower the vehicle slowly until the tyre touches the ground.
5. Tighten the wheel nuts securely, with the wheel nut wrench, in the sequence illustrated.
6. Lower the vehicle completely.

Tighten the wheel nuts to the specified torque with a torque wrench as soon as possible.

**Wheel nut tightening torque:
108 N·m (11 kg·m, 80 ft·lb)**

The wheel nuts must be kept tightened to specification at all times. It is recommended that the wheel nuts be tightened to specification at each lubrication interval.

- After adjusting the tyre pressure, the TPMS must be reset. (See "Tyre Pressure Monitoring System (TPMS)" (P.231) for details about the resetting procedure.)

- After adjusting tyre pressure to the COLD tyre pressure, the display of the tyre pressures may show higher pressure than the COLD tyre pressure after the vehicle has been driven more than 1.6 km (1 mile). This is because the tyre pressurises as tyre temperature rises. This does not indicate a system malfunction.

Stowing damaged tyre and tools

WARNING

Be sure that the tyre, jack and tools used are properly stored after use. Such items can become dangerous projectiles in an accident or sudden stop.

1. Securely store the damaged tyre, jack and tools used in the storage area.
2. Replace the luggage floor board.
3. Close the back door.

EMERGENCY TYRE PUNCTURE REPAIR KIT

The emergency tyre puncture repair kit is supplied to the vehicle instead of a spare tyre. The kit must be used for temporarily fixing a minor tyre puncture. After using the repair kit, see a NISSAN dealer or qualified workshop as soon as possible for tyre inspection and repair/replacement.

See "Flat tyre" (P.403) for more details.

MEMO

9 Technical information

Recommended fluids/lubricants and capacities	456	Installation of an RF-transmitter	464
Fuel information	457	Event Data Recorders (EDR) (where fitted)	464
Recommended SAE viscosity number	457	Additional data recording (on vehicles equipped with optional ProPILOT Assist)	464
Air conditioner system refrigerant and lubricant	457	Additional data recording (on vehicles equipped with TSR system)	465
Engine	459	Radio approval number and information	466
Tyres and wheels	460	For Europe	466
Dimensions	460	For Ukraine	469
When travelling or registering in another country	461	For the United Kingdom	471
Vehicle identification	461	For Turkey	474
Vehicle identification label	461		
Vehicle Identification Number (VIN)	461		
Engine serial number	461		
Tyre placard	461		
Air conditioner specification label	462		

RECOMMENDED FLUIDS/LUBRICANTS AND CAPACITIES

The following are approximate capacities. The actual refill quantities may be slightly different. When refilling, follow the procedures instructed in the "8. Maintenance and do-it-yourself" section to determine the proper refill capacity.

Fluid type		Capacity (approximate)			Recommended Fluids/Lubricants
		Metric Measure	US Measure	Imperial Measure	
Fuel		55 L	14-1/2 gal	12-1/8 gal	· See "Fuel information" (P.457).
Engine oil ¹	With oil filter	5.1 L	5-3/8 qt	4-1/2 qt	<ul style="list-style-type: none"> · Genuine "NISSAN Motor Oil 0W-20 SP" is recommended. · If the above motor oil is not available, use "NISSAN Motor Oil" or equivalent that matches the following grade and viscosity. <ul style="list-style-type: none"> · Oil grade: <ul style="list-style-type: none"> – API: SP, ILSAC GF-6A · SAE Viscosity: See "Recommended SAE viscosity number" (P.457).
	Without oil filter	5.0 L	5-1/4 qt	4-3/8 qt	
Engine coolant	With reservoir	8.4 L	8-7/8 qt	7-3/8 qt	· Genuine NISSAN Engine Coolant or equivalent in its quality ²
	Reservoir	0.83 L	7/8 qt	3/4 qt	
Inverter coolant	With reservoir	2WD model	5.4 L	5-3/4 qt	4-3/4 qt
		4WD model	7.7 L	8-1/8 qt	6-3/4 qt
	Reservoir	0.55 L	5/8 qt	1/2 qt	
Gear fluid		—	—	—	<ul style="list-style-type: none"> · Genuine NISSAN Matic S ATF · Using gear fluid other than Genuine NISSAN Matic S ATF will cause deterioration in drivability and gear box durability, and may damage the gear box, which is not covered by the warranty.
Brake fluid		Refill to the proper fluid level according to the instructions in the "8. Maintenance and do-it-yourself" section.			<ul style="list-style-type: none"> · Genuine NISSAN Brake Fluid or equivalent DOT3 or DOT4 · Never mix different types of fluids (DOT3 and DOT4).
Multi-purpose grease		—	—	—	· NLGI No. 2 (Lithium soap base)
Air conditioner system refrigerant		—	—	—	· HFO-1234yf (R-1234yf) or HFC-134a (R-134a)
Air conditioner system lubricants		—	—	—	· AC system oil RB100EV (POE) or equivalent

FUEL INFORMATION

Petrol engine



Except for Ukraine:

CAUTION

- Do not use leaded petrol. Using leaded petrol will damage the three-way catalyst.
- Never use fuel additives. Additives may cause damage to the engine.

Compatible fuels for petrol engines

The petrol engines are compatible with current and future European standards for bio-fuel.

	<p>Petrol conforming to EN228 and mixed with a bio-fuel conforming to EN15376.</p> <p>Maximum bio-fuel content in petrol allowed by engine is 10%.</p>
	<p>CAUTION</p> <p>Damage to fuel system or performance problem caused by the use of fuel with excessive ethanol content may not be covered by your new vehicle warranty.</p>

Use UNLEADED PREMIUM petrol with an octane rating of at least 95 (RON).

If unleaded premium petrol is not used, UNLEADED REGULAR petrol with an octane rating of at least 91 (RON) may be used at slightly reduced performance. However, for maximum vehicle performance and the best driveability, the use of unleaded premium petrol is recommended.

For Ukraine:

CAUTION

Do not use leaded petrol. Using leaded petrol will damage the three-way catalyst.

Use UNLEADED REGULAR petrol with an octane rating of at least 91 (RON).

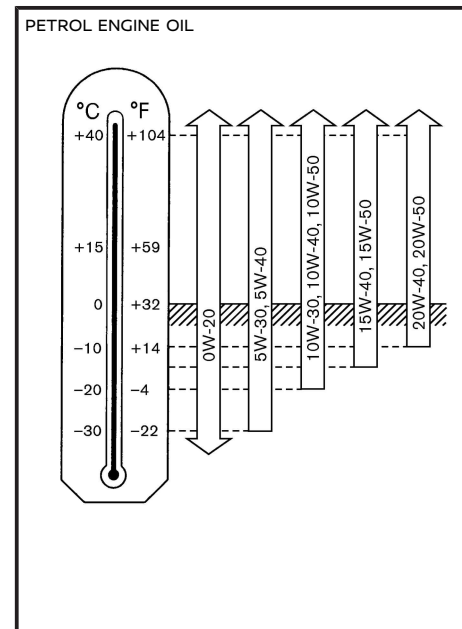
RECOMMENDED SAE VISCOSITY NUMBER

Petrol engine oil

0W-20 is preferable.

If 0W-20 is not available, select the viscosity, from the chart below, that is suitable for the outside temperature range.

Outside Temperature Range
Anticipated Before Next Oil Change



AIR CONDITIONER SYSTEM REFRIGERANT AND LUBRICANT

The air conditioner system of your vehicle must be charged with the refrigerant HFO-1234yf (R-1234yf) or HFC-134a (R-134a) and the lubricant AC system oil RB100EV (POE) or equivalent. Use of any other refrigerants or lubricants will cause severe damage, and you may need to replace your vehicle's entire air conditioner system.

The release of refrigerants into the atmosphere is prohibited in many countries and regions. The refrigerant in your vehicle will not harm the Earth's ozone layer. However, it may contribute in a small part to the global warming effect. NISSAN recommends that the refrigerant be appropriately recovered and recycled. Contact a NISSAN dealer or qualified workshop when servicing the air conditioner system.

ENGINE

Engine model	KR15DDT		
Type	Petrol, 4-cycle, DOHC		
Cylinder arrangement	3-cylinder, in-line		
Bore × Stroke	when compression ratio = 8	mm (in)	84.0 × 90.1 (3.307 × 3.547)
	when compression ratio = 14	mm (in)	84.0 × 88.9 (3.307 × 3.500)
Displacement	when compression ratio = 8	cm ³ (cu in)	1,497 (91.4)
	when compression ratio = 14	cm ³ (cu in)	1,477 (90.1)
Idle speed at the maintenance mode	rpm		1500±125
Ignition timing (B.T.D.C.) at the maintenance mode	degree at idle		15° to 25°
Spark plugs			
	Type	Standard	ILMAR8G8GS
	Gap	mm (in)	0.8 (0.031)
Camshaft operation	Timing chain		

TYRES AND WHEELS

		Standard	Spare
		235/60 R18	
Tyre size		235/55 R19	- (*)
		255/45 R20	

		Size	Offset mm (in)
Road wheel	Aluminium	18 × 7.5J	40 (1.57)
		19 × 7.5J	40 (1.57)
		20 × 8J	45 (1.77)
Spare	- (*)	- (*)	- (*)

*: The emergency tyre puncture repair kit is supplied.

DIMENSIONS

		Unit: mm (in)
Overall length	4,680	(184.3)
Overall width	1,840	(72.4)
Overall height	1,725	(67.9)
Front tread	1,585	(62.4)*1
	1,575	(62.0)*2
Rear tread	1,590	(62.6)*1
	1,580	(62.2)*2
Wheelbase	2,705	(106.5)

*1: Except for 20-inch wheel model

*2: For 20-inch wheel model

WHEN TRAVELLING OR REGISTERING IN ANOTHER COUNTRY

When planning to travel in another country or region, find out whether the fuel required for your vehicle is available in that country or region. Using a low octane rated fuel may cause engine damage. Therefore, be sure that the required fuel is available wherever you go. For additional information regarding recommended fuel, see earlier in this section.

When transferring the registration of your vehicle to another country, state, province or district, contact the appropriate authorities to find out that the vehicle complies with the local legal requirements. In some cases, a vehicle cannot meet the legal requirements, and it may be necessary to modify the vehicle to meet local laws and regulations. In addition, there may be possibilities that a vehicle cannot be adapted in certain areas.

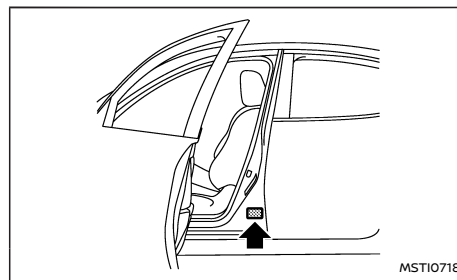
The laws and regulations for motor vehicle emission control and safety standards vary according to the country, state, province or district; therefore, the vehicle specification may differ.

When any vehicles are to be taken into another country, state, province or district, its modification, transportation, registration, and any other expenses which may result, are the responsibility of the user. NISSAN is not responsible for any inconveniences that may result.

VEHICLE IDENTIFICATION

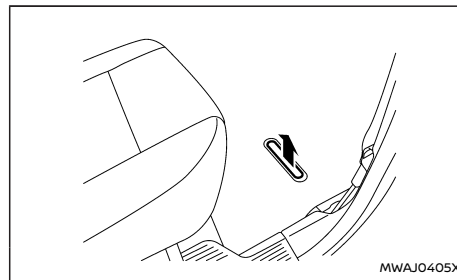
It is prohibited to cover, paint, weld, cut, drill, alter or remove Vehicle Identification Number (VIN).

VEHICLE IDENTIFICATION LABEL



The vehicle identification label is affixed as shown (on the driver's side).

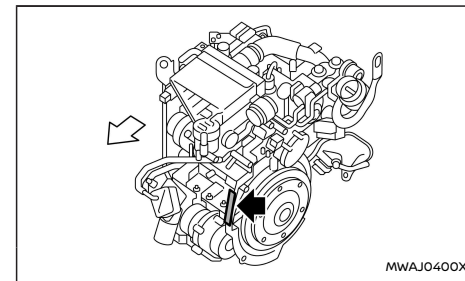
VEHICLE IDENTIFICATION NUMBER (VIN)



The vehicle identification number is located as shown.

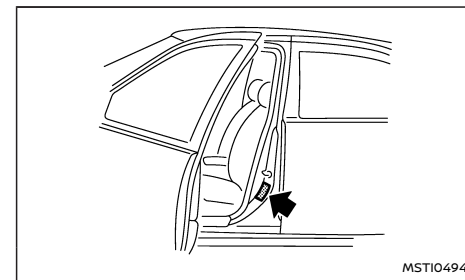
The surface is painted after stamping for rust prevention.

ENGINE SERIAL NUMBER



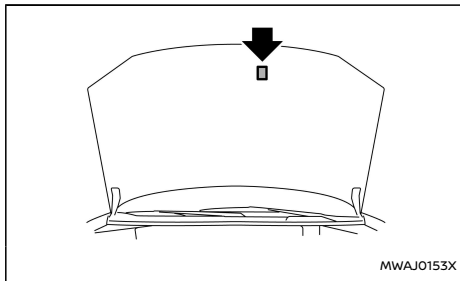
The engine serial numbers are located as shown.

TYRE PLACARD





The cold tyre pressures are shown on the tyre placard affixed to the driver's side centre pillar.

AIR CONDITIONER SPECIFICATION LABEL



The air conditioner specification label is attached to the underside of the bonnet as shown.

Air conditioner specification label symbols:		
Symbol Name	Reference	Graphic
Caution	ISO 7000 0434	
Air Conditioning System (MAC: Mobile air conditioning system)	ISO 2575 D01	
MAC System Lubricant Type (PAG- POE)		

Requires Registered Technician to Service MAC System		
Flammable Refrigerant		

INSTALLATION OF AN RF-TRANSMITTER

For countries conforming to UN regulation No.10 or equivalent:

The installation of an RF transmitter in your vehicle could affect electric equipment systems. Be sure to check with your NISSAN dealer or qualified workshop for precautionary measures or special instructions regarding installation. Upon request, your NISSAN dealer or qualified workshop will provide the detailed information (frequency band, power, antenna position, installation guide, etc.) regarding installation.

EVENT DATA RECORDERS (EDR) (where fitted)

This vehicle is equipped with an Event Data Recorder (EDR). The main purpose of an EDR is to record, in certain crash or near crash-like situations, such as an air bag deployment or hitting a road obstacle, data that will assist in understanding how a vehicle's systems performed. The EDR is designed to record data related to vehicle dynamics and safety systems for a short period of time, typically 30 seconds or less. The EDR in this vehicle is designed to record such data as:

- How various systems in your vehicle were operating;
- Whether or not the driver and passenger safety belts were buckled/fastened;
- How far (if at all) the driver was depressing the accelerator and/or brake pedal; and,
- How fast the vehicle was travelling.
- Sounds are not recorded.

These data can help provide a better understanding of the circumstances in which crashes and injuries occur.

NOTE: EDR data are recorded by your vehicle only if a nontrivial crash situation occurs; no data are recorded by the EDR under normal driving conditions and no personal data (e.g. name, gender, age and crash location) are recorded. However, other parties, such as law enforcement, could combine the EDR data with the type of personally identifying data routinely acquired during a crash investigation.

EDR data will only be accessed with the consent of the vehicle owner or lessee or as otherwise required or permitted by law.

ADDITIONAL DATA RECORDING (on vehicles equipped with optional ProPILOT Assist)

If your vehicle is equipped with the optional ProPILOT Assist, it will also be equipped with supplemental data recording function intended to assist in understanding how ProPILOT Assist performs in certain non-trivial crash or near-crash scenarios. Specifically, supplemental recording is designed to capture the following:

- Driver operational status of the accelerator, brakes, steering, etc.
- Detection status of a vehicle ahead and lane markers
- Vehicle information including distance to vehicle ahead and lateral position
- Information on the operation of the ProPILOT Assist and other crash avoidance features
- ProPILOT Assist malfunction diagnosis information
- External images from the multi-sensing front camera (Available only when the SRS air bag or Intelligent Emergency Braking system is activated)

The ProPILOT Assist does not record conversations, sounds or images of the inside of the vehicle.

To read this supplemental data, special equipment is required and access to the vehicle or the recording unit is needed. This supplemental data will only be accessed with the consent of the vehicle owner or lessee or as otherwise required or permitted by law. If downloaded, NISSAN and third parties entrusted by NISSAN may use the data recorded for the purpose of improving NISSAN's vehicle safety performance.

NISSAN and third parties entrusted by NISSAN will

ADDITIONAL DATA RECORDING (on vehicles equipped with TSR system)

not disclose/provide the recorded data to a third party except:

- With the consent of the vehicle owner or with the consent of the lessee
- In response to an official request from law enforcement, court order, governmental agency, or other legally enforceable request
- For research purposes after the data is modified such that it is no longer tied to a specific vehicle or vehicle owner (anonymised)

The TSR system is equipped with usage record collection capability that is required by regulations. It is designed to record the data of driving time and distance with the TSR operation.

The collected data will be accessed with the consent of the vehicle owner when the vehicle is garaged in a dealer. Then the collected data will be converted to statistical information which does not enable the identification of the specific individual, and be submitted only to the European Commission.

RADIO APPROVAL NUMBER AND INFORMATION

FOR EUROPE

Radio frequency approval

All radio frequency products fitted to the vehicle range during production conform to the requirements of the Radio Equipment Directive (RED) 2014/53/EU.

The countries covered by this directive, or those which accept it, are: Albania, Austria, Belgium, Bosnia & Herzegovina, Bulgaria, Croatia, Cyprus, Czech Republic, Denmark, Estonia, Finland, France, French Guiana, Georgia, Germany, Greece, Guadeloupe, Hungary, Iceland, Ireland, Italy, Kosovo, Latvia, Liechtenstein, Lithuania, Luxembourg, Macedonia, Malta, Martinique, Mayotte, Monaco, Montenegro, Netherlands, Norway, Poland, Portugal, Reunion, Romania, Saint Pierre & Miquelon, San Marino, Slovakia, Slovenia, Spain, Sweden, Switzerland, Turkey, Tuvalu, United Kingdom.

VEHICLE RADIO FUNCTIONS		
Frequency Range	Technology	Power/Magnetic Field
125 kHz (119 – 135 kHz)	Remote Keyless Entry Transponder Ring	≤ 42 dBμA/m at 10m
433 MHz (433.05 – 434.79 MHz)	Tyre Pressure Monitoring	≤ 10 mW e.i.r.p.
433.92 MHz (433.05 – 434.79 MHz)	Remote Keyless Entry	≤ 10 mW e.i.r.p.
20 kHz (9 – 90 kHz)	Keyless Go system	≤ 72 dBμA/m at 10m
2.4 GHz (2400 – 2483.5 MHz)	Bluetooth®, Wi-Fi	≤ 100 mW e.i.r.p.
824 – 894 MHz	GSM 850 (2G)	≤ 39 dBm e.i.r.p.
880 – 960 MHz	GSM 900 (2G)	≤ 39 dBm e.i.r.p.
1710 – 1880 MHz	GSM 1800 (2G)	≤ 36 dBm e.i.r.p.
1850 – 1890 MHz	GSM 1900 (2G)	≤ 33 dBm e.i.r.p.
1922 – 2168 MHz	W-CDMA Band I (3G)	≤ 24 dBm e.i.r.p.
24.05 – 24.25 GHz	24 GHz ISM Radar	≤ 100 mW e.i.r.p.
24.25 – 26.65 GHz	24 GHz UWB Radar	≤ -41,3 dBm/MHz e.i.r.p. mean ≤ 0 dBm/50 MHz e.i.r.p. peak
76 – 77 GHz	77 GHz Radar	≤ 55 dBm e.i.r.p.

Tyre Pressure Monitoring System (TPMS) transmitter

Hereby, Continental declares that the radio equipment type TIS-09DL is in compliance with Directive 2014/53/EU.

The full text of the EU declaration of conformity is available at the following internet address:

<https://continental-homologation.com/en-gl/Nissan>

- Manufacturer name, Address
Continental Automotive GmbH
Siemensstrasse 12, D-93055 Regensburg, Germany
- Importer name, Address
NISSAN AUTOMOTIVE EUROPE S.A.S.
8 Rue Jean Pierre Timbaud, 78180 Montigny-le-Bretonneux FRANCE
- Frequency band: 433.92 MHz
- Maximum transmitter power: -17 dBm

Front radar sensor (where fitted)

Simplified EU declaration of conformity

Hereby, Robert Bosch GmbH declares that the radio equipment type FR5CPEC/F5CP32 is in compliance with Directive 2014/53/EU. The full text of the EU declaration of conformity is available at the following internet address:

<http://eu-doc.bosch.com>



Side radar sensor (where fitted)

Simplified EU declaration of conformity	<p>Hereby, Aptiv Services Deutschland GmbH declares that the radio equipment type 6TR is in compliance with the essential requirements and other relevant provisions of Directive 2014/53/EU (RED).</p> <p>The full text of the EU declaration of conformity is available at the following internet address: www.aptiv.com/ automotive-homologation</p> <p>Frequency band(s) in which the radio equipment operates: 76-77 GHz</p> <p>Maximum radio-frequency power transmitted in the frequency band(s) in which the radio equipment operates: 30 dBm (1 W)</p>
---	---



Intelligent Key

Hereby, Continental declares that the radio equipment type TXPZ1 is in compliance with Directive 2014/53/EU & UKCA requirement. The full text of the EU & UKCA declaration of conformity is available at the following internet address:

<https://continental-homologation.com/en-gl/Nissan>

Intended use: Remote key fob

Manufacturer:

Continental Automotive GmbH

Siemensstrasse 12

93055 Regensburg

Germany

Frequency band: 433.92 MHz

Maximum transmitter power: -12 dBm



Hands-Free Module (where fitted)

Hereby, Continental declares that the radio equipment type HFM401 is in compliance with Directive 2014/53/EU & UKCA requirement. The full text of the EU & UKCA declaration of conformity is available at the following internet address:

<https://continental-homologation.com/en-gl/Nissan>

Manufacturer:

Continental Automotive GmbH

Siemensstrasse 12

93055 Regensburg

Germany

- Operating frequency band: 433.92 MHz.

BCM (Body Control Module)

Hereby, Continental declares that the radio equipment type 40406557 is in compliance with Directive 2014/53/EU & UKCA requirement. The full text of the EU & UKCA declaration of conformity is available at the following internet address:

<https://continental-homologation.com/en-gl/Nissan>

Manufacturer:

Continental Automotive GmbH

Siemensstrasse 12

93055 Regensburg

Germany

FOR UKRAINE

Tyre Pressure Monitoring System (TPMS) transmitter

Справжнім Continental Automotive GmbH заявляє, що тип радіообладнання TIS-09DL відповідає Технічному регламенту радіотехнічного обладнання; Повний текст декларації про відповідність доступний на веб-сайті за такою адресою:

<https://continental-homologation.com/en-gl/Nissan>

Частотний діапазон: [433.92 MHz]
Максимальна потужність передавача: [<10 mW]

Continental Automotive GmbH
Siemensstrasse 12
93055 Regensburg
Germany



MWAJO445X

Front radar sensor (where fitted)



UA RF: 1BOSC0001

MWAJO414X



UA RF: 1BOSC0012

MWAJO584X

справжнім (Robert Bosch GmbH) заявляє, що тип радіообладнання (FR5CPEC) відповідає Технічному регламенту радіообладнання; повний текст декларації про відповідність доступний на веб-сайті за такою адресою:
<http://ita.bosch.com/radar>

English translation of the above Ukrainian text:
The present (Robert Bosch GmbH) states that the type of radio equipment (FR5CPEC) corresponds to the Technical regulations of the radio equipment;
The full text of the declaration of conformity is available on the website at the following address:
<http://ita.bosch.com/radar>

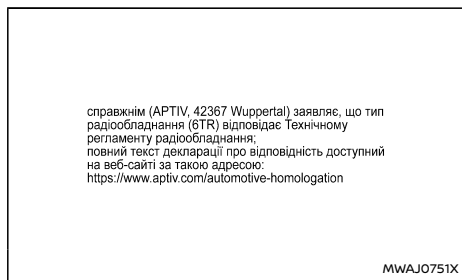
MWAJO415X

справжнім (Robert Bosch GmbH) заявляє, що тип радіообладнання (F5CP32) відповідає Технічному регламенту радіообладнання; повний текст декларації про відповідність доступний на веб-сайті за такою адресою:
<http://ita.bosch.com/radar>

English translation of the above Ukrainian text:
The present (Robert Bosch GmbH) states that the type of radio equipment (F5CP32) corresponds to the Technical regulations of the radio equipment;
The full text of the declaration of conformity is available on the website at the following address:
<http://ita.bosch.com/radar>

MWAJO586X

Side radar sensor (where fitted)



ISA box (where fitted)

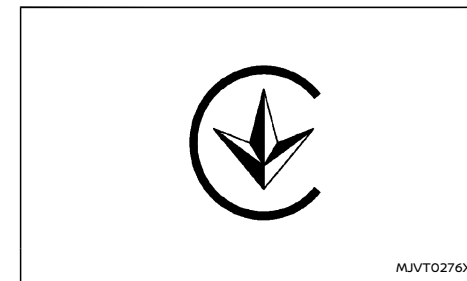
Цим VALEO Telematik und Akustik GmbH заявляє, що тип радіобладнання: Головний блок з технологією GSM, UMTS, LTE, GNSS. Модель: A-IVC-EU-01 відповідає Технічному регламенту радіобладнання; повний текст декларації про відповідність доступний на веб-сайті за такою адресою:

<https://www.valeo-clientportal.com>

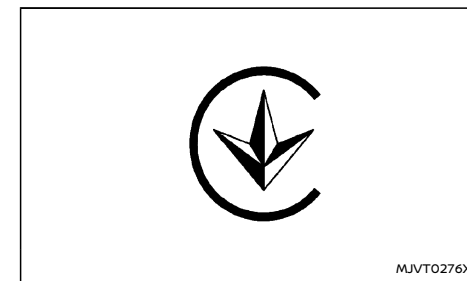
E-GSM/GSM-900/GSM1800	880,1 – 915 / 925,1 – 960 МГц 1710 – 1785 / 1805 – 1880 МГц	33 дБм (GSM-900) 30 дБм (GSM-1800)
UMT-2000 (UMTS)	1920-1980 / 2110 – 2170 МГц (Band I) 888,8 – 906 / 933,8 – 951 МГц (Band VIII)	24 дБм
E-UTRA Band 3	1710 – 1785 / 1805 – 1880 МГц	23 дБм
E-UTRA Band 5	827,8 – 834 / 872,8 – 879 МГц	23 дБм
E-UTRA Band 7	2510 – 2545 / 2630 – 3665 МГц 2565 – 2570 / 2685 – 2690 МГц	23 дБм
E-UTRA Band 8	888,8 – 906 / 933,8 – 951 МГц	23 дБм
E-UTRA Band 20	832 – 842 / 791 – 801 МГц	23 дБм

MWAJ0749X

BCM (Body Control Module)



Hands-Free Module (where fitted)



Intelligent Key

Справжнім Continental заявляє, що тип радіобладнання
ТХРZ1/ТХРZ3 відповідає Технічному регламенту
радіотехнічного обладнання;
Повний текст декларації про відповідність доступний на
веб-сайті за такою адресою:
<http://continental-homologation.com/nissan>
Частотний діапазон: [433,92MHz]
Максимальна потужність передавача: [-15dBm]
Continental Automotive GmbH
Siemensstrasse 12
93055 Regensburg Germany

MWAJO496X

FOR THE UNITED KINGDOM



Description	Supplier	Supplier Address	UKCA Certificate #	Link to Certificate	Importer	Importer Address
Intelligent Key Model TXPZ1	Continental Automotive GmbH	Siemensstrasse 12, D-93055 Regensburg, Germany	Refer to Link	https://continental-homologation.com/en-gl/Nissan	Nissan Motors Great Britain (NMGB)	Rivers Office Park Denham Way Rickmansworth WD3 9YS
Hand Free Module Model HFM401	Continental Automotive GmbH	Siemensstrasse 12, D-93055 Regensburg, Germany	Refer to Link	https://continental-homologation.com/en-gl/Nissan		
Telematics Control Unit (TCU) Model A-IVCEU- 01	VALEO Telematik und Akustik GmbH	Max-Planck-Strasse 28-32, 61381 Friedrichsdorf/Ts Germany	Refer to Link	https://www.valeo.com/declaration-of-conformity		
Body Control Module (BCM) Model 40406557	Continental Automotive GmbH	Siemensstrasse 12, D-93055 Regensburg, Germany	Refer to Link	https://continental-homologation.com/en-gl/Nissan		
Tyre Pressure Monitoring System (TPMS) sensor Model TIS- 09DL	Continental Automotive GmbH	Siemensstrasse 12, D-93055 Regensburg, Germany	Refer to Link	https://continental-homologation.com/en-gl/Nissan		
Front radar sensor FR5CPEC/ F5CP32	Robert Bosch GmbH	PO Box 1661 71226, Leonberg	Refer to Link	https://ita.bosch.com		
Side radar sensor Model 6TR	Aptiv Services Deutschland GmbH	Am Technologiepark 1 D-42119 Wuppertal Germany	Refer to Link	https://www.aptiv.com/en/automotive-homologation		
AIVI Model AIVI-P33A0	Robert Bosch GmbH	Postfach 31132 Hildesheim Germany	Refer to Link	https://doc-ita.bosch.com/search.html?r=GB&p=0&q=AIVIP33A0		
AIVI Model AIVI2SBXM	Robert Bosch GmbH	Postfach 31132 Hildesheim Germany	Refer to Link	https://gb-doc.bosch.com		

Description	Supplier	Supplier Address	UKCA Certificate #	DECLARATION OF CONFORMITY	Importer	Importer Address
Audio system	Yanfeng Visteon Automotive Electronics Co., Ltd.	No.300,Minolta Road Songjiang District shanghai 201600, P.R.China.	TUVS19- UK/17 SEP 2021/Rev A	<p>Certification ID:TUVS19-UK/17 SEP 2021/Rev A</p> <p>Satisfies all the technical regulations applicable to the product within the scope of UK Radio Equipment Regulations (SI 2017/1206); UK Electrical Equipment (Safety) Regulations (SI 2016/1101); and UK Electromagnetic Compatibility Regulations (SI 2016/1091) and declare that the same application has not been lodged with any other UK Approved Body.</p> <p>Bluetooth frequency band(s) in which the radio equipment operates: 2402-2480 MHz</p> <p>Maximum radio-frequency power transmitted in the frequency band(s) in which the radio equipment operates: Bluetooth < 5.86 dBm (EIRP)</p>	Nissan Motors Great Britain (NMGB)	Rivers Office Park Denham Way Rickmansworth WD3 9YS

FOR TURKEY

Front radar sensor (where fitted)

Manufacturer:

Robert Bosch GmbH

Posta kutusu 1661

71226 Leonberg, Almanya

10 Regulatory Information

Environmental information	476	Consumer and user safety	
Environmental concern	476	information (REACH)	476
Compliance at every step	476	Protect the environment when driving	476
We build our vehicles with recycling in mind	476	AIRBAG LABEL (where fitted)	478

ENVIRONMENTAL INFORMATION

ENVIRONMENTAL CONCERN

Today, the efforts made by NISSAN to fulfil our responsibilities to protect and sustain the environment are far-reaching. Within NISSAN, we promote the highest levels of practice in every region and in every area of operations.

COMPLIANCE AT EVERY STEP

NISSAN focuses on ensuring that end of life vehicle components are reused, recycled or recovered, and guarantees compliance with EU legislation (the End of Life Vehicle Directive).

WE BUILD OUR VEHICLES WITH RECYCLING IN MIND

Reducing landfill waste, emissions, conserving natural resources, and enhancing recycling activities are emphasised daily in our manufacturing, sales and service operations and in the disposal of end of life vehicles (ELV).

Design phase

To reduce environmental impact we have developed your NISSAN vehicle to be 95% recoverable. We mark the components to facilitate dismantling, recycling and to reduce hazardous substances. We carefully verify and control substances of concern. We have already reduced to a minimum the cadmium, mercury and lead in your NISSAN vehicle. NISSAN includes recycled material in your vehicle and looks for opportunities to increase the percentage of recycled materials used.

Manufacturing phase

NISSAN plants based in the UK already achieve a recycling rate of over 90% and are looking for further improvements. The UK plant installed 10 wind turbines to cut carbon dioxide emissions at power plants by more than 3,000 tonnes per year.

Production and distribution phase

Using resources efficiently to reduce the amount of waste generated during the production and distribution stage. NISSAN promotes activities based on Reducing, Reusing, and Recycling materials whenever possible. NISSAN's goal is to achieve a 100% recycling rate for operations in Japan and globally.

Use and service phase

NISSAN dealers are our window to you, our customer. In order to meet your expectations they provide not only high quality services but are also environmentally responsible. NISSAN promotes activities to recycle the waste generated as a result of service centre activities.

Disposal phase

Recycle your end of life vehicle or its components. When your NISSAN reaches the end of its life, and is no longer suitable for daily use, it still has value. You can help prevent waste affecting the environment by bringing your NISSAN to be recycled at our collection networks in your area. Our collection networks guarantee no cost for the treatment of your ELV. For further information on how and where to dispose of your ELV refer to your local

NISSAN dealer or consult: www.nissan-europe.com.

CONSUMER AND USER SAFETY INFORMATION (REACH)

REACH is the chemical regulation in the EU, focusing on Registration, Evaluation, Authorisation and Restriction of Chemicals manufactured in or imported into the European Economic Area.

Nissan complies with REACH obligations, and fully supports its underlying goals: to protect human health and reduce the environment from risks posed by chemicals.

For more information, visit www.nissan-safety-sheets.com

This website provides information on substances present in the Nissan product(s) that you buy, and recommendations for their safe use.

PROTECT THE ENVIRONMENT WHEN DRIVING

Your driving behaviour has significant impact on fuel economy and the environment. Follow the tips below for better fuel-efficiency, better driving habits, and to be environmentally friendly by reducing emissions:

Fuel efficient driving

Anticipating traffic conditions and acting accordingly reduces fuel consumption, helping to protect of our natural environment. Take your foot off the accelerator while approaching traffic lights and avoid last minute braking when the light turns red.

Avoid speeding, harsh acceleration, and strong braking. The gain in time does not offset pollution of the environment. Try to maintain speed when

driving uphill to reduce fuel consumption and pollution. Maintain speed or allow the vehicle to go slower where traffic allows.

Close windows when driving

Driving with a window open at 100 km/h (62 MPH) increases fuel consumption by up to 4%. Driving with the windows closed allows for better fuel economy.

Use the roof rack only when necessary

Only install the roof luggage system when you really need it, otherwise put it inside the vehicle or store it in your garage. Do not drive around with an empty roof rack, kayak holder, or ski rack, this will reduce your aerodynamic drag significantly.

Optimise the use of air conditioning

The air conditioning system has a positive effect on driving and vehicle safety through comfort cooling and dehumidifying, drivers are more alert and have better visibility when window demisting/defogging becomes necessary. However, use of the air conditioning system will increase fuel consumption substantially in an urban environment. Optimise the use of air conditioning by using the vents as much as possible.

Use the parking brake on slopes

Use the parking brake when holding your vehicle on a slope. Avoid using the accelerator to hold your vehicle as this leads to unnecessary fuel consumption and wear.

Maintain a safe distance

Anticipate traffic conditions for a smoother drive and to assure comfort and safety during your trip. Drive and maintain a safe distance from other vehicles while in traffic. This will help reduce fuel consumption as you will not be constantly tapping your brakes.

Check your tyre pressure

Low tyre pressure increases fuel consumption as well as the use of non-recommended tyres. Correct tyre pressure will maximise the grip of your vehicle and optimise fuel consumption.

Have your car serviced regularly

Regular service allows you to run your vehicle in optimal condition and with the best fuel efficiency. Have your vehicle serviced by your NISSAN dealer or a qualified workshop to ensure that it is maintained to its original standard.

AIRBAG LABEL (where fitted)



NEVER use a rearward facing child restraint on a seat protected by an ACTIVE AIRBAG in front of it, DEATH or SERIOUS INJURY to the CHILD can occur.

NE JAMAIS utiliser un dispositif de retenue pour enfant de type dos à la route sur un siège protégé par un AIRBAG ACTIVÉ placé devant lui. Cela peut entraîner la MORT de l'ENFANT ou des BLESSURES GRAVES.

Installieren Sie niemals ein entgegen der Fahrtrichtung angeordnetes Kinderrückhaltesystem auf einem Stz mit aktiviertem Frontairbag. Es könnte zum Tod oder schweren Verletzungen des Kindes führen.

No instalar nunca los sistemas de retención para niños (sillitas de niño) de espaldas al sentido de la marcha en el asiento del pasajero protegido por un AIRBAG frontal ACTIVO. Esto puede provocar la MUERTE del niño o DAÑARLE SERIAMENTE.

«NON INSTALLARE MAI un seggiolino per bambini rivolto con verso opposto al senso di marcia su un sedile protetto da un AIRBAG frontale ATTIVO. In caso di incidente questo potrebbe risultare molto pericoloso per l'incolumità del bambino.»

Plaats nooit een kinderzitje achterstevoren op de passagiersstoel voorin als de airbags van de voorpassagier niet zijn uitgeschakeld. Dit kan ernstige of zelfs dodelijke verwondingen van het kind veroorzaken.

NUNCA utilize um sistema de retenção de criança virado para a traseira num banco protegido por um AIRBAG ACTIVO à sua frente, porque pode ocorrer MORTE ou FERIMENTOS GRAVES na CRIANÇA.

W żadnym przypadku NIE NALEŻY stosować fotelików dla dzieci skierowanych twarzą do tyłu przed siedzeniami chronionymi AKTYWNA PODUSZKA POWIETRZNA. Może to doprowadzić do POWAŻNYCH OBRAŻEŃ lub nawet ŚMIERCI DZIECKA.

NIKDY nepoužívejte dětskou sedačku směřující dozadu na sedadle s AKTIVNÍM čelním AIRBAGEM, mohlo by dojít k USMRCENÍ nebo VÁŽNĚMU ZRANĚNÍ DÍTĚTE.

Önünde AKTIF BİR HAVA YASTIĞI ile korununan bir koltuğa hiç bir zaman yüzü geriye bakan bir çocuk koltuğu KOYMAYIN, bu ÇOCUĞUN ÖLÜMÜNE veya CİDDİ ŞEKİLDE YARALANMASINA neden olabilir.

Nu folosiți NICIODATĂ un scaun pentru copil cu spatele la direcția de deplasare pe un scaun protejat de un AIRBAG ACTIV amplasat în fața sa, deoarece există riscul de DECES sau RĂNIRE GRAVĂ a copilului.

SOHA ne használnjon hátrafelé néző gyermekülést olyan ülésen, amelyet előlről AKTÍV LÉGZSÁK véd, mert az a GYERMEK HALÁLÁT vagy SÚLYOS SÉRÜLÉSÉT okozhatja.

“ΑΠΑΓΟΡΕΥΕΤΑΙ η τοποθέτηση παιδικού καθίσματος, με την πλάτη προς το εμπρόσθιο μέρος του αυτοκινήτου, στο κάθισμα του συνοδηγού, επειδή μπροστά του υπάρχει ΕΝΕΡΓΟΣ ΜΕΤΩΠΙΚΟΣ ΑΕΡΟΣΑΚΟΣ. Μπορεί να επέλθει, ΘΑΝΑΤΟΣ ή ΣΟΒΑΡΟΣ ΤΡΑΥΜΑΤΙΣΜΟΣ του ΠΑΙΔΙΟΥ”.

Använd ALDRIG en bakåtvänd barnstol på ett säte som skyddas av en AKTIVERAD AIRBAG framför det; LIVSFARA eller risk för ALLVARLIGA SKADOR.

ÄLÄ KOSKAAN käyttää kasvot taaksepäin suunnattua lastenistuinta istuimella, jossa on KÄYTÖSSÄ OLEVA TURVATYNNY. Seurauksena voi olla KUOLEMA tai LAPSEN VAKAVA LOUKKAANTUMINEN.

Brug ALDRIG et bagudvendt barnesæde på et sæde, der er beskyttet af en AKTIV AIRBAG foran det. Det kan resultere i DØD eller ALVORLIG PERSONSKADE på BARNET.

MNSY1042



NEMOJTE upotrebljavati sjedalicu za djecu okrenutu prema natrag na sjedalu ispred kojega se nalazi zaštićeni AKTIVNI ZRAČNI JASTUK, može doći do SMRTONOSNIH ili OZBILJNIH OZLJEDA za DIJETE.

NIKOLI ne namestite otroškoga sedeaža, obrnjenoga v nasprotni smeri smeri vožnje, v primeru VKLOPLJENE varnostne blazine. To lahko povzroči OTROKOVO SMRT ali HUDE TELESNE POŠKODBE.

Никогда не устанавливайте обращенное назад детское удерживающее сиденье на переднем пассажирском сиденье при неотключенной подушке безопасности. Это может привести к смерти ребенка или к тяжелым повреждениям.

NIKDY nepoužívajte detskú sedačku smerujúcu dozadu na sedadle s AKTÍVNYM čelným AIRBAGOM, mohlo by prísť k USMRTENIU alebo VÁŽNEMU ZRANENIU DIEŤAŤA.

ÄRGE kasutage seljaga sõidusuunas laste turvatooli istmel, mille ees on AKTIIVNE TURVAPADI. LAPS võib saada TÕSISE KEHAVIGASTUSE või HUKKUDA.

NEIEVIETOJĪET ar skatu pretēji braukšanas virzienam vērstu bērnu sēdekļi šajā sēdekļi, ja tā priekšā uzstādītais GAISA SPILVENS ir AKTIVIZĒTS, – tas BĒRNAM var radīt NOPIETNAS TRAUMAS vai pat izraisīt BĒRNA NĀVI.

NUNCA utilize uma cadeirinha protetora para crianças voltada para a traseira em um assento que seja protegido por um AIR BAG ATIVO na frente do assento. Podem ocorrer MORTE ou FERIME NTOS GRAVES para a CRIANÇA.

NIEKADA nevežkite vaiku prie automobīlio sēdynēs atvirkščiai judējimo kryptīai pritvirtinotje specialioje kėdutėje, jeigu ši sėdynė apsaugota VEIKIANČIA SAUGOS PAGALVE, nes VAIKUI kyla MIRTINAS ar SUNKAUS SUŽEIDIMO pavojus.

Ніколи не встановлюйте дитяче крісло спинною вперед на сидінні, передня ПОДУШКА БЕЗПЕКИ якого не заблокована. Ризик ЗАГИБЕЛІ або ТЯЖКИХ ТРАВМ дитини.

„Никога на използвайте детско столче за автомобил, монтирано с гръб към движението, на седалка оборудвана с предпазна въздушна възглавница пред нея. Съществува риск за живота или сериозно нараняване на детето!“

يحذر نهائيًا تثبيت مقعد الطفل بشكل عكسي على القعد المحمي بوسادة هوائية نشطة أمام مقعد الطفل، فمن الممكن أن يتسبب ذلك في وفاة الطفل أو إصابته بجروح خطيرة

ALDREI má nota festingar sem snúa afturábak á sæti sem varið er með ACTIVE AIRBAG að framan. Það getur valdið DAUÐA eða ALVARLEGUM MEIDLUM á BARNINU.

Na sedež, ki je spredaj zaščiten z ZRAČNO BLAZINO, NIKOLI ne namestite otroškega sedeža tako, da otrok gleda nazaj: nevarnost SMRTI ali RESNE TELESNE POŠKODBE OTROKA

هرگز از کمربند کودک رو به پشت در روبروی صندلی حفاظت شده توسط ACTIVE AIRBAG (کیسه هوای فعال) استفاده نکنید. این کار ممکن است باعث مرگ یا جراحت شدید در کودک شود.

절대로 능동형 에어백이 전면에 설치된 좌석에 후향식 어린이 보호시트를 사용하지 마십시오. 어린이에게 심각한 상해를 입히거나 사망에 이르게 할 수 있습니다.

前部に作動可能なエアバッグが装着されているシートに、後ろ向きのチャイルドシートを絶対に使用しないでください。お子様に死や大けがを招く恐れがあります。

禁止在座椅前部安全气囊激活的情况下，在该座椅上使用后向儿童安全座椅，可能造成儿童严重受伤甚至死亡。

MNSY1043

MEMO

11 Index

Number	
12-volt battery	437
- Variable voltage control system	440
4WD	244

A	
ABS (Anti-lock Braking System)	370
Active noise cancellation	399
Active sound enhancement	399
Adaptive LED headlight	123
Adjustable luggage floor	143
Air bag system	
- Air bag warning labels	60
- Air bag warning light	61
- Supplemental curtain side-impact air bag system	57, 68
- Supplemental front central side-impact air bag system	57
- Supplemental front-impact air bag system	57, 63
- Supplemental side-impact air bag system	57, 67
Air bag warning light	88
Air cleaner housing filter	435
Air conditioner	
- Air conditioner operation	220
- Air conditioner service	223
- Air conditioner specification label	462
- Air conditioning system refrigerant and lubricant recommendations	223

Alert	
- Rear Door Alert	133
Anti-lock Braking System (ABS)	370
Anti-lock Braking System (ABS) warning light	84
Appearance care	
- Exterior appearance care	416
- Interior appearance care	418
Approach unlock function	164
Approaching Vehicle Sound for Pedestrians (VSP) system	12
Armrest	34
Assist grips	151
Audible reminders	91
Audio	
- NissanConnect	194
Automatic air conditioner and heater	221
Automatic brake hold	191
Automatic sunroof and sunshade	148
Average fuel consumption	115
Average speed	115

B	
Back door	174
- Auto closure	177
- Back door release lever	178
- Operating manual back door	174
- Operating power back door	174
Battery	425
- Battery replacement, Intelligent Key	439
- Battery saver system	122

- Intelligent Key battery discharge	237
- Lithium ion (Li-ion) battery	3
Before starting e-POWER system	229
Before using emergency tyre puncture repair kit	404
Blind Spot Warning (BSW)	270
Blocking wheels	451
Bonnet release	173
Brake	
- Anti-lock Braking System (ABS)	370
- Brake fluid	434
- Brake system	369
- Brake system warning light (yellow)	84
- Parking brake	189
- Regenerative brake	3
- Warning light	85
Brightness control	
- Instrument panel	81
Bulb check/instrument panel	84
Bulb replacement	423, 443

C	
Car phone or CB radio	224
Card holder	141
Care when driving	235
Cargo light	152
Catalytic converter, Three-way catalyst	230
Changing inverter coolant	429
Changing tyres and wheels	449
Charger	
- USB (Universal Serial Bus) charging connector	135

- Wireless charger	135	- Cruise control (without ProPILOT Assist) (See	e-POWER system	2
Chassis control	374	Conventional (fixed speed) cruise	- e-POWER system precautions	5
Checking inverter coolant level	429	control mode)	- e-POWER system start	
Checking parking brake	433	293, 319	operation indicator	104
Child restraints	43	CRUISE Navi Link (ProPILOT Assist	- e-POWER system warning light	86
Child safety	40	with Navi-link)	- Emergency e-POWER system shut off	403
Child safety rear door lock	159	326	ECO mode	239
Chimes		Cup holders	ECO mode system	
- Seat belt warning light and chime	88	139	- ECO Drive Report	82
Chimes, Audible reminders	91		Economy, Fuel	364
Circuit breaker, Fusible link	441	D	Efficient use of your vehicle	8
Cleaning exterior and interior	416, 418	Daytime Running Lights (DRL) system	Elapsed time	115
Clock	117	Defogger switch	Electric power steering	369
Coat hook	142	Dimensions	Electric power steering warning light	86
Cold weather driving	397	Display	Electric shift control system	240
Console box	141	- Head Up Display (HUD)	Electric shift control system warning light	86
Conventional (fixed speed) cruise control mode		- Vehicle information display	Emergency Lane Assist (ELA) system	263
(with ProPILOT Assist)	336	92	Emergency services call eCall/SOS system	137
Conventional (fixed speed) cruise control mode		Drive belt	Emergency shut-off system	8
(without ProPILOT Assist)	306	Drive Computer	Emergency Stop Signal	402
Coolant		Drive Mode Selector	Emergency tyre puncture repair kit	403, 453
- Changing engine coolant	428	Driver Assistance systems	Energy Flow	115
- Checking engine coolant level	428	- Common troubleshooting guide	Engine	
- High Coolant Temp warning	113	250	- Changing engine coolant	428
Corrosion protection	420	Driving	- Changing engine oil and filter	430
Coupling device installation (for Europe)	368	- Care when driving	- Checking engine coolant level	428
Cover, Tonneau cover	142	- Cold weather driving	- Checking engine oil level	430
Cruise control		- Drive Mode Selector	- Engine compartment check locations	427
- Conventional (fixed speed) cruise		- Driving in wet conditions	- Engine cooling system	428
control mode	306, 336	- Driving in winter conditions	- Engine oil	430
- Cruise control (with ProPILOT Assist) (See Con-		- On-pavement and off-road driving	- Engine serial number	461
ventional (fixed speed) cruise		- Precautions when starting and driving	- Engine specifications	459
control mode)	336	- Safety precautions	- If your vehicle overheats	409
- Cruise control (without ProPILOT		233	EV mode	11
Assist)	291		Event Data Recorders (EDR)	464
		E		
		e-Pedal indicator		
		e-Pedal Step system		

Exhaust filter, Petrol Particulate Filter (GPF)	230
Exhaust gas (carbon monoxide)	229
Explanation of general maintenance items	423

F

Filter	
- Air cleaner housing filter	435
- Changing engine oil and filter	430
Flashers (See hazard warning flasher switch)	402
Flat tyre	403
Floor mat cleaning	419
Fluid	
- Brake fluid	434
- Engine coolant	428
- Engine oil	430
- Gear fluid	434
- Inverter coolant	429
- Window washer fluid	425, 437
Fog light switch	128
Forward Driving Aids	245
Four-Wheel Drive (4WD)	244
Frequency approval numbers	466
Front seat, Front seat adjustment	26
Front-impact air bag system	63
Fuel	
- Fuel economy	364
- Fuel information	457
- Fuel octane rating	457
- Fuel-filler lid	178
- Gauge	81
Fuel Efficient Driving Tips	363
Fuses	440
Fusible links	441

G

Garage mode system	177
Gauge	78
- Fuel gauge	81
- Odometer	79
- Speedometer	79
Gear fluid	434
General maintenance	423
Glove box	140

H

Hazard indicator and outside chime	170
Hazard warning flasher switch	402
Head restraints	35
Head Up Display (HUD)	118
Headlight aiming control	125
Headlights	
- Bulb replacement	444
- Headlight switch	120
Heated seats	29, 32
Heated steering wheel switch	133
Heated windscreen	131
Heater	
- Heater and air conditioner operation	220
High beam assist	121
High Coolant Temp warning	113
Hill descent control switch	376
Hill descent control system	375
Hill start assist system	375
Hook	
- Coat hook	142
- Luggage hook	142
Horn	132

I

immobiliser system	172
Indicator	
- Lights	88
- Vehicle information display	92
Inside rearview mirror	181
Installing tyre	452
Instrument brightness control	81
Instrument panel	76
Intelligent Around View Monitor	207
Intelligent Around View Monitor detection condi- tions and limitations	395
Intelligent Blind Spot Intervention	276
Intelligent Cruise Control (ICC)	293, 319
Intelligent Driver Alertness	355
Intelligent Emergency Braking system OFF warning light	86
Intelligent Emergency Braking with Pedestrian Detection system	338
Intelligent Forward Collision Warning	348
Intelligent Key battery discharge	237
Intelligent Key button operation light	169
Intelligent Key system	160, 235
- Key operating range	161
- Remote keyless operation	168
Intelligent Rear View Mirror	181
Intelligent Trace Control	374
Interior light replacement	444
Interior light switch	151
Interior lights	151
Inverter cooling system	429
ISOFIX child restraint system	49

J			
Jacking up vehicle	449		
Jump starting	407		
K			
Key			
- Intelligent Key battery discharge	237		
- Intelligent Key system	235		
Keyless entry			
- With Intelligent Key system (See Intelligent Key system)	168		
Keys	156		
- For Intelligent Key system	160		
KR15DDT engine model	427		
L			
Labels			
- Air conditioner specification label	462		
- Engine serial number	461		
- Tyre placard	461		
- Vehicle identification label	461		
- Vehicle identification number (VIN)	461		
Legal requirement to adjust headlight beam	445		
Li-ion battery available charge gauge	80		
Light			
- Bulb replacement	423, 443		
- Cargo light	152		
- Fog light switch	128		
- Headlight switch	120		
- Headlights bulb replacement	444		
- Indicator lights	88		
- Interior lights	151		
- Map lights	152		
- Rear personal lights	152		
- Replacement	423		
- Room lights	152		
- Warning lights, indicator lights and audible reminders	84		
Lights, Exterior and interior light replacement	444		
Lithium ion (Li-ion) battery	3		
Lock			
- Door locks	157		
- Power door lock	157		
Low tyre pressure warning (Tyre Pressure Low)	105		
Low tyre pressure warning light	87		
Low tyre pressure warning system (See Tyre Pressure Monitoring System (TPMS))	231		
Lower console tray	141		
Luggage			
- Adjustable luggage floor	143		
Luggage hooks	142		
M			
Maintenance			
- 12-volt battery	425, 437		
- General maintenance	423		
- Maintenance precautions	425		
- Maintenance requirements	423		
- Seat belt maintenance	42		
Malfunction indicator light (MIL)	89		
Map lights	152		
Master warning light	88		
Mechanical key (Intelligent Key system)	157		
Memory seat	187		
Meters and gauges			
- Instrument brightness control	81		
Mirror			
- Inside rearview mirror	181		
- Intelligent Rear View Mirror	181		
- Outside rearview mirrors	186		
- Vanity mirror	187		
Moving Object Detection (MOD)	216		
N			
NATS (NISSAN Anti-Theft System)	172		
Neutral hold mode	243		
O			
Odometer	79		
OFF-ROAD mode	239		
Off-road recovery	233		
Oil			
- Changing engine oil and filter	430		
- Checking engine oil level	430		
- Engine oil	430		
Operating precautions	366		
Outside air temperature	117		
Outside rearview mirrors	186		
Overheat, If your vehicle overheats	409		
P			
P position switch	241		
Parking	364		
- Parking brake	189		
Parking Aids	245		
Parking brake			
- Electronic parking brake warning light	85		
Parking sensor			
- ProPILOT Park	381		

Parking sensor (sonar) detection conditions and limitations	395
Parking sensor (sonar) system	377
Petrol Particulate Filter (GPF)	230
Power	
- Electric power steering	369
- Power door lock	157
- Power outlet	134
- Power windows	146
Power limitation indicator light	90
Power meter	80
Power switch	235
- Power switch positions	236
Power switch positions	236
Pre-tensioner seat belt system	60, 68
Precautions	
- Braking precautions	369
- Driving safety	233
- e-POWER system	5
- Maintenance	425
- On-pavement and off-road driving	233
- Precautions on Supplemental Restraint System	57
- Seat belt usage	38
- When starting and driving	229
Preparing tools	450
ProPILOT Assist	309
- ProPILOT Park	381
ProPILOT Assist with Navi-link	
- CRUISE Navi Link	326
- Speed Limit Link	324
ProPILOT Park	381
ProPILOT Park detection conditions and limitations	396
Push starting	409
Push-button power switch	235

R

RAB system	358
Radio	
- NissanConnect	194
READY to drive indicator light	90
Rear Automatic Braking (RAB)	358
Rear Automatic Braking (RAB) system OFF warning light	88
Rear Cross Traffic Alert (RCTA)	284
Rear Door Alert	133
Rear door lock, Child safety rear door lock	159
Rear Driving Aids	245
Rear personal lights	152
Rear sunshade	151
Rear view monitor	201
Rear window wiper and washer switch	130
Recommended Fluids/lubricants and capacities	456
Recommended SAE viscosity number	457
Recorders, Event data	464
Regenerative brake	3
Remote keyless entry function, For Intelligent Key system	168
Removing tyre	451
Repairing flat tyre	403
Replacing tyres	449
Road accident cautions	7
Roof rack	145
Room lights	152

S

Safety chains	366
Safety, Child seat belts	40

Scheduled maintenance	423
Seat adjustment, Front seats	26
Seat belt(s)	
- Child safety	40
- Injured persons	40
- Pre-tensioner seat belt system	60, 68
- Precautions on seat belt usage	38
- Pregnant women	40
- Seat belt cleaning	419
- Seat belt hooks	42
- Seat belt maintenance	42
- Seat belt warning light and chime	88
- Seat belts	38
- Shoulder belt height adjustment	41
Seat(s)	
- Heated seats	29, 32
- Memory seat	187
- Seats	26
Second row seats	30
Security system (NATS (NISSAN Anti-Theft System)), Engine start	172
Security system, Theft warning System	171
Servicing air conditioner	223
Shift position indicator	81
Shoulder belt height adjustment, For front seats	41
Side Driving Aids	245
SNOW mode	239
Soft bottle holders	140
Sonar	
- Parking sensor (sonar) system	377
- Rear Automatic Braking (RAB)	358
SOS button (See Emergency services call eCall/SOS system)	137
Spark plugs	432

Speed Limit Link			
- Models with ProPILOT Assist system (with Navi-link)	324		
- Models with ProPILOT Assist system (without Navi-link)	323		
- Models without ProPILOT Assist system	301		
Speed limiter	289		
Speedometer	79		
SPORT mode	240		
STANDARD mode	239		
Starting			
- Jump starting	407		
- Precautions when starting and driving	229		
- Push starting	409		
- Starting the e-POWER system	237		
Steering			
- Electric power steering	369		
- Steering wheel	180		
Steering Assist	331		
Steering Assist switch	332		
Steering wheel	180		
Stopping vehicle	404		
Storage	139		
Stowing damaged tyre and tools	453		
Sun visors	150		
Sunglasses holder	141		
Sunroof	148		
Sunshade (rear)	151		
Super Lock system	157		
Supplemental air bag system			
- Supplemental curtain side-impact air bag system	68		
- Supplemental side-impact air bag system	67		
Supplemental curtain side-impact air bag system	57, 68		
Supplemental front central side-impact air bag system	57		
Supplemental front-impact air bag system	57, 63		
Supplemental Restraint System (SRS)	57		
Supplemental Restraint System (SRS) air bag warning light	88		
Supplemental side-impact air bag system	57, 67		
Switch			
- Defogger switch	132		
- Drive Mode Selector	238		
- Emergency services call eCall/SOS system	137		
- EV mode switch	11		
- Fog light switch	128		
- Hazard warning flasher switch	402		
- Headlight switch	120		
- Memory switch	187		
- P position switch	241		
- Power door lock switch	158		
- Steering Assist switch	332		
- Turn signal switch	128		
- Wiper and washer switch	129		
T			
Theft (NATS (NISSAN Anti-Theft System)), Engine start	172		
Third row seats	33		
Three-way catalyst	230		
Tonneau cover	142		
Towing			
- Tow truck towing	410		
TPMS resetting	232		
TPMS, Tyre pressure monitoring system	231		
TPMS, Tyre pressure warning system	403		
Traffic Sign Recognition (TSR)	257		
Trailer brakes	366		
Trailer detection	367		
Trailer towing	366		
Transmitter, With Intelligent Key system (See Intelligent Key system)	168		
Trip computer	113		
Trip odometer	115		
Troubleshooting guide			
- Driver Assistance systems	250		
Turn signal switch	128		
Tyre			
- Emergency tyre puncture repair kit	403		
- Installing tyre	452		
- Preparing tools	450		
- Removing tyre	451		
- Repairing flat tyre	403		
- Stowing damaged tyre and tools	453		
Tyre pressure, Low tyre pressure warning light	87		
Tyres			
- Flat tyre	403		
- Low tyre pressure warning system	231		
- Types of tyres	447		
- Tyre age	448		
- Tyre chains	447		
- Tyre equipment	398		
- Tyre inflation pressure	447		
- Tyre placard	461		
- Tyre pressure	366		
- Tyre pressure monitoring system (TPMS)	231, 403		
- Tyre rotation	448		

- Tyre wear and damage	448
- Tyres and Wheels	447, 460
Tyres and Wheels	447

U

Underbody cleaning	417
Unlocking with inside handle	158
USB (Universal Serial Bus) charging connector	135

V

Vanity mirror	187
Vanity mirror lights	153
Variable voltage control system	440
Vehicle	
- Dimensions	460
- Electronic Stability Programme (ESP) system	372
- Identification number (VIN)	461
- Security system	171
Vehicle information display	92
- Settings	93
- Vehicle information display warnings and indicators	101
Vents	219
VSP system	12

W

Walk away lock function	164
Warning	
- Blind Spot Warning (BSW)	270
- Driver Assistance systems troubleshooting guide	250
- Hazard warning flasher switch	402

- Intelligent Forward Collision Warning	348
- Lights	84
- Low tyre pressure warning	105
- Rear Door Alert	133
- Tyre pressure monitoring system (TPMS)	231, 403
- Vehicle information display	92
- Warning lights, indicator lights and audible reminders	83

Warning light

- 12-volt battery charge warning light	84
- Air bag warning light	88
- Anti-lock Braking System (ABS) warning light	84
- Approaching Vehicle Sound for Pedestrians (VSP) warning light	84
- Brake system warning light (yellow)	84
- Brake warning light	85
- e-POWER system warning light	86
- Electric power steering warning light	86
- Electric shift control system warning light	86
- Low tyre pressure warning light	87
- Seat belt warning light and chime	88

Washer switch

- Rear window wiper and washer operation	130
- Wiper and washer switch	129

Washing	416
---------------	-----

Waxing	417
Wheel balance	449

Wheels and tyres

- Care of wheels	417
- Cleaning aluminium alloy wheels	417
- Tyres and wheels	460

Where to go for service	423
Window washer fluid	425, 437
Window(s)	
- Cleaning	417, 419
- Power windows	146
Wiper	
- Rear window wiper blade	436
- Wiper and washer switch	129
- Wiper blades	436
Wiper and washer switch	129
Wireless charger	135

GAS STATION INFORMATION

FUEL INFORMATION:

Petrol engine (model with three-way catalyst)



CAUTION

- Do not use leaded petrol. Using leaded petrol will damage the three-way catalyst.
- Never use fuel additives. Additives may cause damage to the engine.

Except for Ukraine:

Compatible fuels for petrol engines

The petrol engines are compatible with current and future European standards for bio-fuel.

	<p>Petrol conforming to EN228 and mixed with a bio-fuel conforming to EN15376.</p> <p>Maximum bio-fuel content in petrol allowed by engine is 10%.</p>
	<p>CAUTION</p> <p>Damage to fuel system or performance problem caused by the use of fuel with excessive ethanol content may not be covered by your new vehicle warranty.</p>

Use UNLEADED PREMIUM petrol with an octane rating of at least 95 (RON).

If unleaded premium petrol is not used, UNLEADED REGULAR petrol with an octane rating of at least 91 (RON) may be used at slightly reduced performance. However, for maximum vehicle performance and the best driveability, the use of unleaded premium petrol is recommended.

For Ukraine:

Use UNLEADED REGULAR petrol with an octane rating of at least 91 (RON).

RECOMMENDED ENGINE OIL

See "Recommended fluids/lubricants and capacities" (P.456).

TYRE COLD PRESSURE

See the tyre placard affixed to the driver's side centre pillar.

QUICK REFERENCE

- In case of emergency ... 401
(Flat tyre, e-POWER system will not start, overheating, towing)
- How to start the e-POWER system ... 225
- How to read the meters and gauges ... 71
- Maintenance and do-it-yourself ... 421
- Technical information ... 455

SECURITY INFORMATION

As owner of this vehicle important codes have been supplied to you that may be required by your NISSAN dealer to duplicate keys or repair the radio.

Please fill in the allocated areas or attach sticker(s) if available. Remove this page and keep it in a safe place, **not in the vehicle**.

When selling your vehicle, we kindly request you to hand over this page to the buyer.

SECURITY INFORMATION

Radio security code
(where fitted)

--	--	--	--

Key number

--	--	--	--	--

Wheel lock key code
(where fitted)

--	--	--	--	--	--	--	--

Remove this page from the manual and keep it in a safe place, **not in the vehicle**.

When selling your vehicle, we kindly request you to hand over this page to the buyer.

